

A photograph of two hands, one on the left and one on the right, gripping vertical metal prison bars. The hands are positioned as if they are holding onto the bars, with the fingers wrapped around them. The background is dark, and the bars are a dark, metallic color. The lighting highlights the texture of the hands and the bars.

The New Crow Jim

The Empowerment of the
Black Criminal Subculture

A.J. WEBERMAN

THE NEW CROW JIM

**& THE EMPOWERMENT OF THE BLACK
CRIMINAL SUBCULTURE**

©JANUARY 2018

INDEPENDENT RESEARCH ASSOCIATES

318 3rd AVENUE SUITE 520

NEW YORK, NEW YORK 10010

(212) 252-3383

ISBN-13:

9781534695207

ISBN-10:

1534695206

By A. J. Weberman

INTRODUCTION

Obama was and still is a Black Racist, and he tried to change *the fabric of America* from white to Black and Brown. He attempted to turn the melting pot into the patchwork quilt, change the racial makeup of society from White to non-White. Wiping out those of European descent became part of political correctness thanks to this racist Muslim pig: A political-science course called "Abolition of Whiteness" was open for 2017 fall enrollment at Hunter College in New York taught by Lecturer/Deputy Chairperson Jennifer Gaboury¹ who currently is working on a project related to race and sex segregation in public bathroom facilities. This author suggests that to complete her studies she needs a self-administered swirly. How can Hunter allow a course in genocide? It is white genocide so it is permissible. But if I said "Let's abolish all Jew hating America hating diesel dykes like Jennifer" I would be in deep dodo.



When Americans suddenly realized that a Black Racist was in the White House and that their nation was at stake, the Senate, House and two-thirds of State Legislatures turned Republican. You can rob people of their freedom, their homes and business, even their religion, but not their nationality, the USSR case in point.

1. 212-772-5559 Room: West 1716 jgaboury@hunter.cuny.edu

THE NEW CROW JIM

Now a white and a nationalist is president, who promises to insure America remains a nation made up of the demographic that made it democratic and prosperous. Obama was a rotten apple and they say one rotten apple spoils the barrel; put that rotten apple in the White House and spoil the world. But we now have the anti-Obama in there, a man who started his presidential campaign by questioning the authenticity of Obama's birth certificate in order to disqualify him from the presidency. Trump knew his birth certificate was real and the dog whistle here is that Obama was a nigger and judging from their track record a member of the Negro race should not be allowed to become President.

That track record is crime. Recently USAG Jefferson Sessions admitted that crime is down overall in the US but:

In the last two years, we've seen clear warning signs – like the first gusts of wind before a summer storm – that this progress is now at risk. The latest FBI official data tell us that from 2014 to 2015, the violent crime rate in the U.S. increased by more than 3 percent – the largest one-year increase since 1991. The murder rate increased 11 percent – the largest increase since 1968. The rape rate increased by over 4 percent and the aggravated assault rate rose by nearly 4 percent. If this was a one-year spike, we might not worry too much. But the preliminary data for the first half of 2016 confirmed these trends. The number of violent crimes in the first half of last year was more than 5 percent higher than the same period in 2015. The number of murders was also up 5 percent over the same period the year before, and aggravated assaults rose as well.

Just last week, the *Wall Street Journal* reported that since 2014, the murder rate in 27 of our country's 35 largest cities has gone up. Homicide rates in Chicago,

Baltimore, Milwaukee and Memphis have returned to levels not seen in two decades. Last year, Chicago had more than 4,000 shooting victims and 762 murders, and Baltimore's murder rate was its second-highest ever. These numbers should trouble all of us. My worry is that this is not a "blip" or an anomaly, but the start of a dangerous new trend that could reverse the hard-won gains of the past four decades – gains that made America a safer and more prosperous place. While this spike in violent crime is not happening in every neighborhood or city, the trends should concern all of us. It is a basic civil right to be safe in your home and your neighborhood. We are diminished as a nation when any of our citizens fears for their life when they leave their home; or when terrified parents put their children to sleep in bathtubs to keep them safe from stray bullets; or when entire neighborhoods are at the mercy of drugs dealers, gangs and other violent criminals. We've also heard from law enforcement leaders, including the FBI Director and many police chiefs that something is changing in policing. They tell us that in this age of viral videos and targeted killings of police, many of our men and women in law enforcement are becoming more cautious. They're more reluctant to get out of their squad cars and do the hard but necessary work of up-close policing that builds trust and prevents violent crime. This is a terrible place to be, because we know that tough and effective law enforcement can make a real difference. It can reduce crime and save lives.

We've seen it happen in our country over the past four decades – and many of you in this room have been part of this noble work. The immense social costs of crime are indisputable.

THE NEW CROW JIM

Yes, incarceration is painful for the families of inmates, and every conviction represents a failure on multiple levels of society. But the costs of rising crime are even more severe. Drug crimes and violent felonies change the lives of victims forever. Neighborhoods hit by rising crime suffer deep economic harm. And if more young men choose to commit crimes because jail time is less daunting than before, that means they are forgoing more hopeful courses for their lives and their communities. In the midst of a terrible heroin epidemic and a rise in violent crime, we should not roll back the tools law enforcement has to go after federal drug trafficking and firearms felons, or release thousands more.

The New Crow Jim documents Obama's treasonous Black Supremacist administration attempts to destroy America. As evidence it relies on court documents, executive actions, FBI documents, police documents, transcripts of speeches, as close to the initial source as this researcher can get without going into the hood at night. It is the best thing that has happened to the Black community for ages as it doesn't candy-coat the truth about the *Black Criminal Subculture* icons. Nor does it characterize blacks as children of clay molded by racism and poverty. It puts forth the "far-fetched notion" that some people aspire to be gangsters. It is only until Blacks realize this culture for what it is – self-defeating stupidity – that they can move on and put it behind them, rather than institutionalizing it.

HYPERLINKED TABLE OF CONTENTS

CHAPTER ONE: THE GREAT RACIAL DIVIDE AND BLACK LIVES MATTER

Seventy percent of Whites have no Blacks in their immediate social circles because of Black crime. Emmett Till was a thug. Black Lives Matter goal is to inspire cop killing and Obama is a card carrying supporter. Many cop executions inspired by group Obama praised. FBI Director Comey's strange tale; wherein he tried to frame someone when the Director was only 15.

CHAPTER TWO: OBAMA ASPIRED TO BE A HEROIN DEALER

Obama admitted to associating with heroin and cocaine dealers at the time he aspired to be a gangster. This indicates psychopathic tendencies. If you wanted someone right off the street to be president America could not have done better than Obama.

CHAPTER THREE: THE COP KILLING LOBBY'S MINISTER LOUIS FARRAKHAN

The Nation of Islam with its Black Nazi kill the Jews rhetoric was founded by a Sephardic dark skinned Jew, Wallace Fard, according to the widow of a Detroit Detective who investigated his cult. Fard ended up being fed to followers of Elijah Manammad. NOI followers believe in flying saucers and the Ebola was invented by Doctors Without Borders. Their Minister Louis Farrakhan is the titular leader of the Black Lives Matter cop killing movement. Obama is connected to them.

CHAPTER FOUR: THE EMPOWERMENT OF THE BLACK CRIMINAL SUBCULTURE

Blacks have demanded that stealing by underprivileged youth be decriminalized. Liberals are institutionalizing crime as form of political protest as long as they are not the victims. Black students are demanding their approximation to English be recognized as proper writing and speech. Obama makes excuses for black crime and blames it on the cops and the courts. Obama and Holder issued orders making it easier for black drug dealers to operate in America. The country is flooded with cheap heroin.

CHAPTER FIVE: OBAMA'S PLAN TO DISARM AMERICA

Obama wanted to confiscate all legal weapons as was done in Australia and leave decent people at the mercy of criminals who would act as surrogate revolutionaries equalizing the wealth.

CHAPTER SIX: FREDDIE GRAY MARTYR OF BLACK LIVES MATTER

Freddie Gray was a heroin dealer who was high on artificial marijuana when he died. The prosecutor in the case and her father and grandfather and cousins were all cop haters. The cops in this Black Lives Matter frame up were all acquitted. The riots that ensued were participated in by most of the African-American community.

CHAPTER SEVEN: 'BIG MIKE' BROWN MARTYR OF BLACK LIVES MATTER

The hands-up schtick was total mass hysteria among African-Americans or a collective attempt to lynch a police officer. It showed America what kind of mentally existed across the board in the Black community. The media stood behind the hands up story until the FBI debunked proving they are FALSE NEWS.

CHAPTER EIGHT: TAMIR RICE: MARTYR OF BLACK LIVES MATTER

Tamir Rice was a gang member and disturbed overgrown child whose friend removed the orange tip from a replica gun and gave it to him. He was terrorizing passersby's and sooner or later that replica would have turned real and he would use it.

CHAPTER NINE: *THE COP KILLING LOBBY* MEMBERSHIP

The Cop Killing Lobby wants to make it easier to kill cops. Though far removed from the thugs and isolated from crime the CEO of Ratner LLC, who built Barclay's arena in Brooklyn, is heavily involved. Obama set it off after Louis Gates framed a cop for false arrest by putting them both on the same level when he invited them to the White House. Communist organizations like Center for Constitutional Rights and their liberal fellow travelers in the ACLU support cop killing as do rap lyrics and the big corporations that promulgate them. Rap even made its way into the White House.

CHAPTER TEN: THE MEDIA AND THE *COP KILLING LOBBY*

The media promulgated the biggest FALSE NEWS STORY ever, the Michael Brown Hands UP BS. Media disconnected from the people and focuses on every incident involving a cop and a black but not on black on black or black on white crime.

CHAPTER ELEVEN: OBAMA'S RACIST ENTOURAGE

Obama was surrounded by some real scumbags because he is one himself.

CHAPTER TWELVE: ERIC "H. RAPP" HOLDER AUTHOR OF "THE NEW BLACK CODES"

THE NEW CROW JIM

Eric Holder was the first Black Panther United States Attorney General and he did all he could to empower the Black Criminal Subculture.

CHAPTER THIRTEEN: MASS INCARCERATION AND THE “NON-VIOLENT” DRUG OFFENDER

When it comes to heroin and crack there is no such thing as a non-violent dealer. What does Obama think these 7,000 prisoners will do after he pardons them? They will return to crime even more violent than before their incarceration.

CHAPTER FOURTEEN: THE AUTOCRAT

Obama’s Executive Orders making paying ransom to terrorists legal and long as it is done after consulting with a special committee. Obama’s associates include autocratic African dictators.

CHAPTER FIFTEEN: IMMIGRATION

Part of Obama’s plan to “Change the Fabric” of America meant filling it with Mexicans, giving them citizenship, so they will make the Democratic Party the only party. List of felonies you can plead down to a misdemeanor and remain in the United States including assault and burglary.

CHAPTER SIXTEEN: OBAMA’S RACIALIST AND PC HIRING PRACTICES

Obama’s hiring practices often come back on him via incompetence and scandal. CROW JIM: ONLY BLACKS NEED APPLY

CHAPTER SEVENTEEN: JEH CHARLES JOHNSON

The Head of Homeland Security with 2 years of law enforcement experience and stupid first name.

CHAPTER EIGHTEEN: OBAMA AND ISLAM: COINCIDENCE OR CONSPIRACY?

When Obama lived in Indonesia, he by his own admission, attended a mosque which means he said the Shahada, the Islamic Oath.

CHAPTER NINETEEN: THE CONSEQUENCES OF “NO BOOTS ON THE GROUND”

This Muslim mole turned the world over to radical Islamic terrorists and caused more refugees than any time since WWII.

CHAPTER TWENTY: OBAMA AND THE JEWS

Obama hates Jews and Israel just like any other street brother only he cool about it and pretends he loves them.

THE NEW CROW JIM

CHAPTER ONE

The Great Divider



Assuming the average white and average black American each have 100 friends, this is what their racial breakdown of their friend networks would look like.



The average **white** American has...



91 white friends



The average **black** American has...



83 black friends



THE NEW CROW JIM

The Public Religion Research Institute's (PEW) data conclusively shows that a full 75% of Whites have "entirely White social networks without any minority presence."² One reason people shy away from associating with African-Americans is Black crime. The United States has less than 5% of the world's population and but almost 25% of the incarcerated. More than a third of the prisoners are Black.

Every year, more than 600,000 inmates are released, according to the Justice Department. Most of them will return to crime. An estimated two-thirds (68 percent) of 405,000 prisoners released in 30 states in 2005 were arrested for a new crime within three years of release from prison, and three-quarters (77 percent) were arrested within five years, the Bureau of Justice Statistics (BJS). More than a third (37 percent) of prisoners who were arrested within five years of release were arrested within the first six months after release, with more than half (57 percent) arrested by the end of the first year. Associate with Blacks and the chances of coming into contact with these members of the Black Criminal Subculture increases. What are the possible consequences?

Forty-seven percent of Black Americans say they know someone who was fatally shot by another person, and 19 percent have lost a family member. In comparison, just 18 percent of White Americans said they know a victim of gun violence, and just 3 percent have lost someone in their family. No one wants to be one degree of separation away from psychopaths and their victims? So Americans stay in their own racially divided neighborhoods as they do in Chicago, New York. Black crime is why a state of *de facto* racial segregation still exists in America.

Although blacks comprised about one-fifth of the share of New York City's young men police data show they were responsible

2. <https://wpo.st/gbPf2>

for three-quarters of all the gun violence. As a result, young black men are more likely to be exposed to an oppositional street culture that this researcher terms The Black Criminal Subculture — one that not only endorses violence as means of resolving beefs, but also contributes to a social environment where firearm violence is the norm. The Obama Administration wanted to put an end to this *de facto* segregation without dealing with the issue of Black crime, Urban Decay and Urban Blight.

This put everyone in danger, not just Afro-Americans. Obama wanted to spread the misery around to Whites because Obama was a Black racist President. America has had no shortage of White racist presidents so why not a Black one? During the Lincoln-Douglas debate Lincoln stated:

My first impulse would be to free all the slaves, and send them to Liberia, to their own native land. But a moment's reflection would convince me, that ***whatever of high hope, (as I think there is) there may be in this,*** in the long run, its sudden execution is impossible.³

A southerner, President Woodrow Wilson had been president of Princeton, the only major northern university that refused to admit Blacks. He was an outspoken White supremacist – his wife was even worse and told "darkie town" stories in cabinet meetings. His administration submitted a legislative program intended to curtail the civil rights of African Americans, but Congress didn't pass it. Wilson used his power as chief executive to segregate the federal government. He appointed southern Whites to offices traditionally reserved for Blacks. Wilson personally vetoed

3. <http://www.nps.gov/liho/learn/historyculture/debate1.htm>

THE NEW CROW JIM

a clause on racial equality in the Covenant of the League of Nations. Recently African-American students at Princeton have been demanding that Wilson's name be removed from the Woodrow Wilson International Center for Scholars. They will have plenty of time for protest since 91 percent of the school's black students graduating within **six years** of enrollment⁴ and most of them are there because of one of the New Crow Jim's New Black Codes euphemistically known as affirmative action.

President Coolidge, "America must be kept American. Biological laws show that Nordics deteriorate when mixed with other races."⁵ President Herbert Hoover was a moving force behind the America First Committee, a Nazi front group. After he left the Presidency Hoover met with Adolf Hitler.⁶

President Dwight Eisenhower had this to say about segregationists. "These are not bad people. All they are concerned about is to see that their sweet little girls are not required to sit in school alongside some big overgrown Negroes."⁷

So why not Obama? As a result of our first Black Racist president and the hatred he stirred up although overall deaths of law enforcement officers were down, the number killed in ambushes simply because they are cops is up. Thanks to Obama and Holder - Michael Brown, Freddie Gray and Tamir Rice have been made into heroic martyrs like Emmett Till.

4. <http://amherststudent-archive.amherst.edu/current/news/view.php?year=2000-2001&issue=14§ion=news&article=03>

5. Calvin Coolidge, "Whose Country is This?" *Good Housekeeping*, February 1921

6. http://www.jstor.org/stable/41212096?seq=1#page_scan_tab_contents

7. http://www.digitalhistory.uh.edu/disp_textbook.cfm?smtID=3&psid=1120

A. J. WEBERMAN

This criminal worship spawned the *Black Lives Matter* movement which is really about the institutionalization of criminality. In other words criminality is so widespread in the Black community that most humane way of dealing with it in relation to the people committing crimes is to prevent the police from interfering with their behavior by arresting or shooting them.

Their strategy is working. Mayor Rob Emmanuel of Chicago stated that the spike in murders in his city was due to cops “assuming the fetal position” thanks to Black Lives Matter. The psychopath, destructive and often fatal to the Black community, becomes a hero of the Black community. That is how twisted this thinking is, and it is considered mainstream.

EMMETT TILL WAS A THUG

This editorial, written by Charles Blow, smirking, appeared in the *New York Times*:



Before Trayvon Martin, before Michael Brown, before Tamir Rice, there was **Emmett Till**. This was the first '**Black Lives Matter**' story. It is no wonder, then, that each time we read about **another young unarmed Black male being shot down in the street unjustly by an authority figure**, there is the mention of **Emmett's** name.

What we come to see with the loss of **Emmett** is just what racism has cost us in this country. What it costs us still, in the loss of so many bright, gifted kids. Partly through untimely deaths. But also in the limited opportunities many have to excel, because of mass incarceration or even **unwarranted tracking in schools**.⁸

Thanks partially to a **Bob Dylan song**, legend has it that after moving from Chicago to Mississippi Emmett Till allegedly ogled or wolf whistled at a White woman, Carolyn Bryant Donham, during a chance meeting in the street and, as a result, was castrated then beaten to death. But this was not the case. There was what is now considered by liberals sexual assault involved.

Till was kidnapped days later from a relative's home and then beaten and mutilated, before being shot, by Donham's shop-owner husband at the time, Roy Bryant, and his half-brother, J. W. Milam. Till's body was sunk in the Tallahatchie River, where it was eventually found floating. An all White jury acquitted his assailants. Donham, under pressure from a liberal college professor recanted the molestation claim but her book, to be released after her death, is entitled *More Than Just a Wolf Whistle*. I would go with the court transcript because most of her customers at the store were black so why alienate them by making up a story?

8. http://www.nytimes.com/2015/08/31/opinion/charles-m-blow-60-years-later-echoes-of-emmett-tills-killing.html?ref=todayspaper&_r=0

Q. Just tell the Court what happened there at that time, please, ma'am.

A. This nigger man came in the store and he stopped there at the candy case.

Q. Now, is the store, with reference to that candy counter, is there anything back of the candy counter towards the wall of the Store?

A. No.

Q. Is there any place to walk there or anything of that sort?

A. Yes, an aisle.

Q. When this negro man came in the store, where were you in the store?

A. I was farther back in the store, behind the counter.

Q. And when he came in, I believe you said he stopped in front of the candy counter, is that right?

A. Yes.

Q. And what did you do then?

A. I walked up to the candy counter.

Q. And what transpired up there at the candy counter?

A. I asked him what he wanted...I got it and put it on top of the candy case. I held my right hand out for his money.

Q. Will you show the Court how you held your hand out?

THE NEW CROW JIM

A. I held out my hand like this (demonstrating by holding out her hand).

Q. And did he give you the money?

A. No.

Q. What did he do?

A. He caught my hand.

Q. Will you show the Court just how he grasped your

A. Like this (demonstrating with her hand).

Q. By what you have shown us, he held your hand by grasping all the fingers in the palm of his hand, is that it?

A. Yes.

Q. And was that a strong grip or a light grip that he had when he held your hand?

A. A strong grip.

Q. And will you show the court what you did? How did you get loose?

A. Well, I just jerked it loose, like this (demonstrating).

Q. It was about that difficult to get loose, was it?

A. Yes.

Q. And it was with that much difficulty that you got your hand loose?

A. Yes.

Q. Just what did he say when he grabbed your hand?

A. He said, "How about a date, baby?"

Q. When you freed yourself, what happened then?

A. I turned around and started back to the back of the store .

Q. You did what?

A. I turned to get to the back of the store.

Q. Did you do anything further then?

A. Yes. He came on down that way and he caught me at the cash register.

Q. You say he caught you?

A. Yes ..

Q. How did he catch you?

A. Well, he put his left hand on my waist, and he put his other hand over on the other side.

Q. How were you going down along the counter there? Did he approach you from the front, or from the rear or how?

A. From the side.

Q. Now, Mrs. Bryant, will you stand up and put my hands just where he grasped you? Will you show the Court and jury?

THE NEW CROW JIM

A. It was like this (demonstrating by putting Mr. Carlton's hands on her body).

Q. He grabbed you like that, did he?

A. Yes.

Q. In other words, with his left arm around your back?

A. Yes.

Q. And his left hand on you left hip?

A. Yes.

Q. And he had his right hand on your right hip?

A. Yes.

Q. Did he say anything to you then at the time he grabbed you there by the cash register?

A. Yes.

Q. What did he say?

A. He said, "What's the matter, baby? Can't you take it ? 11

Q. He said, "What's the matter, baby?"

A. Yes.

Q. Did you then try to free yourself?

A. Yes.

Q was it difficult? Did you succeed?

A. Yes.

Q Did he say anything further to you?

A. Yes.

Q. What did he say?

A. He said, "You needn't be afraid of me

Q. And did he then use language that you don't use?

A. Yes.

Q. can you tell the court just what letter that word begins begins with?

A. (The witness did not answer verbally, but shook her head negatively.)

Q. In other words, it is an unprintable word?

A. Yes.

Q. Did he say anything after that one unprintable word?

A. Yes.

Q. And what was that?

A. Well, he said well "With white women before."

THE NEW CROW JIM

Q. When you were able to free yourself from him, what did you do then?

A. Then this other nigger came in the store and got him by the arm.

Q. And what happened then?

A. And then he told him to come on and let's go.

Q. Did he leave the store willingly or unwillingly?

A. Unwillingly.

Q. How did the other negro get out of the store then? How did they leave?

A. He had him by the arm and led him out.

Q. Were there any white men in the store at the time this occurred?

A. No,

Q. Were there any other negro men in the store at the time?

A. No.

Q. Were there any other persons outside the store?

A. Yes.

Q. Were they white men or colored men?

A. Colored.

Q. Were there a number of them out there? How many of them were out there?

A. Oh, about eight or nine.

Q. When he went out the door, did he say anything further after he had made these obscene remarks?

A. Yes. He turned around and said, "Good-by."

Q. And when he got out the door, what did you do?

A. I called to Mrs. Milam to watch me and then I ran out the door to go to the car.

Q. Which car did you go to?

A. Mrs. Milam's.

Q. What did you go to the car for?

A. For my pistol.

Q. Where was your pistol in the car?

A. Under the seat.

Q. It was under which seat?

A. The driver's seat.

Q. As you went out the door and went to the car, did you see this man again?

A. Yes.

Q. Where was he then? Where was he standing?

THE NEW CROW JIM

A. He was standing by one of the posts on the front porch.

Q Your store has a front porch to it?

A. Yes.

Q. And these posts are on the front porch?

A. Yes.

Q. Did he say or do anything at that time?

A. He whistled and then came out in the road;

Q. Can you give a sound something like the whistle that he made there? Was it something like this? (Mr. Carlton demonstrated by giving two low whistles.)

A. Yes.

Q. When you got your pistol, Mrs. Bryant, where was this boy then? Or I should say where was this man?

A. When I turned around, he was getting in a car down the road.

Q. Did you rush back in the store then?

A. Yes.

Q. Had you ever seen that man before?.

A. No.

Q Have you ever seen him since?

A. No.

Q. Tell us what size man he was. Describe about how tall he was.

A. He was about five feet, six inches tall.

Q. And that is about four inches taller than you are, is that right?

A. Yes.

Q. And how much would you say that he weighed?

A. Around one hundred and fifty pounds.

Q. What sort of impression did this occurrence make

A. I was just scared to death.

Q. Mrs. Bryant, do you generally know the negroes in that community around Money?

A. Yes.

Q. What kind of store is it that you run there?

A. Just a general store.

Q. Are most of your customers negroes or white people?

A. Most of them are negroes.

Q. And of course, you come in contact with most of the negroes around there in that way?

A. Yes.

Q. And you know most of them around there, do you?

THE NEW CROW JIM

A. Yes.

Q. And was this man one of those?

A. No.

Q. Did he talk with a southern or northern brogue?

A. The northern brogue.

Certain things bother me about Bryant's testimony. When Till said he had sex with white women before I wonder if he meant raped them, because that seems to his idea of making love. Could that be the reason him and his moms left Chicago for Mississippi? Louis Till, Emmet's father, was serving overseas in the Transportation Corps of the U.S. Army during World War II. The army was still segregated at the time, and he and another African-American private, Fred McMurray, were found guilty by an army court-martial of raping two Italian women and murdering one during an air raid in 1944.

Assuming Mrs. Bryant is telling the truth, there are certain similarities between recent controversial racially charged events and Emmet Till. Before Big Mike Brown tried to kill a police officer he committed a strong arm robbery in a convenience store. Emmet never paid for candy and assaulted the clerk. The Cuyahoga County Medical Examiner released the autopsy of 12-year-old Tamir Rice, shot by a Cleveland police officer Nov. 22, 2014. The report showed Tamir stood 5 feet 7 inches tall and weighed 195 pounds. Till was fourteen when he was murdered. But Till never tried to kill a cop like Michael Brown did nor did he point a replica gun at a police officer as Tamir Rice did. Like his rapist father, he was guilty of sexual assault, which the cracker courts and cops could have handled had his victim filed a complaint. But these KKK vigilante

scum had to lynch him and mutilate him. None-the-less I find it odd that this icon of the civil rights movement committed a criminal act.

Blow then made it seem as if Black youth are being mowed down by the police in large numbers rather than being killed by other Blacks which is simply a total distortion of the facts. Black on Black crime takes about 6,000 lives a year while about 200 Blacks are killed by White cops.⁹ *Blow*, who appropriately enough is bisexual, refers to “unwarranted tracking” in schools. If Blacks students can’t conform to the rules of conduct than the rules of conduct must be changed to accommodate their behavior at the expense of the rest of the class. This is a recurrent theme of the Black racists to give more latitude to pathological behavior or institutionalize it. If African-Americans can’t obey the law, the laws must obey African-Americans. None of the American-African criminals that Black Lives Matter idolizes, demonstrates and riots for deserves adulation.



9. https://www.fbi.gov/about-us/cjis/ucr/crime-in-the-u.s/2013/crime-in-the-u.s.-2013/offenses-known-to-law-enforcement/expanded-homicide/expanded_homicide_data_table_6_murder_race_and_sex_of_victim_by_race_and_sex_of_offender_2013.xls

THE NEW CROW JIM

None-the-less Obama is a member of the BLM Movement and has stated:

I want to drive home one point, and that is the relationship between race and the criminal justice system, because this is where sometimes politics intrudes. ***“Black Lives Matter”*** is a social media movement that had tried to gel around Ferguson and the Eric Gardner case and some other cases that came up. ***And very rapidly, it was posited as being in opposition to the police.*** And sometimes, like any of these loose organizations, some people **pop off** and say dumb things.

Black Lives Matter types fall into several categories. Leftists who believe capitalism has created The Black Criminal Subculture, Black racists who hate whites and Black Criminal Subculture members who don't dig getting busted. “And very rapidly, it was posited as being in opposition to the police.” Of course it is in opposition to the police otherwise there would be demonstrations every time a black killed a black or a black baby. One of the popular slogans of the Black Lives Matter Movement is **“Pigs in a blanket / Fry ‘em like bacon!”** or in Black Panther lingo OFF THE PIG! But that is only of minor concern to Obama. He considers this “popping off” But what does he mean by this? pop 7. To shoot a firearm, such as a pistol. So some people shoot cops and say dumb, slow to understand, dim witted, not psychopathic, things. They are making threats against the lives of police officers and it is more than dumb, it is inciting murder. Ismaaiyl Brinsley popped off and popularized the phrase Pigs in a Blanket. He also popped off and killed two New York City policemen. His Facebook page:

The image shows a screenshot of a social media post and its replies. At the top, a user named **dontrunup** has a profile picture of a man in a cap and a blue "Follow" button. The post is from 4 weeks ago and contains the following text: "Since A Lot Of People On Social Media Love To Join In On Challenges, I'm Inviting You All To Join My New Challenge Called #BTF Challenge. Yes #BTF Stands For "Burn The Flag". This Is For A Good Cause Such As Rasing Awareness About The Unjust Treatment Towards Our People In America. We've Been Treated As Subhumans For So Long It Is Even Looked Over By Some Of Our Own People." Below the post, a heart icon indicates that **umishura._**, **donjulio3000**, **tonymontana_211** and 10 others like this. The replies section shows several users: **dontrunup** with the hashtag #BurnTheFlag; **the_ramayana** with the text "Omg omg omg yaaaahs thank you!!!! @dontrunup"; **mullerstcyr** with the hashtags #BTF #BurnTheFlag; **the_ramayana** with the text "@that_halcyon_girl"; **the_ramayana** with the text "@bashinglyscots"; and **kirmett** with the text "Your all fucking animals. And animals get put down." At the bottom, there is a heart icon, a text input field with the placeholder "Leave a comment...", and a three-dot menu icon.

dontrunup Follow

4 weeks ago

Since A Lot Of People On Social Media Love To Join In On Challenges, I'm Inviting You All To Join My New Challenge Called #BTF Challenge. Yes #BTF Stands For "Burn The Flag". This Is For A Good Cause Such As Rasing Awareness About The Unjust Treatment Towards Our People In America. We've Been Treated As Subhumans For So Long It Is Even Looked Over By Some Of Our Own People.

♥ **umishura._**, **donjulio3000**, **tonymontana_211** and 10 others like this.

dontrunup
#BurnTheFlag

the_ramayana
Omg omg omg yaaaahs thank you!!!! @dontrunup

mullerstcyr
#BTF #BurnTheFlag

the_ramayana
@that_halcyon_girl

the_ramayana
@bashinglyscots

kirmett
Your all fucking animals. And animals get put down.

♥ Leave a comment...

THE NEW CROW JIM



dontrunup

Follow

4 hours ago · 📍 Brooklyn, New York

Never Had A Hot Gun On Your Waist And Blood On Your Shoe..... Nigga You Ain't Been Through What I Been Through You Not Like Me And I'm Not Like You. #BrooklynGoHard #ConeyIsland

👍 therealfab_ lawman31 chymillionaire and 9 others like this.



dontrunup

Follow

4 hours ago · 📍 Brooklyn, New York

I'm Putting Wings On Pigs Today. They Take 1 Of Ours..... Let's Take 2 of Theirs #ShootThePolice #RIPerivGardner #RIPMikeBrown This May Be My Final Post 000000000000 I'm Putting Pigs In A Blanket





dontrunup

Follow

5 months ago

#TBT You Better Have Allah On Your Side If You Ever..... Ever Plan On Violating Me. 🏴‍☠️🏴‍☠️

♥️ dontrustem, miss_oceana, sung0ddess and 2 others like this.



dontrunup

C.H.C.



dontrunup

@beverlykills__ @mulinaire I'll Find Out For Sure Tomorrow When I Head To Al-Farooq Tomorrow Inshallah

THE NEW CROW JIM

Brinsley did what he did because of the toxic atmosphere created by the accidental death of Eric Garner and the death of Michael Brown after Brown attempted to murder Darren Wilson. Obama:

And on the other hand, though, it started being lifted up as these folks are opposed to police and they're opposed to cops, and all lives matter.

This makes no sense. BLM became popular by going after the cops, making heroes out of attempted cop killers like Michael Brown followed by the non-sequitur "and all lives matter." Obama continued:

So the notion was somehow saying **Black Lives Matter** was *reverse racism*, or suggesting that other people's lives didn't matter, police officers' lives didn't matter.

Reverse Racism? Obama means Black Racism. He knows what the BLM Movement is really about.

And whenever we get bogged down in that kind of discussion, we know where that goes. That's just down the old track. So let me just suggest this. I think everybody understands all lives matter. Everybody wants strong, effective law enforcement. Everybody wants their kids to be safe when they're walking to school. Nobody wants to see police officers, *who are doing their job fairly*, hurt.

What about the police officers who are not doing their job fairly, who are targeting Blacks, do they deserve to be shot or killed. Yes, according to Obama. Like his "popped off" remark he is advocating cop killing.

A. J. WEBERMAN

Everybody understands it's a dangerous job. I think the reason that the organizers used the phrase "Black Lives Matter" was not because they said they were suggesting nobody else's lives matter; rather, what they were suggesting was there is a specific problem that is happening in the African American community that's not happening in other communities. And that is a legitimate issue that we've got to address. The African American community is not just making this up.

They are not making it up like they made up the hands up lie in the Ferguson, Wilson, Brown affair. Obama added that those who claim that black people are disproportionately subject to excessive force by police "back it up with data, not anecdote".

So? Blacks don't commit more crime than other groups but are targeted and framed by White cops. There is no indigenous Black Criminal Subculture; there are no Crypts or Bloods.



THE NEW CROW JIM

Obama is a card carrying member of Black Lives Matter who believes Blacks don't commit more crime but are singled out by police. He said Black Lives Matter was part of a "very long story"¹⁰ beginning with slavery, Jim Crow etc. making an excuse for potential cop killers. He is street scum like his brothers. Governor Chris Christie had his to say about Black Lives Matter:

Yet you see murder is up 19 percent in Chicago and up 11 percent in New York, and the murder of a police officer. The problem is this. There's lawlessness in this country. The president encourages this lawlessness. He encourages it by his own rhetoric. He does not support the police. He doesn't back up the police. He justifies Black Lives Matter. I mean... Listen, I don't believe that that movement should be justified when they're calling for the murder of police officers, no. Sure, they are. Sure, they are. They have been chanting in the streets for the murder of police officers.

Face the Nation host John Dickerson interjected: "Well, individuals have, but the Black Lives Matter is about..." and Christie responded:

Well, but, listen, you know, John, that's what the movement is creating. And the president of the United States is justifying that, but not only that. He hasn't backed up police officers from the minute he's gotten into office.

By this time many people are aware of the fact that Black lives do not really matter to Black Lives Matter because the group never demonstrates against Black on Black crime.

10. <http://www.today.com/video/obama-black-lives-matter-movement-is-part-of-a-very-long-story-557959747707>

A. J. WEBERMAN

Black Lives Matter is a coalition of cop haters from all across the racial and political spectrum who want to see cops dead. To justify this they point to the Blue Wall of Silence and the fact that cops lie when they feel someone is guilty but might be acquitted. A lot of them have been arrested which doesn't endear one to the cops. None-the-less if it a choice between a sometimes flawed police force and a bunch of dumb thugs determined to make life unlivable for others, I'll take civilization and the cops.

Many young Whites have participated in Black Lives Matter demonstrations who would never think of going out and offing a pig. They are digging their own graves. If the shootings keep increasing as the chart below indicates, it is bound to spread to White neighborhoods in which I presume these White Black Lives Matter supporters live, and they or their children might be put at risk.

| | 2014 | 2015 |
|------------------|------|------|
| Milwaukee | 59 | 104 |
| St. Louis | 85 | 136 |
| Baltimore | 138 | 215 |
| Washington | 73 | 105 |
| New Orleans | 98 | 120 |
| Chicago | 244 | 294 |
| Kansas City, Mo. | 45 | 54 |
| Dallas | 71 | 83 |
| New York | 190 | 208 |
| Philadelphia | 165 | 171 |

THE NEW CROW JIM

These are just deaths not wounding. Some attribute this rise in homicides to the “Ferguson Effect.” The reluctance of police to have their lives ruined and possibly end up in a cage 23 hours a day if the Black community tries to frame them like it did to Darren Wilson. FBI Director Comey agrees:

I fear we are facing another wave of violent crime and homicide, and our communities are once again in trouble. And the trouble is complicated, layered, and painful. I imagine two lines: one line is law enforcement and the other line is the folks we serve and protect, especially in communities of color. I think those two lines are arcing away from each other, at an increasing rate.

Each incident that involves real or perceived police misconduct drives one line this way. Each time an officer is attacked in the line of duty, it drives the other line this way. I actually feel the lines continuing to arc away from each other, incident by incident, video by video, more and more quickly. And that’s a terrible place to be. And just as those lines are arcing away from each other—and maybe because they are arcing away—we have a crisis of violent crime in some of our most vulnerable communities across the country. I spoke to officers privately in one big city precinct who described being surrounded by young people with mobile phone cameras held high, taunting them the moment they get out of their cars. They told me, “We feel like we’re under siege and we don’t feel much like getting out of our cars.” I’ve been told about a senior police leader who urged his force to remember that their political leadership has no tolerance for a viral video. So the suggestion, the question that has been asked of me, is whether these kinds of things are changing police behavior all over the country.

And the answer is, I don't know. I don't know whether this explains it entirely, but I do have a strong sense that some part of the explanation is a chill wind blowing through American law enforcement over the last year. And that wind is surely changing behavior.

We can't lose sight of the fact that there really are bad people standing on the street with guns. The young men dying on street corners all across this country are not committing suicide or being shot by the cops. They are being killed, police chiefs tell me, by other young men with guns.

Lives are saved when those potential killers are confronted by a strong police presence and actual, honest-to-goodness, up-close "What are you guys doing on this corner at one o'clock in the morning?" policing. All of us, civilian and law enforcement, white, black, and Latino, have an interest in that kind of policing.

We need to be careful it doesn't drift away from us in the age of viral videos, or there will be profound consequences. If we are not careful, we will lose the space in American life to talk about criminal justice reform—to focus on recidivism and re-entry and sentencing reform—and to talk about effective police interactions with civilians, all of which are essential.

In a way, those conversations are a welcome luxury, made possible by the fact that—as of 2014—we have a violent crime rate we haven't seen in 50 years. If what we are seeing in America this year continues, we will be back to talking about how law

THE NEW CROW JIM

enforcement needs to help rescue black neighborhoods from the grip of violence. ***All lives matter*** too much for us to let that happen. We need to figure out what's happening and deal with it now.



NEEDS SIGN “WIDE LOAD” ON BACKSIDE

Obama denied crime had risen under his Black Racist Administration:

I know that there's been some talk in the press about spikes that are happening this year relative to last year, and I've asked my team to look very carefully at it -- Attorney General Lynch has pulled together a task force -- and it does look like there are a handful of cities where we're seeing higher-than-normal spikes. Across the 93 or 95 top cities, it's very hard to distinguish anything statistically meaningful.

Comey was United States Deputy Attorney General from December 2003 to August 2005 under John Ashcroft. As Deputy Attorney General, Comey was the second-highest-ranking official in the

A. J. WEBERMAN

United States Department of Justice (DOJ), and ran the day-to-day operations of the Department.

In September 2000 Ashcroft spoke before The Council of Conservative Citizens, headquartered in St. Louis, a living legacy of Southern “white resistance” to desegregation, with historical roots in the so-called citizens councils that sprang up during the 1950s as a “respectable” support group for the Klan. Its website currently proclaims that the CCC is “the only serious nationwide activist group that sticks up for white rights!” What that means, more specifically, is promoting hatred of blacks, Jews, gays and lesbians, and Latino immigrants while extolling the virtues of the “Southern way of life,” the Confederacy and even slavery. Ashcroft was a frequent contributor to a neo-confederate publication the *Southern Partisan*.

Founded in 1985 by the ax handle-wielding Georgia segregationist Lester Maddox and a group of white activists, the CCC remained obscure to most Americans until 1998, when media exposure of its ties to prominent congressional Republicans led to the resignation of Sen. Trent Lott of Mississippi as majority leader. Six years later, the Southern Poverty Law Center reported that the CCC had hosted as many as 38 federal, state and local officials at its meetings (all of them Republicans, except one Democrat). When President George W. Bush appointed Ashcroft as U.S. attorney general, the CCC openly celebrated, declaring in its newsletter, “Our Ship Has Come In.”

COMEY AND RUDY GIULIANI

In 1987, Comey was hired as an assistant U.S. Attorney in New York’s Southern District by then-boss Rudy Giuliani. By this time, everyone knows Rudy is a crypto-racist. He has come out of the closet.

THE NEW CROW JIM

Asked what advice he would give to a black son: "I'd also say, be very careful of those kids in the neighborhood and don't get involved with them because, son, there's a 99 percent chance they're going to kill you, not the police. And we've got to hear that from the black community. And what we've got to hear from the black community is how and what they are doing among themselves about the crime problem in the black community."

Giuliani said Black Lives Matter is "inherently racist" and suggested the movement should focus on black people killing other black people. During an interview with CBS News' Face the Nation Giuliani said the Black Lives Matters movement focuses too much on police killing black people, which "happens rarely although with tremendous attention," and not enough effort focusing on black-on-black violence, "which happens every 14 hours in Chicago."

Little known fact about James is that after Comey's parents moved to New Jersey a white man dubbed "the Ramsey rapist" held 15-year-old Comey and his younger brother at gunpoint after breaking into their Allendale home on an October day in 1977, one of a string of break-ins that included the rape of two area baby sitters. The Comey brothers, locked in a bathroom while the intruder searched the home, escaped through a window, only to encounter the man again on their lawn. The brothers ran back inside the house, locked the doors and called police, setting off a massive manhunt. The cops suspected that Bruce A. Ader was the rapist and had a tracker follow his footprints to his brother's home.

After his victims were displayed a picture of him they ID'd him and he was arrested. But when they saw Ader in a police lineup only one of his alleged victims could identify him, little Jimmy Comey. Ader testified before a grand jury and it failed to indict. His alibi was a good one – he was with two friends at a bus station bar where his wife worked as a school bus driver. Ader was born in Morristown, N.J. in 1938. Bruce worked in the International Union of Operating Engineers 825.



The New York Times/Carl T. Gossett

Bruce A. Ader with his wife, Carol, and son, Bruce, after release yesterday



SKETCH OF RAPIST

Upon retiring they relocated to Lowell, North Carolina. Mr. Bruce was a friendly guy - "The unofficial mayor of River Falls" who sat on the front porch in his rocking chair along with his wife and dog waving to everyone who passed by. What does this tell us about Comey?

THE NEW CROW JIM

On August 28, 2015 Shannon Jaruay Miles, a Blackman, executed Darren Goforth, a White Peace Officer who was engaged in the lawful discharge of an official duty by shooting Goforth 15 times in the head and back. What could have possibly have been Miles' motive? The answer is he did it to become a cop killing hero in the African-African community. If not for this act what would Shannon Miles have been? He would have been nothing but someone who drifted between homelessness and fast food jobs, who beat an assault charge by feigning insanity then suddenly recovering six months later. Harris County Texas Sheriff Hickman attributed the killing to Black Lives Matter. Hickman:

When the rhetoric ramps up to the point where calculated, cold-blooded assassinations of police officers happen, this rhetoric has gotten out of control. We've heard, 'Black Lives Matter.' All lives matter. Well, cops' lives matter, too. So why don't we just drop the qualifier and just say, 'Lives matter,' and take that to the bank?

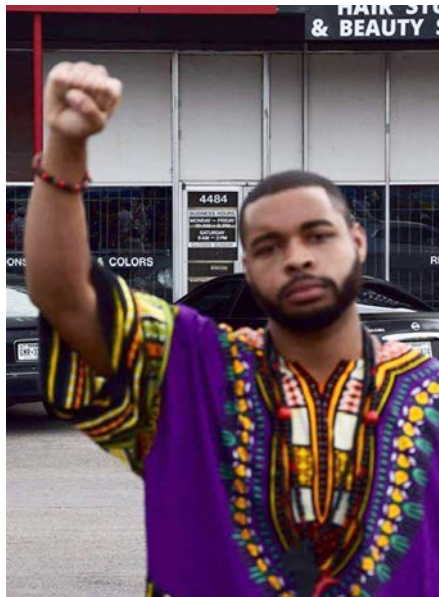

The sniper who shot a dozen Dallas police officers, Micah Xavier Johnson, killing five, was an Army veteran and a "loner" who had no criminal record but a pile of weapons and bomb-making materials in his house. He left the Army Reserve in 2015, nine months after returning from a deployment to Afghanistan. He was working as an aide for mentally challenged children and adults when the Black Lives Matter rhetoric radicalized him in July 2016. He committed this mass murder at a Black Lives Matter demonstration so there is no doubt about his motivation. More blood on Obama's hands.

The daughter of self-mutilation freak Bruce Jenner, was part of a **commercial** produced by the *Pepsi Cola Company* that glorifies the BLM group. It is full of beardless African American Muslims and a Muslima who is a photographer rather than a housewife.



A large cast of protesters, carrying Peace Signs from the 1950's and Love signs from the 1960's march claiming to be "the chosen" a subtle insult to Jews. Although they are not carrying Pigs in a Blanket signs it is obvious they represent BLM. That's combined with White girls giving gang signs.

THE NEW CROW JIM



Next you have to throw in a few transvestites, transsexuals; it is unclear what they are.



Finally Kendall Jenner, who is modeling, joins the patchwork quilt of future America, and gives the cop a Pepsi. The moral of the story is that a broad coalition of America should coalesce around BLM a cop hating group.

A. J. WEBERMAN

Kowtowing to African-Americans was part of Pepsi's marketing strategy. In the 1940's, Walter Mack became the President of Pepsi-Cola, where he aimed Pepsi-Cola at African Americans to increase sales, as soda for African Americans was an untouched gap in the market. After a couple of years – and many problems – he hired Edward F. Boyd to run the campaign where he led a team of black people around the country to promote Pepsi. During this time, Edward Boyd's team received a lot of racial discrimination, from insults by Pepsi co-workers, to threats by the Ku Klux Klan. During this campaign, they visited Chicago, where the sales of Pepsi overtook Coca-Cola for the first time. [Even now, after a hard night of gangin' and bangin' many African American Chicagoans still prefer the taste of Pepsi to Coke.] The only problem with the advertising campaign was that by directly aiming Pepsi at black people, they were cutting out everyone else, which is not what they intended to do, as a result, once Walter Mack left the company in 1950, the black sales team was discarded [or assigned the janitorial team]. In the 1970's Pepsi was run by Nixon associate Donald Kendall, who promoted the National Urban League, the most conservative of the major civil rights advocacy groups.



PEPSI ON TAP

CHAPTER TWO

OBAMA ASPIRED TO BE A HEROIN DEALER

Obama reflected on his past:

After a couple of years in college I started realizing that there were some things that were important to me; having an impact on social justice issues; having something to say about **poverty or race** or things like that. Yeah. These are the contradictions I had to work out so I... My mother was the biggest influence in my life and she was a wonderful woman but I am raised without a dad, an African-American but not grounded in a place with a lot of African-American culture. And so I am trying to figure out... I am seen and viewed and understood as a Black man in America but what does that mean? I am absorbing all kinds of stereo types from society like Shaft and so I am trying on a whole bunch of outfits; here's how I should act; here's what it means to be cool; here's what it means to be manly; you start smoking; you start drinking coffee; you get a leather jacket and then at a certain point right around 20 right around my sophomore year I started figuring that a lot of the ideas I had taken on about being a rebel **or being a tough guy or being cool** were really not me, they were just things I was trying on because I was insecure or because I was a kid.

What did Obama mean about being a tough guy and being cool? Shaft was a cinematic Black gangster. Why bring him into it? Did Obama aspire to being a gangbanger who dealt some cool stuff like coke or junk at one point in his life? Obama:

I blew a few smoke rings, remembering those years. Pot had helped, and booze; maybe a little blow when you could afford it. Not smack, though—Micky, my potential initiator, had been just a little too eager for me to go through with that. Said he could do it blind-folded, but he was shaking like a faulty engine when he said it. Maybe he was just cold; we were standing in a meat freezer in the back of the deli where he worked, and it couldn't have been more than twenty degrees in there. But he didn't look like he was shaking from the cold. Looked more like he was sweating, his face shiny and tight. He had pulled out the needle and the tubing, and I'd looked at him standing there, surrounded by big slabs of salami and roast beef, and right then an image popped into my head of an air bubble, shiny and round like a pearl, rolling quietly through a vein and stopping my heart....Junkie.

Pothead. That's where I'd been headed: the final, fatal role of the young would-be black man. Except the highs hadn't been about that, me trying to prove what a down brother I was. Not by then, anyway. I got high for just the opposite effect, something that could push questions of who I was out of my mind, something that memory. I had discovered that it didn't make any difference whether you smoked reefer in the white classmate's sparkling new van, or in the dorm room of some brother you'd met down at the gym, or on the beach with a couple of Hawaiian kids who had dropped out of school and now spent most of their time looking for an excuse to brawl. Nobody asked you whether your father was a fat-cat executive who cheated on his wife or some

THE NEW CROW JIM

laid-off joe who slapped you around whenever he bothered to come home. You might just be bored, or alone. Everybody was welcome into the dub of disaffection. And if the high didn't solve whatever it was that was getting you down, it could at least help you laugh at the world's ongoing folly and see through all the hypocrisy and bullshit and cheap moralism.

That's how it had seemed to me then, anyway. It had taken a couple of years before I saw how fates were beginning to play themselves out, the difference that color and money made after all, in who survived, how soft or hard the landing when you finally fell. Of course, either way, you needed some luck. That's what Pablo had lacked, mostly, not having his driver's license that day, a cop with nothing better to do than to check the trunk of his car. Or Bruce, not finding his way back from too many bad acid trips and winding up in a funny farm. Or Duke, not walking away from the car wreck ...

I had tried to explain some of this to my mother once, the role of luck in the world, the spin of the wheel. It was at the start of my senior year in high school; she was back in Hawaii, her field work completed, and one day she had marched into my room, wanting to know the details of Pablo's arrest. I had given her a reassuring smile and patted her hand and told her not to worry, I wouldn't do anything stupid. It was usually an effective tactic, another one of those tricks I had learned: People were satisfied so long as you were courteous and smiled and made no sudden moves. They were more than satisfied; young black man who didn't seem angry all the time.

Except my mother hadn't looked satisfied. She had just sat there, studying my eyes, her face as grim as a hearse. "Don't you think you're being a little casual about your future?" she said. "What do you mean?" "You know exactly what I mean. One of your friends was just arrested for drug possession. Your grades are slipping. You haven't even started on your college applications. Whenever I try to talk to you about it you act like I'm just this great big bother." Damn it, Bar, you can't just sit around like some good-time Charlie, waiting for luck to see you through." "A good-time what?" "A good-time Charlie. A loafer."¹¹

Obama said he never did smack because his smack connection was a repulsive sleaze bag. But what was he doing hanging around with the dude in the first place? And a lot of coke connections have been known to substitute heroin for coke to get their clients addicted. Interesting that he used the word "smack," somewhat esoteric drug slang. What other president ever used that word or aspired to be a drug dealer? This says something about the all-pervasiveness of the Black criminal subculture as does Obama's statement that he is worried about his daughters doing "stuff."

I thought about Malia and Sasha. They're wonderful girls, but they're teenagers. **They do some things.** And I remember me being a teenager --and I've written about this, I did **some stuff.** And I've been very honest about it. So what I think about is there but for the grace of God, and that's what we all have to remember. And when we do, then I think

11. <http://www.nytimes.com/2006/10/24/world/americas/24iht-dems.3272493.html>

THE NEW CROW JIM

we've got a chance to make a real change...Young people do stupid stuff and as they get older, they get a little less stupid. I speak from experience. That at least was my experience. And now I'm watching my teenage girls, and they're a lot smarter than me, but there are still some gaps in judgment...There are some communities we know that are more vulnerable, and the kids there are more vulnerable. And part of what I hope this discussion does is to remind us that just as it could be Malia or Sasha, or Cary's kids, or any of our kids.

"Stuff," as in *hard stuff*, is another word for dope "You got the stuff man?" Obama continued to reflect on the pivotal moment in his life when he decided against becoming a drug dealer:

And that's an important moment in my life although also a scary one cause then you start realizing that you have to figure out what you really do believe and what is important and who I really am.



Even though Obama never became a drug dealer per se, he flooded the United States with cheap heroin. The US Attorney

General Loretta Lynch presided over a US Attorney's office that cut heroin smugglers loose with probation or light sentences. The United States attorney's office in Brooklyn embraced an approach that allows heroin couriers to plead guilty and offer information in return for much shorter sentences.¹² The policy reflected the views of Holder and Lynch that the mandatory minimum sentences for drug-related offenses which require prison terms of five years and higher in these smuggling cases were too harsh on defendants who were allegedly nonviolent disadvantaged African Americans or Hispanics.

Since Holder and Lynch, both African-American, changes in drug sentencing have served to further lower punishments for these couriers. A year ago, drug couriers regularly faced three years in prison; now they might face guidelines starting at only a few months, or no prison time at all.

How much information get you squeeze out of a mule? At most who gave him the drugs to transport and where they were to be dropped off. So flood the country with heroin because the mules are underpaid poor African-Americans and Hispanics. As a result hard working African-American people get mugged, ripped off by junkie scum looking for an angry fix!

Because of Holder's policy, Staten Island, long a blue-collar bastion of police officers and other New York City workers, is confronting a heroin epidemic. Thirty-six people died from heroin overdoses in 2012, the highest number in at least a decade, according to the most recent available city health department records; the death rate was higher than the city's other four boroughs had seen in 10 years. The amount of heroin seized by the Police

12. http://www.nytimes.com/2014/07/14/nyregion/14courier.html?_r=0

THE NEW CROW JIM

Department on Staten Island has jumped more than 300 percent from 2011 to 2013.¹³ Holder, a Black supremacist, was spreading heroin addiction among Whites by making it more readily available. Interestingly enough Trump Over-Performed the Most in Counties with the Highest Drug, Alcohol and Suicide Mortality Rates

Donald Trump did better than Mitt Romney in 2,469 (79.5 percent) of the 3,106 counties included in these analyses. This includes 51 percent of large urban counties, 70 percent of small urban counties, 84 percent of micropolitan counties, and 92 percent of rural counties. Trump performed even better in the Industrial Midwest (88.5 percent of counties) and Appalachia (91 percent of counties). Even in New England, where Hillary Clinton won every state, Trump received a larger share of votes than Romney in 69 percent of counties.¹⁴

TABLE 1. PERCENTAGE OF COUNTIES WHERE TRUMP DID BETTER THAN ROMNEY, BY REGION

| | U.S. | Industrial Midwest | Appalachia | New England |
|--|------|--------------------|------------|-------------|
| Overall Percentage of Counties where Trump Did Better than Romney | 79.5 | 88.5 | 90.7 | 68.7 |
| Percentage of Counties with Above-Median Drug, Alcohol and Suicide Mortality Rate where Trump Did Better than Romney | 81.7 | 94.8 | 94.5 | 82.9 |
| Percentage of Counties with Below-Median Drug, Alcohol and Suicide Mortality Rate where Trump Did Better than Romney | 77.3 | 83.8 | 80.2 | 53.1 |

Data Sources: Atlas of U.S. Presidential Elections; U.S. Centers for Disease Control and Prevention

13. <http://www.nytimes.com/2014/05/05/nyregion/heroins-new-hometown-in-staten-island.html>

14. http://aese.psu.edu/directory/smm67/Election16.pdf?wpisrc=nl_daily202&wpm=1

Holder was the Black racist Father Flannigan (“no boy is bad if given a chance”) who believes there is no such thing as a bad Black boy if given a chance. This is because Holder believes criminals exist because of racism focused against his race that results in poverty; not because African-Americans have made the choice to develop a widespread criminal subculture. So in a major shift in criminal justice policy, Holder ordered prosecutors to omit listing quantities of illegal substances in indictments for drug cases, sidestepping federal laws that impose strict mandatory minimum sentences for drug-related offenses.



Former Attorney General Eric Holder instructed federal prosecutors across the country to charge fewer people with low-level, nonviolent drug crimes and instead focus on more serious, violent crime. In the first year after the program was implemented, the number of drug offenders charged under mandatory-minimum sentencing guidelines fell by 20 percent.¹⁵

Under a policy memorandum sent to all United States attorney offices prosecutors were told that they may not write the

15. <https://www.themarshallproject.org/2016/08/10/the-obama-criminal-justice-reforms-that-trump-could-undo#.qlizUeJ5e>

specific quantity of drugs when drafting indictments for drug defendants who meet the following four criteria: their conduct did not involve violence, the use of a weapon or sales to minors; they are not leaders of a criminal organization; they have no significant ties to large-scale gangs or cartels; and they have no significant criminal history. But these factors might be hidden and overlooked.¹⁶

In states that have undertaken prison and parole overhauls, the changes were approved by state lawmakers. Holder's reform was different: instead of going through Congress for legislation to modify mandatory minimum sentencing laws, he invoked his power of prosecutorial discretion to sidestep them. Obama claimed his administration was fighting the upsurge in crime "in the U.S. Attorney's Office where we're not telling prosecutors you're going to be promoted based on how many maximum sentences you get, but rather based on how wise your use of prosecutorial discretion."

Even though Holder was doing the right thing in this case, because minimum mandatory sentences for drugs often do more damage to the Black community than the drugs themselves, the problem here was that Holder was stealing the power of Congress to pass legislation and stealing the powers of the Judiciary concentrating this power in the Executive Branch. Even if the legislation was wrong and sponsored by the racist Newt Gingrich it none-the-less makes America less of a democracy and more an autocracy.

Obama moved to "ban the box" on federal job applications, prohibiting government agencies from preemptively asking prospective employees about their criminal history.

Where do most African-American heroin addicts get the

16. <http://www.nytimes.com/2013/08/12/us/justice-dept-seeks-to-curtail-stiff-drug-sentences.html>

money to support their habits? They get it from committing crimes rather than from trust funds. And who do the fiends by the dope from: members of the Black Criminal Subculture who are often at war with one another. The use of crack cocaine is widespread in every public housing project in the United States. PCP is popular in some segments on the Black community. Crack heads and dopers destroy lives, families, and neighborhoods and should be treated as scum; however Obama thinks they should be called “junkies” as this stigmatizes them. He has more sympathy for addicts than for their victims because at one time he was into the drug scene. Obama:

Now, one of the problems we have is too many families suffer in silence, feeling like they were the only ones struggling to help a loved one. And let’s face it, there’s still fear and shame and stigma that too often surrounds substance abuse -- and often prevents people from seeking the help that they deserve. Because when people loosely throw around words like “junkie,” nobody wants to be labeled in that here I think today is to replace those words with words like father, or daughter, or son, or friend, or sister. Because then you understand there is a human element behind this. This could happen to any of us in any of our families. What if we replaced a word like “junkie” with recovery coaches and specialists like Jordan?

This revisionist thought is a recurrent theme of the Black racists to give more latitude to pathological behavior or institutionalize it. If African-Americans can’t obey the drug laws, the drug laws must obey African-Americans.

THE NEW CROW JIM



The next step in decriminalization of crime has already arrived; Danielle Sered is the founder and director of Common Justice, which works with the Brooklyn, New York, District Attorney's office and crime victims to negotiate alternatives to prison for people ***who commit violent felonies***.

Common Justice also recognizes that prison reform on the whole, while deeply admirable, has yet to include energetic advocacy for those who commit violent offenses, and that efforts to enact significant change are often stymied by the lack of viable, safe, alternatives to incarceration—particularly for cases of violence.

We will not end mass incarceration without taking on the question of violence. We have a choice. We either give up the aspiration of ending mass incarceration or we steer into the question of what to do about people who commit harm. The other reason is that if you ask survivors of violent crime

what they're worried about, it's people who may hurt them. And many don't trust police to protect them. We know that fewer than half of victims of violence call the police in the first place when they're hurt.¹⁷

The idea that mass incarceration will not end without taking on the question of violence restated means we have to institutionalize the black criminal subculture and treat it humanly. She hints at this reference to gangs when she says victims will not be safe if a violent felon receives a long bid because other gang members will retaliate and the cops can't stake out everyone's crib that is in danger.

Sered says she doesn't take cases of rape or murder into her "program" in which the armed robber, attacker, wife beater, thug gets to meet his or her victim and receives a lecture on morality and right and wrong. Theoretically speaking, Danielle needs to be beaten to an inch of her life in order to knock some sense into her head.



17. <http://decarceration.org/2015/11/24/breaking-our-reliance-on-prison-to-address-violence/>

THE NEW CROW JIM

Another liberal solution - putting criminals on the pad: Four of Lonnie "Homeboy" Holmes' cousins had died in shootings. He was a passenger in a car involved in a drive-by shooting, and he was arrested for carrying a loaded gun. But when Holmes was released from prison last year, officials in Richmond, California, offered him money. They began paying Holmes as much as \$1,000 a month not to commit another gun crime. Richmond also hired ex-convicts to mentor dozens of its most violent offenders.

The mentors have coaxed inebriated teenagers threatening violence into city cars, not for a ride to jail but home to sleep it off — sometimes with loaded firearms still in their waistbands. The mentors have funded trips to South Africa, London and Mexico City for rival gang members in the hope that shared experiences and time away from the city streets would ease tensions and forge new connections. The Black Criminal Subculture is tolerated and institutionalized, just as this book says that it is.¹⁸

Federal authorities in Baltimore alleged that an employee of the city-funded violence intervention program Safe Streets has been leading a drug trafficking organization involved in "several" shootings. A complaint charging Terrell Allen, 43, with distribution and possession with intent to distribute drugs was unsealed in U.S. District Court in Baltimore, two days after his arrest. The federal Bureau of Alcohol, Tobacco, Firearms and Explosives allege Allen was overseeing a drug organization operating in the Latrobe Homes area. James Piper Bond, the president and CEO of the Living Classrooms Foundation, the runs Safe Streets, said Allen had been employed since 2013 and has been a valuable outreach worker.

18. https://www.washingtonpost.com/local/dc-politics/cities-have-begun-to-challenge-a-bedrock-of-american-justice-theyre-paying-criminals-not-to-kill/2016/03/26/f25a6b9c-e9fc-11e5-a6f3-21ccdbc5f74e_story.html?tid=hybrid_experimentrandom_1_na&utm_term=.42f4b7bda7cc

He said Allen is presumed innocent until proven guilty. "Here's a guy who had, and has, an opportunity to turn his life around, and he was doing great work as a violence prevention mediator," Bond said. He noted that employees are asked to cultivate relationships with high-risk individuals to help curb violence. "That's their job, and so it's a very challenging, stressful situation. He did great work recruiting thugs into his drug gang while pretending to help "rehabilitate" them."¹⁹

Then there are some American-Africans who take all this even one step further than "programs"- a black lawyer named Elie Mystal, argues that black jury members and their "white allies" must clog up the court system and refuse to convict defendants accused of committing crimes against white males as a form of protest against what he sees as police brutality against black Americans. "Black people lucky enough to get on a jury could use that power to acquit any person charged with a crime against white men and white male institutions."²⁰

19. <http://www.baltimoresun.com/news/maryland/crime/bs-md-ci-safe-streets-atf-charges-20170227-story.html>

20. http://dailycaller.com/2016/12/09/dont-punish-anyone-who-kills-assaults-or-robs-white-men-editorial-argues/?utm_campaign=atdailycaller&utm_source=Twitter&utm_medium=Social

CHAPTER THREE

THE COP KILLING LOBBY'S MINISTER LOUIS FARRAKHAN

NATION OF ISLAM BLACK MUSLIMS: HERETICS

Serve Allah, and join not any partners with Him." An-Nisa' 4: 36

Then woe to those who write the Book with their own hands, and then say: "This is from Allah," to traffic with it for a miserable price! Woe to them, for what their hands do write and for the gain they make thereby. Al-Baqarah 2: 79

THE WALLACE FARD MYSTERY

The Black Muslims believe: "Allah came to us from the Holy City, Mecca, Arabia, in 1930. He used the name **Wallace D. Fard**" yet the racial heritage of Wallace Fard is an enduring mystery. The FBI reported Fard *may* have been named Wallace Dodd and *may* have been born in New Zealand on February 26, 1891. His father *may* have been British and his mother *may* have been Polynesian. Dodd *may* have arrived in the United States in 1913 and settled briefly in Portland, Oregon. The FBI, which initiated an investigation of Fard in 1942 that was to last more than thirty years, could not substantiate or verify his name at birth, birth date, place of birth, port of entry, exit, or present whereabouts, despite exhaustive inquiries. There are even indications that bodies were exhumed in the search for Fard. After Wallace Fard settled in Detroit, a detective from the Detroit Police Department assigned to monitor Fard's activities collaborated with a college professor from the University of Michigan on an article concerning Fard's Voodoo Cult, also known as Allah's Temple of Islam.



After both of these men had died, the FBI questioned the detective's widow about Wallace Fard. She reported: "It was her recollection that this person was actually of Jewish origin and his real name was a Jewish name, unknown to her, but not similar to either Fard or Ford."²¹ There were unconfirmed reports that Wallace Fard visited synagogues in Detroit and that he took the name Fard from *Sephardic*. He was rumored to have been a dark-skinned Jew of middle-eastern origin.

On November 17, 1918 Wallace Fard was arrested for assault with a deadly weapon but was released. He moved to Los Angeles where he opened a speakeasy and was arrested for bootlegging in January 1926. Many other Jews were arrested for this offense during the Prohibition Era. His common-law wife in Los Angeles was white. When she gave birth to a boy, the child's birth certificate listed the child as a member of the white race. After he separated from his wife Fard never sent her money for the child's support. His wife told the FBI that the boy died on August 3, 1942 while in the Coast Guard. In June 1926 Wallace Fard was arrested under the California Poison Act for sale of cocaine.

21. FBI 100-33683-38

THE NEW CROW JIM

Fard's partner made a deal to sell the drug to an undercover police officer and told the officer that Fard had the drugs in his possession. The deal was concluded in Fard's speakeasy. Fard was sentenced to six months to six years in San Quentin Prison and was released in May 1929. In all of these arrests he was identified as white. His prison record listed him as white. The leader of the *black* Muslims was a *white* and possibly a Jew.

The prophet and founder of the cult made his first appearance among the Negroes of Detroit as a peddler. Like Jewish peddlers, he went from house to house selling his wares. In this way he could get into people's homes for every woman was eager to see the nice things he had. Fard began to comment on the diet of his customers and recommended they follow what was essentially a kosher regimen since it forbade the eating of pork. Fard learned of a Moorish Islamite group headed by Noble D. Ollie called Allah's Temple of Islam. The peddler suddenly assumed the role of a prophet and took over this group. He began to attack the teachings of the *New Testament* and his sermons became popular in the black community. He preached:

My name is W.D. Fard and I came from the holy city of Mecca. More about myself I will not tell you yet, for the time has not come yet. I am your Brother. You have not yet seen me in my royal robes. I am from the tribe of Koreish, the tribe from which the Mohammed the Prophet sprang. I am a Hashemite. I am the Supreme Ruler of the universe.

The Hashemite family tree is well documented and the name Fard is definitely not present. Eight thousand Negroes heard "the call." Most of them were recent illiterate migrants from the South who had been the victimized by white racism. Wallace Fard told them that their illiteracy was a result of Caucasian "trickology."

“Why does the devil keep our people illiterate? So he can use them as a tool and also as a slave.” The Negro migrants listened to him because they were discontent with life in the North. The Great Depression deprived them of their livelihood and many went on welfare, which was given to them begrudgingly by whites. The crowded quarters they were forced to live in and the cold climate added to their discontent. The Prophet proclaimed that his followers did not belong to America and their allegiance was to him, and to Allah. Fard organized a University of Islam. Truant officers tried to break up the University and a riot ensued.

A Japanese national, Major Satochasi Takahashi, who had been deported from the United States and then had re-entered illegally and married a Negro woman, preached at Fard’s gatherings. Takahashi was an agent of the racist Black Dragon Society of Japan. Wallace Fard predicted a race war between the darker people and the white people of the world. Fard told the Negroes not to serve in America’s armed forces. He was useful to the armed forces of Japan. Today, the United States Defense Department reported that there are approximately 9000 Muslims on active duty in the U.S. armed services (it is reported that more than 3000 Americans embraced Islam during the Gulf war alone). Many of these men are Black Muslims. Many of them refused to fight in the Gulf War. The Black Muslims, although not true followers of Allah, still remain extremely useful to the *Ummah* in carrying out our plan to destroy America by subverting its armed forces!

More serious difficulties arose from the question of human sacrifice than from draft dodging. Wallace Fard taught that it was the duty of every Muslim to offer to sacrifice four Caucasian devils in order that he might return to his home in Mecca and that Allah demanded obedience unto death from his followers. No Muslim dare refuse the sacrifice of himself or his loved one should Allah require it. On November 21, 1932 Robert Kariem erected an alter in his house and sacrificed his roomer, John J. Smith. He plunged a knife into Smith’s heart.

THE NEW CROW JIM

Wallace Fard was arrested on May 25, 1933. The official report stated Wallace Fard said that he had passed himself off as black and that his teachings were “strictly a racket” and he was “getting all the money out of it he could.” Making a deal with Fard, the police let him out of a psychiatric ward on condition he disband Allah’s Temple of Islam; Wallace Fard agreed, but then changed the name of his cult to the Nation of Islam. Wallace Fard subsequently left Detroit and visited his common-law wife in Los Angeles. He told her he had sold medical supplies since his release from San Quentin, was returning to New Zealand, and he gave her some long flowing white sheets that he said he no longer needed. There is no record that he ever returned to New Zealand. On September 26, 1933 Wallace Fard was arrested in Chicago for disorderly conduct. Before this arrest he had met Elijah Poole, while walking down a Detroit street. Elijah Poole changed his name to Elijah Mahammad and became Fard’s disciple. Elijah Mahammad had accompanied Fard to Chicago. Wallace Fard unaccountably vanished without a trace in Chicago in 1934. Looking back at the violent history of these heretics, this researcher believes Fard was murdered and his body disposed of, by his successor, Elijah Mahammad. Perhaps a clue to the fate of Fard lies in the actions of a close associate of Elijah Mahammad, Verlene Ali, who was arrested on January 1937 as he prepared for the ceremonial slaying and cooking of his wife and daughter.²² Wallace Fard probably met the same end and was cooked then served to his own disciples as Halal meat.

After assuming the leadership of the Nation of Islam by the alleged order of its deceased founder, Elijah Mahammad faced a death plot at the hands of a few disgruntled members of the group who believed he was behind Wallace Fard’s disappearance. Elijah Mahammad, while hiding out in Washington, D.C. was arrested on May 8, 1942, for evading the draft and telling others to do so.

22. FBI FOIA “Miscellaneous information about Wallace D. Fard, who is said to be the original founder of the Black Muslim movement.” <http://foia.fbi.gov/fard.htm>

Elijah Mahammad subsequently ran the Nation of Islam for 40 years, until his descent to hell in 1975. Elijah Mahammed claimed to have been in touch with Wallace Fard after his disappearance through mental telepathy.



Elijah Mahammad propagated Fard's heretical teachings: Blacks were the original race of men, but 6,000 years ago, a mad scientist named Yacub invented whites to be a curse upon the black man. The Qu'ran said nothing of this. Elijah Mahammad taught that the Holy Prophet was black. The Hadith²³ says: "He [the Prophet] uncovered his thigh and I saw the whiteness of the thigh of the Prophet."²⁴ " Whenever the Prophet used to offer prayer he used to keep his arms away (from his body) so that the whiteness of his armpits was visible."²⁵ In *Message to the Black Man* published in 1965 Elijah Mahammad wrote: "You will agree with me that the whole Caucasian race is a race of devils." The Black Muslim religion calls all whites devils, and claims that Muhammad was black. Since Muhammad was white, the Black Muslim religion either lies, or the one it claims to follow is a devil. Elijah Mahammad put himself on equal footing with the Prophet

23. Compilations of Muhammad's teachings written down after the completion of the Qu'ran some of which are considered authoritative by Islam – the true Hadith – other are considered false.

24. Bukhari 1:367 (p.224)

25. Bukhari 1:771, (p.430). Bukhari 2:140, 141 (p.77, 78) are both similar. See also Bukhari 1:63 and 2:122.

THE NEW CROW JIM

I am the first man since the death of Yakub (4,000 years ago) commissioned by God directly. I say no more than Jesus said. He said that He came from God. I say that I am 'missioned by God'...Orthodox Islam must bow to Black Islam (God's choice). Arabs misunderstand the Holy Qur'an when they don't accept me [Elijah Muhammad] as a prophet. Six thousand years ago the black race gave birth to Allah, He is the mightiest God since creation, born after Yakub. Twenty-four scientists wrote the Bible and Qu'ran - one scientist was appointed to be God. Moses used dynamite with a fuse to kill 300 of his followers.

This is Islamic heresy, pure and simple, and is punished by death.

FARRAKHAN TAKES OVER

After Elijah's death in 1975 his son Wallace D. Mohammed took over the Nation of Islam. He denounced black supremacy and many of his father's apostate beliefs, and like Malcolm, embraced traditional Islam. Louis Farrakhan led a breakaway movement that sought to maintain the Muslim heresy such as: "Bombs from spaceships circling the earth created the mountains." Like Wallace Fard, Louis Farrakhan also believes in spaceships. He claims Elijah Muhammad is living on one that is circling the planet and a few years after Elijah "died," the spaceship picked up Farrakhan and the two men had a chat with each other. Afterward, Farrakhan says the spaceship let him off near Washington, D.C.

One would think that this moron would be rejected by African-Americans with any sense but just as the Reconstruction Era gave birth to the Ku Klux Klan the New Reconstruction Era has given birth to a Black version of the Ku Klux Klan.

Remember the largest Black KKK racial supremacist march in American history was *The Million Man March* in October 1995. It was attended by 400,000 Black men and sponsored by Louis Farrakhan a cheap hustler and a violent Black apostate “Islamic”²⁶ cult leader. The *Million Man March* far outnumbered the 50,000 Ku Klux Klans’ 1924 march.



THE MILLION MAN MARCH

26. “Islamic” appears in quotation marks because by claiming the founder of the Nation of Islam, Elijah Mohammad, was part of a continuation in the line of Prophets Farrakhan is committing major shirk, or sin, in Sunni Islam. In the Qur’an Mohammad said: "The chain of messengers and prophets has come to an end. There shall be neither messenger nor prophet after me!"



1924 KKK MARCH

Farrakhan (**Louis Eugene Walcott**) organized a 20th anniversary sequel to *The Million Man March*, entitled *Justice or Else*, which was poorly attended because the African-Americans have a Black racist in the White House. Black Lives Matter, the New Black Panthers and other members of the Cop Killing Lobby were there. These groups and others are convinced that despite the sacrifices made by Americans during the Civil War, despite the deaths of Civil Rights workers during the early 1960's, and despite Civil Rights Legislation America remains an evil nation that must be destroyed. This is what Farrakhan said in a November 2014 speech to an audience of African-American college students at Morgan State University in Baltimore, Maryland.²⁷

In the day of Moses and Aron and Joshua, see they were not afraid to take on the giants. These young people in Jefferson, they are not afraid of no tanks. Ferguson, yeah. What did I say?

27. <https://www.youtube.com/watch?v=97Y9FjtQ5Wc>

I guess that's where the governor is sendin' them tanks from, he's in Jefferson City isn't he, the capitol city yes yes those young people that are out there marching you never seen nothing like that. We get angry and in one week it's over but for over hundred men women children marching. But here's what got the whole country upset. See young people, social media is a great thing. But the enemy got you with the social media. "I'm on Facebook and I have 500 followers." I'm imitating you.

And what are you saying on Facebook? Well I'm telling you if it was me you understand in fact if they come down with the wrong decision here is what I am going to do and you and your five hundred friends agree the National Security Agency of the United States Government got you but the talk about what is about to go down is all over the country and **that is why the President had to speak out** because they expect an explosion. Now these young people they have been made for the Messiah. They are not made for no apologist leaders. Mr. Crump, the lawyer, Attorney Crump, he is a good brother and in the name of the mom and the dad he is telling the youth peaceful protests regardless of what they say we are going to be peaceful and White folks gather preachers and politicians and educators for god sake tell the students that whatever comes down we'll accept it we will protest, we will protest but we must be peaceful. **But the young they are God's children and they are not going down being peaceful. Listen. Listen. Watch. Watch now. Because once it starts it's on. You may not wanna fight but you better get ready. Teach your baby how to throw the bottle if**

they can't bite. We gonna die anyway; let's die for something. Elijah Muhammad said forty years ago, maybe near 50 years ago there were 20 million of us then he said if 10 million lost our lives 10 million would be left to go free.

Now wait, wait wait. Just think about that. My Muslim family here Imams and my Christian family. In this book there is a law for retaliation. Like for like the Bible says an eye a tooth a life. ***See now as long as they kill us and go to Wendy's and have a burger and go to sleep they gonna keep killing us but when we die and they die then soon we are going to sit at a table and talk about reparations we want some of this earth or will tear this goddamn country up.***

Farrakhan repeated his cop killing edict at Mt. Zion Missionary Baptist Church in Miami and received a round of applause from the audience:

The Quran teaches persecution is worse than slaughter. Then it says, 'Retaliation is prescribed in matters of the slain.' Retaliation is a prescription from God, to calm the breast of those whose children have been slain. ***So if the federal government will not intercede in our affairs, then we must rise up and kill those who kill us. Stalk them and kill them and let them feel the pain of death that we are feeling.***

In August 2015 Farrakhan told an audience at a Milwaukee Wisconsin church:

I wouldn't bring our young women and young men into some place to be slaughtered. But that's what the White man hopes for. That's why he makes

mischief with my words. ***'Farrakhan wanna get an army to kill people,' because, you see, White people deserve to die.*** And they know so and they think it's us coming to do it. No, no, no.

Farrakhan later said in the video that a God will send a UFO, "a chariot" or "wheel in the sky," to rescue his followers and carry out justice if a race war began which is what the Black Nazi Farrakhan hopes for just as George Lincoln Rockwell of the American Nazi Party did.



ROCKWELL ATTENDS NATION OF ISLAM MEETING

Farrakhan is part of the violent wing of *The Cop Killing Lobby*. At the *Justice or Else March* Farrakhan will be calling for the formation of a Black version of the KKK. The Apostate Imam wants to organize lynch mobs and death squads to carry out extra-judicial execution of law enforcement officers and Whites. He will be encouraging Black youth to commit arson, loot and riot unless every White police officer who kills a Black criminal, armed or unarmed, in self defense or not in self defense is sent to prison, guilty or not guilty.

THE NEW CROW JIM

The *Justice or Else! March* is really a good old fashion necktie party: reverting back to the law of the jungle by circumventing the judicial process. It is vigilantism whether it is carried out by Whites or Blacks.

Until the New Reconstruction Era lynching has traditionally been viewed as Whites doing the lynching and Blacks being lynched. Between the Civil War, Reconstruction and World War II, thousands of African Americans were lynched in the United States. Lynchings were violent and public acts of torture that frightened Black people throughout the country and were largely tolerated by state and federal officials. It was terrorism carried out in public not dissimilar to ISIS beheadings.

Now Farrakhan is calling for the lynching of police officers and like the crimes of Southern Whites once were; his activities are largely tolerated by state and federal officials. Gene Ryan, president of the Fraternal Order of Police of Baltimore, Maryland, had this to say about the arson and looting that went down thanks to the death of a heroin dealer named Freddie Gray.

The images seen on television look and sound much like *a lynch mob* in that they are calling for the immediate imprisonment of these officers without them ever receiving the due process that is the Constitutional right of every citizen, including law enforcement officers.

As stated it was Louis Farrakhan who led the Million Man March, the largest racist demonstration in American history Black or White. The Jewish Defense Organization led the fight against Farrakhan on campuses throughout America and Canada.

In an interview with CNN's Don Lemon Farrakhan recounted the hostile atmosphere in the mid-80s when groups such as the Jewish Defense Organization protested at venues where Farrakhan was scheduled to speak, saying: "Who do you want? Farrakhan! How do you want him? Dead!" "How should I respond to that?" Farrakhan then asked. "Well, I'm a warrior [and] you can bring that out of me right now if you go the wrong way with me. I'm still a warrior; I'm a warrior for truth and I'm a warrior for justice."²⁸



28.

http://www.finalcall.com/artman/publish/National_News_2/Minister_Farrakhan_s_interview_with_CNN_anchor_Don_3410.shtml

THE NEW CROW JIM





The Nation of Islam preys on ignorance with stories that only intellectually challenged people would believe. Farrakhan claimed to have visited Elijah Muhammad in a flying saucer.²⁹ In this article Farrakhan's scientists claim that *Doctors Without Borders* deliberately spread Ebola:



29.

http://www.finalcall.com/artman/publish/Perspectives_1/article_8786.shtml

“There is no natural disease called Ebola,” according to Dr. Abdul Alim Muhammad, minister of health and human services for the Nation of Islam. He called Ebola a “weaponized virus” rooted in chemical pharmaceutical company, to conduct and biological weapons research by Germany in the 1930’s and perfected in the United States.³⁰

It is a weapon that can be used to depopulate, weaken and dominate nations, he said. There are “stories of the U.S. Department of Defense funding Ebola trials on humans, trials which started just weeks before the Ebola outbreak in Guinea and Sierra Leone. The reports states that the DoD gave a contract worth \$140 million dollars to Tekmira, a Canadian Ebola research.

“This research work involved injecting and infusing healthy humans with the deadly Ebola virus,” this according to Dr. Cyril Broderick, a professor of plant pathology at Delaware State University and a Liberian national. His thoughts were contained in a piece published in an online edition of *The Daily Observer*, a newspaper in Monrovia.³¹

“The U.S. government has a viral fever bio-terrorism research lab in Kenema, a town at the epicentre of the Ebola outbreak in West Africa,” he added. Dr. Broderick listed research into Ebola and similar viruses conducted in West Africa, and Liberia, by the

30.

http://www.finalcall.com/artman/publish/National_News_2/article_101807.shtml

31. <http://www.liberianobserver.com/>

A. J. WEBERMAN

U.S. Army Medical Research Institute of Infectious Diseases, “a well-known centre for bio-war research, located at Fort Detrick, Maryland;” Tulane University through the National Institutes of Health; the Centers for Disease Control; **Doctors Without Borders**; UK-based GlaxoSmithKline; and the Kenema Government Hospital in Kenema, Sierra Leone.

Dr. Broderick added,



It is most disturbing that the U.S. government has been operating a viral hemorrhagic fever bioterrorism research laboratory in Sierra Leone. Are there others? Wherever they exist, it is time to terminate them. If any other sites exist, it is advisable to follow the delayed but essential step: Sierra Leone closed the U.S. bioweapons lab and stopped Tulane University for further testing.”

According to Dr. Abdul Alim Muhammad, the Ebola virus comes out of the Defense Dept. bio-weapons program in Fort Detrick, Md., during the 1970s. The late leader of Zaire, Mobutu Sese Seko, was approached by a U.S. contractor with the

THE NEW CROW JIM

Department of Defense associated with biological weapons research at Fort Detrick, said Dr. Muhammad. *The company was contracted to field test the HIV virus and needed a population of people to conduct the tests on, he continued.*

They chose Eastern Zaire at the time, but President Mobutu refused the plan, he said. “In retaliation they released a virus that later became known as Ebola” in a village near the Ebola River that had a 90 percent mortality rate, charged Dr. Muhammad. That was 1976 and the first occurrence of Ebola—in what was then Zaire—now the Democratic Republic of the Congo, he said. “Since then every outbreak of Ebola had been a deliberate act of bio-warfare against a population,” said Dr. Muhammad.

According to the Nation of Islam, AIDS and EBOLA was part of a biological warfare program. All of the deaths attributed to these diseases are the result of a country as evil as Nazi Germany because it is bent on genocide. No responsibility on the part of the African governments who let it get out of control but these Obama voters blame the outbreak on ***Doctors Without Borders*** the very people who are risking their lives to fight this disease. And the President of the United States is connected to this delusional thought through Sharpton and Wright.

Like his brothers in the Nation of Islam, Obama has little faith in Western Medicine. When high levels of lead were found in the water of Flint, Michigan, Obama traveled there to assure the residents that the water was safe, however, he never really drank it.



NOTE HOW THE LEVEL OF THE WATER REMAINS CONSTANT

CHAPTER FOUR

THE EMPOWERMENT OF THE BLACK CRIMINAL SUBCULTURE



If we put racism in the United States into historical perspective we will find that America is at the vanguard in the fight against it: The United States paid a bloody price to rid itself of slavery, a form of racism second only to the Nazi death camps. Nearly as many men died in captivity during the Civil War as were killed in the whole of the Vietnam War. Hundreds of thousands died of disease. Roughly 2% of the population, an estimated 620,000 men, lost their lives in the line of duty. Take that into account the next time you hear someone call America a racist country.

The Confederacy was defeated however the racist culture of South persisted. Reconstruction, one of the most turbulent and controversial eras in American history, began during the Civil War and ended in 1877 was supposed to transform Southern culture.

But just as the assassination of John F. Kennedy had a profound effect on the war in Vietnam the assassination of President Lincoln had a profound effect on Reconstruction. Both assassinations put a conservative Southern Democrat in power that was on the ticket to balance it out. And both were named Johnson.

As a result of John Wilkes Booth and his co-conspirators, Reconstruction of the Union was easier than convincing Southerners to accept Blacks as citizens especially with a racist like Andrew Johnson as president. The military occupation of the South by the federal government, the imposition of martial law and the threat of suspension of habeas corpus continued after Andrew Johnson assumed power however Johnson did little to prevent the creation of the Black Codes that reinstated slavery:

Every civil officer shall, and every person may, arrest and carry back to his or her legal employer any freedman, free Negro, or mulatto who shall have quit the service of his or her employer before the expiration of his or her term of service without good cause; and said officer and person shall be entitled to receive for arresting and carrying back every deserting employee aforesaid the sum of five dollars, and ten cents per mile from the place of arrest to the place of delivery; and the same shall be paid by the employer, and held as a set-off for so much against the wages of said deserting employee...³²

Reconstruction is widely regarded as an era of corruption and misgovernment in which many Whites used this period to their economic and political advantage. The carpetbaggers and

32. <http://www.Blackpast.org/primary/1866-mississippi-Black-codes#sthash.8yYA6zUb.dpuf>

THE NEW CROW JIM

sallywags exploited the post-war South. This political chaos helped to justify the South's system of Jim Crow, racial segregation and denying the vote to Blacks.

Reconstruction was America's first failed experiment in interracial democracy. Now, thanks largely to the Obama Administration, we are experiencing a New Reconstruction Era where everything is upside down and African-American hip-hop culture and Black racism is slowly being substituted for traditional American values and White racism. The state, local and federal laws are being modified or selectively enforced to conform to African-American misbehavior.

Why? Many Democrats believe that Blacks have no choice in life but to be criminals, so crime becomes a form of political protest against the status quo, even an entitlement, in what is perceived as a society where the cards are stacked against the African-American. Ergo Black criminals are no longer considered "criminals" by Black politicians if they riot and attack White police because they are oppressed by poverty and racism. Looting and arson have become accepted by Blacks as a form of legitimate political protest and therefore looters and arsonists should not be shot or arrested. Many Black politicians and community leaders should wear a campaign button that reads "Vote For Me And I Will Decriminalize Crime!"

Case in point: a former Dane County assistant district attorney who serves as the University of Wisconsin-Madison's director of community relations said that shoplifters at "big box" retailers should not be prosecuted. "I just don't think that they should be prosecuting cases for people who steal from Walmart."



THOU SHALT STEAL

Reverend Everett D. Mitchell once stated “I’ll be honest I think what gets in my way sometimes is my own fear and that I don’t trust White people. I don’t trust White women and actually I’m afraid. I was telling one of my friends the other day that. I won’t even allow myself to be in the same office with a White woman without the door open where somebody can see me.” Not a particular White woman but all White women. This man is nothing but a Black racist and his ideas are helping to formulate the New Black Codes of the New Reconstruction Era.

Black supremacists want their approximation to English that’s filled with scatology, references to incest, abbreviations, and bad grammar to be accepted as the King’s English. A group of students staged a “sit-in” in Professor Val Rust’s dissertation course offered by the UCLA Graduate School of Education in an attempt to highlight Professor Rust’s racially underpinned “microaggressions” toward blacks. Rust had the audacity to correct their papers in the traditional fashion. Among the 81-year old professor emeritus’s alleged transgressions are repeatedly requiring students to write

“Indigenous” in lowercase form instead of uppercase form (consistent, by the way, with its not having proper noun status as can be discovered readily in any standard dictionary), requiring students to capitalize “white” if they also choose to capitalize “black.”

Obama firmly believes White racism is entirely to blame for the state of Black America, and that Blacks bear little if any personal responsibility for it therefore he looks at gangbangers as victims. He’s more interested in helping them than he is in helping the real victims. Obama spoke at the Emmanuel African Methodist Episcopal church in Charlestown, South Carolina after a Nazi scum named Dylann Roof killed 9 African-Americans holding a bible study group. Obama:

Perhaps it causes us to examine what we’re doing to cause some of our children to hate. Perhaps it **softens hearts** towards those **lost young men**, tens and tens of thousands caught up in the **criminal justice system** -- and leads us to make sure that that system is not **infected with bias**.³³

Because Roof, a Nazi maggot, committed a heinous act for which he deserves to “ride the lightning” we’re supposed re-evaluate our attitude toward the “tens and tens of thousands” of Black criminals or are not evil but “lost young men?” What has one thing have to do with the other? The only connection I can think of is that both Roof and the “lost young men” murder Blacks.

It is July 6, 2015. A seven year old boy was killed in Chicago because his father had a beef with another gang. The father who has 40 arrests is refusing to co-operate with the police. Is the Black who did this another “lost young man?” Is the father another “lost

33. <https://www.Whitehouse.gov/the-press-office/2015/06/26/remarks-president-eulogy-honorable-reverend-clementa-pinckney>

young man?" There are more than "tens and tens of thousands" of incarcerated "lost young men" it is more like millions of **lost young men**. Have these "lost young men" been singled out by the police and the courts, not because they are amoral criminals, but because of their race?

According to Obama millions of Black men have been framed by racist cops, juries and judges and a Black Criminal Subculture is not responsible for the high rates of incarceration. There **are** prisoners who have been framed by a corrupt judicial system but not millions of them. According to Obama gangsters, crack and heroin addicts and dealers, murderers, armed robbers, rapists, burglars, muggers, thieves are just children of clay who have no choice but to commit an inordinate amount of violent crime, destroy other people's lives and, thank god, periodically off each other. Obama:

And without making any excuses for criminal activities that take place in these communities, what we also know is that if you have impoverished communities that have been stripped away of opportunity, ***where children are born into abject poverty;*** they've got parents -- often because of ***substance-abuse problems or incarceration*** or lack of education themselves -- can't do right by their kids; if it's more likely that those kids end up in jail or dead, than they go to college. In communities where there are no fathers who can provide guidance to young men; communities where there's no investment, and manufacturing has been stripped away; and drugs have flooded the community, and the drug industry ends up being the primary employer for a whole lot of folks -- in those environments, ***if we think that we're just going to***

send the police to do the dirty work of containing the problems that arise there without as a nation and as a society saying what can we do to change those communities, to help lift up those communities and give those kids opportunity, then we're not going to solve this problem. And we'll go through the same cycles of periodic conflicts between the police and communities and the occasional riots in the streets, and everybody will feign concern until it goes away, and then we go about our business as usual.³⁴

“And without making any excuses for criminal activities that take place in these communities.” That is exactly what Obama is doing in this speech. There are children in other countries that are born into far worse “abject poverty” yet do not become thugs. United State’s poverty rate (less than \$18,552 for a family of three; less than \$23,834 for a family of four) is 27.2% but among children in single parent families of two: 40.8 percent (2013).³⁵ This mindset is responsible for the fact that when Seattle police officers write use of force reports they no longer allowed call a suspect a suspect. “Community member” is the new term. Several officers say the term is offensive, explaining their work with violent suspects.³⁶

African-American polygamous culture is partially responsible for African- American poverty. What are White people and Jews supposed to do about children not having fathers? Propose to the baby-moms?

34. <https://www.Whitehouse.gov/the-press-office/2015/04/28/remarks-president-obama-and-prime-minister-abe-japan-joint-press-conference>

35. <http://www.spotlightonpoverty.org/exclusivecommentary.aspx?id=93e821a0-46b1-4562-b499-e8646300e8bf>

36. <http://www.kiro7.com/news/local/community-member-term-for-suspects-on-seattle-police-use-of-force-reports/521033548>

According to Obama “substance-abuse problems or incarceration” of the parents of thugs are partially to blame. So I assume the grandparents of thugs were to blame for the fathers of thugs being thugs and the great grandparents were to blame for the grandparent’s being thugs. Where does the buck stop and moral responsibility begin?

“Drugs have flooded the community, and the drug industry ends up being the primary employer for a whole lot of folks -- in those environments, if we think that we're just going to send the police to do the dirty work of containing the problems that arise there.” Dirty work: dishonest, unethical, or criminal acts. “He always sends his henchmen to do his dirty work rather than doing it himself.” There is a cop hating President in the White House.

This gang warfare is fueled by the demand for drugs and the wealth it generates but it is also a form of atavistic tribal warfare. It is governed by the law of the jungle. The police are faced with throwbacks to savagery, psychopaths with no regard for human life for they themselves have not developed a sense of humanity. Later on in life they might start understanding right from wrong but with mass long term incarceration it may be too late.

Meanwhile the *Cop Killing Lobby* scrutinizes the cops every action blaming police brutality for the creation of the Black Criminal Subculture. They do this from afar, as most of the leaders of the *Cop Killing Lobby* live in affluent, lily-White neighborhoods. What created this violent subculture? Discrimination? Wage slavery? All-pervasive deterministic forces? Cultural influences such as rap? Absolutely! To end or diminish a problem you have to understand its causes.

But no matter how you account for it there is no denying that there is a Black criminal “gangsta” subculture in the New

THE NEW CROW JIM

Reconstruction Era and that it is growing day by day. As a result there are a vast number of African-Americans involved in criminal activity. This subculture is the reason there are so many African-Americans locked up, on parole, bail, probation, in most cases not because African-Americans are unfairly targeted by police.

The Black Criminal Subculture is an indigenous entity with its own language, dress, music and moirés. You can only become a member of if you are African-American. In some gangs you have to commit a crime to prove you are not an undercover cop. Sometimes it is just a random attack on a defenseless person. Nothing but savagery. If one gang member is arrested the ones on the outside will intimidate or murder witnesses. This is what makes gangs so dangerous. This world moves to the angry drumbeat of hip hop lyrics where cops are pigs, woman are ho's or bitches, gays are faggots and the idea of life is to deal, pimp, steal from dope dealers, kill other rap artists and accumulate bling.

Making Notorious B.I.G. into a national hero is symptomatic of this regression. On March 9, 1997 Biggie was gunned down by rival crack dealers at age 24 in Los Angeles in a still-unsolved murder. Some say it was relation against he hit he put out on Murderer-ghetto-hero Tupac Shakur, whose mother Assata Olugbala Shakur, is fugitive cop killer living in Cuba. Brooklyn Democratic Rep. Hakeem Jeffries recited some of Notorious B.I.G. lyrics on the floor of Congress.

It was all a dream,
I used to read Word Up! Magazine
Salt-n-Pepa and Heavy D up in the limousine
Hangin' pictures on my wall
Every Saturday Rap Attack, Mr. Magic, Marley Marl,

Jeffries, who is the nephew of CUNY professor **Leonard Jeffries, Jr.**^[34] a notorious black racist turd, paid tribute to the overgrown thug; “Biggie Smalls the king of New York. He died 20 years ago today in a tragedy that occurred in Los Angeles. But his words live on forever. I got the privilege of representing the district where Biggie Smalls was raised. We know he went from negative to positive and emerged as one of the world most important hip hop stars. His rags-to-riches life story is the classic embodiment of the American dream. Biggie Smalls is gone but he will never be forgotten. Rest in peace Notorious B.I.G.. Where Brooklyn at?” Jeffries worked in the litigation department of Paul, Weiss, Rifkind, Wharton & Garrison as did former Homeland Security Director Jeh Johnson. This law firm has long term ties with Communists. He is also tied in with the Ratner family, financiers of the Cop Killing Lobby.

This is a world where dress style proclaims: “I’m a gangbanger and I might as well get used to not wearing a belt ‘cause the motherfuckers ain’t gonna let me wear one in the joint.” Obama wants the police to ignore signs in the way people dress that indicate they are part of the Black Criminal Subculture.

And there are hardworking, wonderful families and kids who -- they want to be safe. They want to be in partnership with the police. They just want to make sure that a police officer is properly trained so that just because a kid has a hoodie, they have -- partly because they know the community, they don’t automatically assume, well, that must be somebody I should arrest or frisk, and I can distinguish between kids the same way we -- in their own neighborhood they can distinguish between kids who are really causing trouble and kids who are just being kids. So I think the moment is here, but we’ve got to build on it and we’ve got to be systematic about it.

THE NEW CROW JIM

This is a world of polygamy as was practiced in Africa, a world of baby moms rather than wives. Obama Father's Day 2008 Speech:

We know that more than half of all Black children live in single parent households, a number that has doubled since we were children. Any fool can have a child. That doesn't make you a father. It's the courage to raise a child that makes you a father.³⁷

This is a subculture that begins with the breakdown of one family. Among African-Americans, nearly 5 million children, or 54 percent, live with only their mother.³⁸ Other more reliable sources put the figure at 67%.³⁹

The male child perceives this as the standard Black lifestyle and adopts it in his lifestyle as will his children. It is self perpetuating. Black kids with no dads or several part time dads turn to older gang members as role models or join gangs as means of protection for themselves and their "moms."

This is a world fueled by a craving for drugs. From 1980 to 2007 about one in three of the 25.4 million Adults arrested for drugs was African American.⁴⁰ Obama can relate to drug dealing gangsters because he admitted he considered becoming one

37. https://www.washingtonpost.com/opinions/colbert-king-when-fatherless-young-offenders-are-fathers-themselves/2012/12/21/cd833920-4b85-11e2-a6a6-aabac85e8036_story.html

38. <http://www.washingtontimes.com/news/2012/dec/25/fathers-disappear-from-households-across-america/?page=all>

39. <http://datacenter.kidscount.org/data/tables/107-children-in-single-parent-families-by#detailed/1/any/false/36,868,867,133,38/10,168,9,12,1,13,185/432,431>

40. <http://www.southerncoalition.org/mass-incarceration-people-color/>

himself and so he wants to ensure that these young Black lost souls have an even chance when it comes to attacking or killing cops.

Obama has more sympathy for the perpetrators of crime than for their victims and so he wanted to level the playfield between gangbangers and cops. Obama:

That we embrace changes in how we train and equip our police so that the ***bonds of trust*** between law enforcement and the communities they serve make us all safer and more secure.⁴¹

Obama wants to build “Bonds of trust?” between demonstrators and police. According to Obama the “no snitching, no testifying” rule in the ghetto is a result of distrust in the police and court system. It is not the result of an atavistic tribal *us against them* mentality or fear of retribution from gang members still on the outside who will come after anyone who testifies against another gang member. For example a series of incidents in Baltimore helped to shake confidence in the criminal justice system. In 2002, seven members of the Dawson family were killed in a retaliatory firebombing of their East Baltimore home, and three years later the home of a North Baltimore community activist who was reporting drug activity to police was firebombed.

A DVD titled "Stop Snitching"⁴² released around that time featuring an appearance by NBA star Carmelo Anthony threatened violence against those who cooperate with authorities. But according to the Cop Killer Lobbyist Obama it is because the police haven't established bonds of trust that accounts for the lack of witness cooperation. During the New Reconstruction Era everything

41. <https://www.Whitehouse.gov/the-press-office/2015/06/26/remarks-president-eulogy-honorable-reverend-clementa-pinckney>

42. <https://www.youtube.com/watch?v=cnaoVV46hk4>

THE NEW CROW JIM

gets blamed on White cops and discrimination! Obama said this at the Clementa Pinckney eulogy:

Maybe we now realize the way racial bias can infect us even when we don't realize it, so that we're guarding against not just racial slurs, but we're also guarding against the subtle impulse to ***call Johnny back for a job interview but not Jamal.***

Just as during Reconstruction where Whites were hired over Blacks simply because of race, Obama wants Blacks to be hired over Whites because of race during the New Reconstruction Era. But maybe Jamal is less qualified for the job having dropped out of school? Maybe Jamal has a criminal record and some of his gangbanging friends might convince him to help pull off an inside job? Maybe Jamal will come to work high or drunk? Maybe Jamal is litigious and will sue if he is not promoted or is fired? Maybe he will return and kill those he held responsible for his being terminated? Case in point a gay Black racist named Vester Flanagan who wanted to start a race war with Whites. Flanagan killed two reporters and wounded a woman who was being interviewed then killed himself.

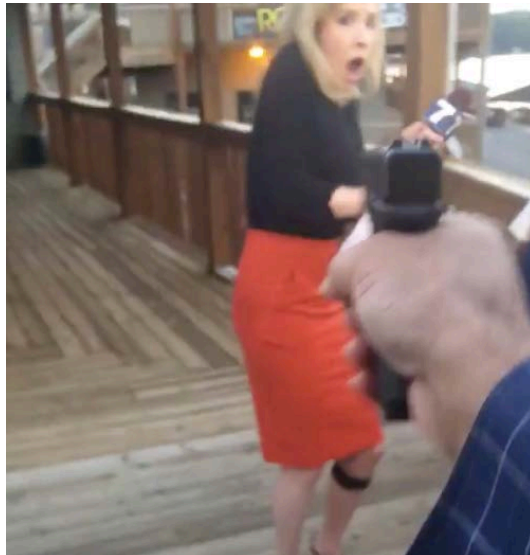

There were signs that Vester was a classical disgruntled employee.

Monica then presented Vester Flanagan with his separation agreement which she explained would provide two weeks of severance pay and earned PTO. He became agitated instantaneously and said he would need at least three months of severance. He repeated his feeling that firing him would lead to negative consequences for me personally and for the station.

He indicated he'd recorded our previous conversations and pulled up what appeared to be a small felt bag from his lap, but did not produce a recording device. I told Bryce he could clean out his desk now or we'd make arrangements to do it tomorrow, when fewer people are in the newsroom.

I honestly don't know if I was able to finish this point, when Bryce said he had to go to the bathroom, stood up abruptly, stormed out of the room, and slammed the door. This caused members of the sales team to take shelter in a locked office.

Monica immediately called 911 and we waited at the front desk for the police to arrive. We asked Dave Seidel to escort him to the newsroom and supervise the gathering of his personal belongings. When two Roanoke Police Officers arrived, Bryce had gone back into the newsroom. When we got there he had just gotten off the phone with a friend or family member. Right before this he called the front desk seeking Todd Schurz' phone number. The officers instructed Bryce not to make any further phone calls and he

THE NEW CROW JIM

needed to leave the premises immediately. Bryce continued dialing Todd's assistant and obviously got through to her and said the following: "This is Bryce Williams at WDBJ in Roanoke and I have an emergency and need to speak with Todd immediately."

I believe the officers again asked him to end his call and allow them to escort him from the newsroom. He told the officers about a watermelon that was sitting in the hallway and that was akin to someone calling him a nigger.

When the officers again tried to calm him down and tried to physically lift him from his chair he said, "Don't touch me, you're hurting my shoulder." The officers managed to get Bryce to his feet at which time he picked up a ball cap and threw it at me. One of the officers immediately asked if I wanted to press assault charges and I responded, "Not at the moment."

Vester had race constantly on his mind. When someone invited him to "swing by for lunch" he thought it was a reference to Blacks being primates swinging from tree to tree. If a White woman held a pencil during an argument with him he believed it could have been used as a weapon. If someone had watermelon at the station he believed this harkened by to Black kids sitting on a fence eating it.

Vester is an extreme example of hiring on the basis of race, which I assume that TV Station did. How extreme remains to be seen as ABC news has refused to release his manifesto in full. ABC turned over a copy to FBI so I filed and FOIA suit for it. The FBI responded that it is classified due to a perspective or ongoing investigation of the incident.

Obama's *Cop Killing Lobby* agenda involves demilitarizing local police forces: so he cut off certain types of military surplus equipment that they obtained from the Defense Department even though the gangbangers are armed with automatic weapons. Obama issued an executive order calling for additional oversight of various federal programs which provide military surplus equipment to local law enforcement agencies. He banned grenade launchers, bayonets, tracked armored vehicles, weaponized aircraft and vehicles, firearms and ammunition of .50-caliber or higher. This equipment will no longer be provided to state and local police agencies by the federal government under Obama's order.

We've seen how militarized gear can sometimes give people a feeling like there's an occupying force, as opposed to a force that's part of the community that's protecting them and serving them. It can alienate and intimidate local residents and send the wrong message.

Obama is more worried about the perceived feelings of the looters and arsonists and shooters than he is about protecting the police and citizenry. He leveled the playing field between the cops and the rioters and gangbangers. Just as Whites disarmed freed Blacks during Reconstruction Obama is disarming Whites during *The New Reconstruction Period*.

THE NEW CROW JIM



This is from the report Holder commissioned on Ferguson:

The deployment of the armored vehicles contributed to many in the community perceiving the police presence as a military-type response. It was clear the armored vehicles stirred the emotions of demonstrators—they expressed fear, anger and intimidation by the vehicles' mere presence.

Community members stated that the vehicles were “acts of aggression” by the police. One community member said, “The tanks looked like the police were invading.” Another stated that the vehicles were “embarrassing and an incredible overreaction by the police.” And another citizen stated, “To see a tank riding down West Florissant was heartbreaking; it was heartbreaking that they had to respond to us that way.”

My heart goes out to the poor offended rioters. The police should deploy convertibles if that will make them feel better. Of course the rioters are going to object to armored vehicles. It makes their job of rioting, looting and burning much harder because it makes it harder to attack the police.



FIGURE 16

In Ferguson, one highly controversial tactic borrowed from the military was the use of “overwatch,” a technique intended to provide a layer of security for officers and citizens by having a sniper monitor armed threats from a higher position that provides the sniper a better view.

Based on interviews with the St. Louis County PD, the department stated that this was used in mass gatherings as an active-shooter defense tactic, not a crowd control tactic, when there was gunfire or armed persons. Essentially, as used in Ferguson, when there was gunfire in the crowd, a police sniper would take a position on top of a tactical vehicle and use the rifle sight to monitor the crowd, looking for the armed person (see figure 16). The St. Louis Metropolitan PD and the Missouri State Highway Patrol did not use the overwatch tactic. While this tactic may be appropriate to protect officer and citizen lives in certain situations, such as an active shooter threat, it is ineffective and inappropriate for crowd control.

THE NEW CROW JIM

By deploying this tactic so visibly, law enforcement helped to further the sentiment that they were reacting in a militaristic manner. From the perspective of those who were protesting peacefully, a police officer was pointing a sniper rifle at the crowd—a particularly alarming behavior, especially if the rifle is pointed at the viewer.⁴³

The Justice Department would rather have cops take a bullet than offend the demonstrators by taking counter-measures. The pendulum has swung in the other direction and Black Rioters Lives have become more important than police.

In an interview with Marc Maron Obama continued to blame White America for the lack of progress made by Blacks:

I always tell young people in particular: Do not say that nothing's changed when it comes to race in America unless you've lived through being a Black man in the 1950s, or 1960s, or 1970s. It is incontrovertible that race relations have improved significantly during my lifetime and yours, and that opportunities have opened up, and that attitudes have changed. That is a fact. What is also true is that the legacy of slavery, Jim Crow, discrimination, in almost every institution of our lives, that casts a long shadow, ***and that's still part of our DNA that's passed on.***

Obama is a Black racist and essentially a eugenicist who believes the African gene is superior to the European because it free of the racism DNA strand.

43. <http://ric-zai-inc.com/Publications/cops-p317-pub.pdf>

If a White politician brought DNA into the equation he would be labeled a racist. Obama continued:

We're not cured of racism. We are not cured of it. Clearly. ***It's not just a matter of it not being polite to say nigger in public.*** That's not the measure of whether racism still exists or not. It's not just a matter of overt discrimination. ***Societies don't overnight completely erase everything that happened two to three hundred years prior.*** So what I tried to describe in the Selma speech that I gave, commemorating the march there, was, again, a notion that progress is real, and we have to take hope from that progress. But what is also real is that the march isn't over, and the work is not yet completed. And then our job is to try in very concrete ways to figure out, what more can we do?

It is common knowledge that "niggers" are allowed to use the word nigger and Whites are not. So by using the N word Obama is telling us that he is a "nigger" even though he is half White. An important indication that Black racism exists is the constant use of the word "nigger" a racially charged word, by African-Americans. Every word is "nigger" this and "nigger" that. This means Blacks constantly have race on their minds like an obsessive thought. You don't hear Jews saying "Mike hey my kike" or Whites "He my honkie."

America is an overtly racist country according to its American-hating president. "Societies don't overnight completely erase everything that happened two to three hundred years prior." Three hundred years is not exactly overnight, it is a long time ago. So, according to Obama, during the New Reconstruction Era we should go after those whose ancestors trace back to slavery and

THE NEW CROW JIM

collectively punish them for the sins of their forefathers. The reality is America has come a long way from the 1866 Mississippi Black Codes:

That it shall not be lawful for any freedman, free negro, or mulatto to intermarry with any White person; nor for any White person to intermarry with any freedman, free negro, or mulatto; and any person who shall so intermarry, shall be deemed guilty of felony, and on conviction thereof shall be confined in the State penitentiary for life.

Obama continued:

And then our job is to try in very concrete ways to figure out, what more can we do? So let's take the example of police practices. Cops have a really tough job. And part of the reason cops have a tough job, particularly in big cities, is that there are communities that are poor, are systematically locked out of opportunity, that suffer from legacies of discrimination that have been built up over generations, ***and we send cops in there basically to say, keep those folks from making too much trouble.***

According to America's first cop-hating President, the police are an occupying force in the Black community. This is straight Black Panther rhetoric. Black Panther leader Bobby Seale:

Come on out, Black people. Come on out and get to know about these racist dog swine who been controlling our community and occupying our community like a foreign troop. Come on out and we're going to show you about swine pigs.

Huey Newton Obama and H. Rapp Holder say, RIGHT ON BOBBY, OFF THE PIGS!

The point is though that we can break it down to these component parts and say that number one there are specific ways we can make police community relations better and police more accountable. And so we put together a task force with police officers and young people ***including some of the folks who led the Ferguson marches*** and surprisingly they came up with a consensus of things that could be done that would make things better. Alright so let's implement those. Now In the meantime what are we doing to help those lowest income communities?

We need to know that early childhood education works. That is one way to break the legacy of racism and poverty if a three year old, four year old kid is in an environment of love and is getting a good meal and has a teacher that is trained in early childhood development and is hearing enough words and is being engaged enough they can get to where a middle class kid is pretty quickly. The problem is that it happens spottily. It happens in this community or this school district, or this neighborhood or this outstanding principal is making something happen, or this philanthropist has decided to do something. So what hasn't happened is us making a collective commitment.

The Justice Department found that Officer Darren Wilson was justified in shooting Michael Brown and the "hands up" story was a lie none-the-less Obama legitimized it by forcing the police to meet with protesters or possibly rioters. Early childhood development is a great idea but in the end the child will have to return to his or hers baby mom and no father will be there to

enforce discipline. Early childhood education is definitely worth a try but gangster peer pressure can negate it and if there are no living wages jobs available it is worthless. Obama:

The point I'm making is when you look at how to deal with racism, how to deal with issues of *some* of the police shootings that have been involved, *I'm less interested in having an ideological conversation than I am looking at what has worked in the past* and applying it, and scaling up. What is required is a sense on the part of all of us that what happens to those kids matters to me, even if I never meet them, because my society is going to be better off, I'm going to feel better about the America I live in, and over time I'm confident that my children and my grandchildren are going to live a better life if those kids also have opportunity.

Obama was careful to say *some* of the police shootings, not all of them because the Justice Department investigation concluded the shooting of Michael Brown was justified. What would be included in Obama's ideological conversation? Rhetoric! Obama doesn't want to recite the anti-police ideology of the Black community and he would rather go back to the past for a solution: He goes into a monologue about kids after he says this so I assume he wants a stronger Black family and an end to the polygamous baby mom syndrome.

That's where we have to feel hopeful, rather than to say that *nothing has changed*, we have to say, "Wow, we've actually made significant progress over the last fifty years." If we made as much progress over the next 10 years as we have over the last 50, things would be better.

Initially Obama says we have made significant progress but goes on to say it is insignificant. Things should have move five times faster when it comes to making African-Americans progress. Change has been so slow that nothing has really changed. The Whites are still a bunch of racist crackers.

And that's within our grasp, it's available to us. And this is where, again, you want to get to those decent, well-meaning Americans who would agree with that, but when it gets translated into politics it gets all confused. And trying to bridge that gap between the good impulses of the overwhelming majority of Americans and how our politics expresses itself continues to be the biggest challenge.

According to Obama the only decent, well meaning people are the Democrats. The Republicans are racist scum and express this in their politics.

Jeff Sessions told a gathering of police officers that Trump had reversed all of this:

One sheriff told me earlier this year about how, due to the prior administration's restrictions, the federal government made his department return an armored vehicle that can change the dynamics of an active shooter situation. These are the types of helmets and gear that stopped a bullet and saved the

THE NEW CROW JIM

life of an officer during the Orlando nightclub shooting. This is the type of equipment officers needed when they pursued and ultimately killed terrorists in San Bernardino. Studies have shown this equipment reduces crime rates, reduces the number of assaults against police officers, and reduces the number of complaints against police officers. Those restrictions went too far. We will not put superficial concerns above public safety. All you need to do is turn on a tv right now to see that for Houstonians this isn't about appearances, it's about getting the job done and getting everyone to safety. The executive order the President will sign today will ensure that you can get the lifesaving gear that you need to do your job and send a strong message that we will not allow criminal activity, violence, and lawlessness to become the new normal.

Top Tweet earned 18.3K impressions

las vegas shooting **#Obama** **#ATF** made **#bumpstocks** legal to even the odds between **#police** and **#BlackCriminals**
#LasVegasShooting **#Trump**
pic.twitter.com/GD47sSviAA



↩ 11 ↻ 76 ❤ 75

CHAPTER FIVE

OBAMA'S PLAN TO DISARM AMERICA

Obama's plan to empower the Black Criminal Subculture involved disarming legal gun owners so they will be at the mercy of Black criminals. Obama's Clementa Pinckney eulogy:

I hope we also see the ***30 precious lives cut short by gun violence in this country every single day***; the countless more whose lives are forever changed -- the survivors crippled, the children traumatized and fearful every day as they walk to school, the husband who will never feel his ***wife's warm touch***, the entire communities whose grief overflows every time they have to watch what happened to them happen to some other place. ***The vast majority of Americans -- the majority of gun owners -- want to do something about this.***

Obama gives a long tear jerking rap on Black and Black crime then segues to legal gun owners? Are legal gun owners responsible for the civilian casualties' when rival drug gangs take care of business? Who is responsible for the husband who will never feel his wife's warm touch? Obama has the chutzpah to imply that it's some of the NRA members doing the capping in the inner cities, it's the evil violent pig nose Whites with their underwear neatly tucked in their pants that are doing all the killin'. Blacks have no personal responsibility what-so-ever for the shootings that, under the Obama administration, are increasing in frequency.

According to Obama "the *vast majority of Americans and the majority of gun owners*" -- want to do something about this. What he is implying here is that the vast majority of Americans who don't own guns should support legislation taking the guns away

from the majority, not the vast majority, but the majority (which translates to minority) who do own guns?

Legal gun owners are not Black gangsters and thugs. They are people attempting to protect themselves from gangsters and thugs, hunters and target shooters. Obama blames them for Black crime when in reality the violence in the Black community that rages on and on is not the NRA's fault; it is the fault of the African-American Criminal Subculture and its misuse of freedom.

Nobody wants to live in a crime ridden neighborhood and there is a correlation between a Black majority neighborhood and crime. In an article on the low crime rate in Watts, California, which was once the location a hotbed of crime the *New York Times* reported: "While the area remains persistently poor, demographics have transformed it from an African-American enclave to a neighborhood that is more than 70 percent Latino." That is the reason crime has decreased. Less people who are prone to commit crime:

Today is Saturday June 27, 2015. I searched for the word "homicide" in *Google News*. The first entry did not name a suspect, the second was a White woman, and the third were two Blacks. The next article was about a spike in the number of homicides in Washington, D.C. with 30 people killed since May 1, 2015.⁴⁴ The majority of the victims were Black with the exception of the slaying of three members of the Savopoulos family and their housekeeper allegedly by a Black.

The perpetrators in the vast majority of these crimes were also Blacks. The next entry was "Oklahoma City police identify 4

44. http://www.washingtonpost.com/local/crime/dc-homicides-jump-20-percent-amid-a-surge-in-may-june/2015/06/25/2effd93c-1b37-11e5-93b7-5eddc056ad8a_story.html

men wanted in connection with homicide.”⁴⁵ All four were Black. The next was in Columbus, Ohio where Tyrone Hilton was capped.⁴⁶ The next article concerned a White who was killed in Fort Pierce, Florida.

This researcher didn't cherry pick these articles, *Google* chose them. The statistics are unbelievable: Chicago just went through another violent July 4th, 2015 weekend with shootings killing 10 people and wounding another 54.⁴⁷ Everyone sees this but to say anything other than that it was caused because of poverty and discrimination and not because of a Black Criminal Subculture is racist. Racism also plays a part on the gun supply end of the equation. It is the gun store owners and salespeople in the South that allow straw purchases that are partly to blame. They figure the weapon will be used to kill another Black so they look the other way when evidence points to straw purchase of multiple weapons.



45. <http://www.news9.com/story/29420193/police-identify-four-suspects-wanted-for-nw-okc-home-invasion-murder>

46. <http://www.10tv.com/content/stories/2014/05/18/columbus-home-invasion-robbery-residents-on-edge.html>

47. <http://www.chicagotribune.com/news/local/breaking/ct-chicago-violence-20150706-story.html>

THE NEW CROW JIM

Badger Guns in Milwaukee allowed Julius Burton (photo above) to come into the store with an adult, pick out a gun while standing alongside the adult and then it allowed the adult to purchase the weapon. The gun was used to blind a policeman in one eye and inflict brain damage on another. The officers took Badger guns to federal court and sued them, winning a judgment against the Badger Corporation which is largely unenforceable.

Gun owners whose weapons are stolen during burglaries because they are not properly secured are contributing to the problem. But ultimately the craving for hard drugs and the Black Criminal Subculture it spawned are the culprits.

Obama expressed his desire to confiscate long arms in a podcast entitled *What the Fuck*.⁴⁸ By appearing on a podcast with that name Obama demeaned the American presidency. He demonstrated he wanted to introduce the word “fuck” into everyday speech and degrade the English language.

Television ads for Hyundai cars already contain beeped out obscenity such as “we have the best (beep) in’ deals.” Everyone knows to substitute the word “fuckin.” Next “motherfucker” will be deemed acceptable and English will become Ebonized. Not only is Marc Maron, the host of *What the Fuck*, vulgar, he is a 911 revisionist and believes the American government was behind the jihadist raid. Maron stated:

I honor the 911 truthers. This administration was complicit if not outwardly guilty in the attacks on 911 in my own view.

48. http://www.wtfpod.com/podcast/episodes/episode_613_-_president_barack_obama

Maron, a poor excuse for a Jew since 911 Revisionism is the first step in blaming the event on Jews or Israel⁴⁹ was a long time heroin addict. When you shoot smack the receptors in your brain are activated and you are never the same. "Marc the schmeker"⁵⁰ is a better name for the man Obama chose to interview him.

Obama stated:

Well look they have captured the suspect [Dylann Roof]. We've got a legal system that is going to work ***I think*** the way it is supposed to. People are paying a lot of attention to it.

According to Obama, the perpetrator, Dylann Roof, might walk if people didn't pay attention to his fate? Obama distrusts America because he believes due to slavery and Jim Crow; Blacks are blameless for criminal acts.

The point I made in the immediate aftermath of the killing was that I've done this way too often during the course of my presidency; it feels as if a couple of times a year I end up having to speak to the country and to speak to a particular community about a devastating loss and you know the grieving that the country feels is real, the sympathy obviously, the prioritizing, comforting the families, all that's important. But I think part of the point I wanted to make was that it's not enough just to feel bad. There are actions that could be taken to make events like

49. <https://www.scribd.com/doc/38755860/9-11-Revisionists-exposed>

50. Jewish junkie

this less likely. ***And one of those actions we could take would be to enhance some basic common sense gun safety laws that, by the way, the majority of gun owners support.*** This is unique to our country. There is no other advanced nation on earth that tolerates multiple shootings on a regular basis and considers it normal and to some degree that's what's happened in this country; it has become something we expect. It's a crazy person you can't help it. But the truth of the matter is this doesn't happen with this kind of frequency in other countries. When **Australia** had a mass killing, I think it was in Tasmania about 25 years ago, it was just so shocking to the system the entire country said **we're gonna completely change our guns laws** and they did and it hasn't happened since. Well in fact typically right after Newtown happened for example gun sales shot up and ammunition gun shot up and each time that these events occur ironically the gun manufactures make out like bandits partly because of this fear that is churned up that the federal government and the Black helicopters are all coming to get your guns. Part of my argument is that it is important for folks to understand how hunting and sportsmanship around firearms is really important to a lot of people and it's part of how they grew up, part of the bonding they had with their dad and it evokes all kinds of memories and traditions and you have to be respectful of that. The question is there a way of accommodating that legitimate set of traditions with some common sense stuff what prevents a 21 year old who is angry about something or confused about something or is racist or is deranged from going into a gun store and suddenly is packin' and can do

enormous harm. And that is not something we have ever fully come to terms with and unfortunately the grip of the NRA on congress is extremely strong. I don't foresee any legislative action being taken in this congress. I don't foresee any real action being taken until the American public feels a sufficient sense of urgency and they say to themselves this is not normal; this is something we can change and we can change it. And if you don't have that kind of voter and voter pressure then it is not going to change from the inside.

Obama gives us the example of Australia implying that America should completely change its gun laws. Australia's gun control regime was first passed in 1996 in response to a massacre in Tasmania that left 35 dead.⁵¹ The law banned semiautomatic and automatic rifles and shotguns. It also instituted a mandatory buy-back program for newly banned weapons.

Then Obama contradicts himself by laughing at those who believe he is a gun grabber and equating them with those that believe in the myth of Black helicopters. He goes on to promote hunting and sportsmanship but if it was up to him hunters would be using bows and arrows. Obama continued to tell Maron:

Right after Sandy Hook, Newtown, when 20 six year olds are gunned down and congress literally does nothing yeah that's the closest I came to feeling disgusted. I was pretty disgusted. But that is the exception rather than the rule. In the sense that on most fronts I have been able to find ways to make progress even in the face of obstruction, even in the face of resistance, even in the face of gridlock. So on climate change for example Congress has not acted

51. <http://www.cnn.com/2015/06/19/world/us-australia-gun-control/>

THE NEW CROW JIM

on the other hand just through rule-making we have been able to double fuel efficiency standards on cars we are right in the middle of putting together a rule to reduce carbon pollution from power plants and we'll get that stuff done. It would be a lot of more helpful if we had some cooperation from congress.

The Southern reaction to the Reconstruction Period was a concerted effort among local southern governments to disarm Freedmen. Radical Republicans attempted to intercede with new laws based on 2nd amendment protections, but Northern indifference to the plight of former slaves made this politically futile. Unconstitutional firearm restrictions in the reconstruction south ensured that the subjugation of Freedmen would continue. Now under the New Reconstruction, Obama is trying his best to disarm Whites. Obama:

But let's be clear: At some point, we as a country will have to reckon with the fact that this type of mass violence does not happen *in other advanced countries*. It doesn't happen in other places with this kind of frequency. And it is in our power to do something about it. I say that recognizing the politics in this town foreclose a lot of those avenues right now. But it would be wrong for us not to acknowledge it. And at some point it's going to be important for the American people to come to grips with it, and for us to be able to shift how we think about the issue of gun violence collectively.

What does Obama mean by "advanced?" He means White European countries. But it happened in Denmark when Anders Behring Breivik killed over eighty people. Two gunmen entered the office of a satirical magazine in France with an assortment of guns

and murdered 11 people (and injured 11 more). After leaving, they killed a police officer. And in a marketplace catering to Jews another five were murdered and 11 wounded.

There is no way to take away the unregistered guns belonging to criminals without doing a house to house search of every person in America. It is too late in the game. By making it more difficult for law abiding citizens to own weapons Obama is empowering the Black thugs whose cause he often champions along with the terrorists he harbors a hidden or subconscious sympathy for.

CHAPTER SIX

FREDDIE GRAY BLACK LIVES MATTER MARTYR

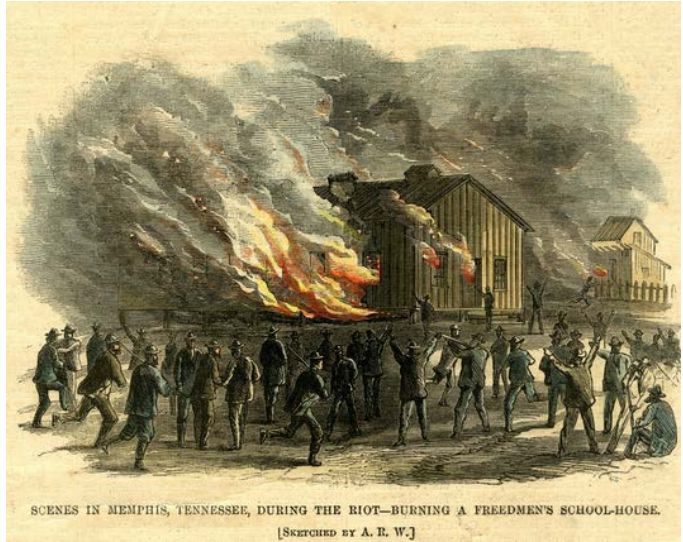

SCENES IN MEMPHIS, TENNESSEE, DURING THE RIOT—BURNING A FREEDMEN'S SCHOOL-HOUSE.
[SKETCHED BY A. R. W.]

During Reconstruction Race riots took place five times in Philadelphia (1832-49); in Cincinnati, where over half the Black inhabitants were driven out of town (1829); and sporadically in New York City, in 1866 in Memphis (May) and New Orleans (July).

When President Barak Obama called the arsonists, rioters and looters who destroyed a Black neighborhood in Baltimore a bunch of “thugs” rather than the usual misguided youth he was implying that a race riot had occurred.

There’s no excuse for the kind of violence that we saw yesterday. It is counterproductive. When individuals get crowbars and start prying open doors to loot, they’re not protesting, they’re not making a statement -- they’re stealing. When they burn down a building, they’re committing arson. And they’re destroying and undermining businesses and opportunities in their own communities that rob jobs and opportunity from people in that area.

So it is entirely appropriate that the mayor of Baltimore, who I spoke to yesterday, and the governor, who I spoke to yesterday, work to stop that kind of senseless violence and destruction. That is not a protest. That is not a statement. Its people -- a handful of people taking advantage of a situation for their own purposes, and they need to be treated as criminals.

Obama made this statement during a joint press conference with the Prime Minister of Japan, a country with a very small number of African-Americans. That is why it sounds so strong. However, it was Obama’s and Holder’s policies that fomented this race riot. Obama says he asked the Mayor of Baltimore to put an end to this type of violence and destruction however the Mayor later stated that she gave the rioters “space” in which to riot. This researcher was surprised she didn’t say “peacefully riot.” Obama continued:

THE NEW CROW JIM

The violence that happened yesterday distracted from the fact that you had seen multiple days of peaceful protests that were focused on entirely **legitimate concerns** of these communities in Baltimore, led by clergy and community leaders. And they were constructive and they were thoughtful, and frankly, didn't get that much attention. And **one burning building will be looped on television over and over and over again, and the thousands of demonstrators who did it the right way I think have been lost in the discussion.**

There were many more building burned than the one CVS and why minimize this even if there was only one? Obama is now taking the blame off the thugs and putting it on the media. The legal protests should have gotten more attention than the rioting? Which attracts an audience more – people carrying signs or people looting and burning? Judging from the photographs of the riot almost the entire Black community participated in it so it was in fact a race riot. Obama continued:

The overwhelming majority of the community in Baltimore I think have handled this appropriately, expressing real concern and outrage over the **possibility** that our laws were not applied evenly in the case of Mr. Gray and that accountability needs to exist. And I think we have to give them credit. My understanding is, is you've got some of the same organizers now going back into these communities to try to clean up in the aftermath of **a handful of criminals and thugs who tore up the place.**

If it is only "possible" that our laws were not applied evenly so why not wait to find out if they were, rather than peacefully protesting on the assumption they were not applied evenly and Freddie had been singled out only because he was Black?

What constitutes a “handful?” It is defined as a very small number. The criminals were a handful alright, a handful to the Baltimore Police and National Guard. Why criminals **and** thugs? Where there thugs who were not criminals and criminals who were not thugs rioting? Thug is the dog whistle term for “nigger.” So now we know what, in Obama’s opinion, constitutes a “nigger.” It is an African-American that riots. Baltimore City Councilman Carl Stokes protested Obama use of the word “thugs.”

Of course it's not the right word, to call our children 'thugs,' these are children who have been set aside, marginalized, who have not been engaged by us. No, we don't have to call them thugs. Just call them niggers.

Baltimore Mayor Stephanie Rawlings-Blake also called the rioters “thugs” however she later tweeted:

I wanted to clarify my comments on *thugs*. When you speak out of frustration and anger, one can say things in a way that you don't mean. That night we saw *misguided young people* who need to be held accountable, but who also need support. And my comments then didn't convey that.

According to this type of reasoning the thugs and gangbangers who sacked Baltimore were similar to the juvenile delinquents of the 1950's, but instead of zip guns they have glocks and incendiary devices. The arsonists who burned down a Baltimore senior home and community center weren't evil, just “misguided.”

The 60-unit affordable housing project sponsored by the Southern Baptist Church reportedly cost \$16 million and was due to

be completed in December 2015.⁵² Maybe some of the gangbangers grandmothers could have been placed there; but Mayor Rawlings-Blake, apologist for evil, allowed her misguided juvenile delinquents to torch this structure. How many older Blacks could have had their lives extended in this facility if the police had fired on the perpetrators. Rawlings is trading the lives of good Blacks for those of the bad. Rawlings-Blake:

It's a very delicate balancing act because while we try to make sure that they were protected from the cars and the other things that were going on, ***we also gave those who wished to destroy space to do that as well***, and we work very hard to keep that balance and to put ourselves in the best position to de-escalate.⁵³

The idea of crime as a legitimate political expression first originated with Black Panther Eldridge Cleaver in 1965. In his autobiography, *Soul on Ice* he wrote:

Rape was an insurrectionary act. It delighted me that I was defying and trampling upon the White man's law, upon his system of values, and that I was defiling his women. I felt I was getting revenge. From the site of the act of rape, consternation spread outwardly in concentric circles. I wanted to send waves of consternation though out the White race.

What are the results of following the political ideology of Eldridge Cleaver instead of the traditional morality of Beaver Cleaver?

52. <http://baltimore.cbslocal.com/2015/04/27/huge-fires-swallow-downtown-baltimore-buildings-shortly-after-riots>

53. <http://baltimore.cbslocal.com/2015/04/25/baltimore-mayor-gave-those-who-wished-to-destroy-space-to-do-that/>

Again, let me report on that is happening around me. On a weekend in late June 2015 9 Blacks were killed Philadelphia and 10 in Detroit. Detroit beat Philly 10 to 9. In 30 days, 39 people were killed in Baltimore, part of a wave of shootings that began after the death of death drug pusher and low life dope fiend Freddie Gray.



NO JUSTICE NO PEACE!

Freddie Gray was the kind of Afro-American who destroys an entire community by dealing dope. Gray did a four year bid for sale of crack and was a low level street dealer with a record for urinating in public, gaming/cards, dice, etc. and for malicious destruction of property. In August 2007 he was arrested for manufacture and distribution of narcotics. In December 2014 he was arrested for narcotics. In January 2015 he was arrested for burglary. Freddie Gray's step-father was Richard Shipley. Freddie Gray was a co-defendant in a gun case involving Michael Shipley who lived at the same address as Freddie.

His twin sister, born a few minutes later than him at midnight, also had a criminal record for auto-theft and other offenses. Entering the legal system is a rite of passage.⁵⁴

54. <http://casesearch.courts.state.md.us/casesearch/>

THE NEW CROW JIM

On March 20, 2015 Gray was out on bail for a smack charge so naturally he went back to his usual spot on North Avenue and Mount Street to deal some dope and raise money for his attorney's fees and for his heroin habit.

Gray tested positive for opiates at the Maryland Shock Trauma Center. On April 12, 2015 Freddie was arrested for possession of a switchblade knife after running away from his spot. No drugs were found in his possession. Freddie's other arrests had made no mention of concealed weapons.

In her indictment of the Baltimore PD officers who arrested the slimy heroin dealer Baltimore State's Attorney Marilyn Mosby claimed it was an illegal arrest when in reality it was not under a Supreme Court ruling captioned *Terry v. Ohio*.

On October 31, 1963 a Cleveland Police detective noticed three Black men acting suspiciously and pacing in front of a jewelry store. Concerned the men were "casing a job, a stick up" and were carrying weapons, the officer identified himself and asked them their names. The officer frisked them and found a pistol in John Wesley Terry's⁵⁵ overcoat pocket, and a revolver in Richard Chilton's coat pocket. Terry was found guilty and in June 1968, the United States Supreme Court affirmed the conviction and set a precedent that allows police officers to

55. In 1990 John Wesley Terry, 43, of Charleston, West Virginia, was arrested on a charge of breaking into a pharmacy and held in the Wayne County Jail on \$25,000 bond. John Wesley Terry was convicted June, 1993 in Seattle of sexual misconduct, third degree; however the rich Jewish lawyers of the ACLU had fought to put him back on the street after his first arrest in 1963 because of a "technicality."

interrogate and frisk suspicious individuals without probable cause for an arrest, providing that the officer can articulate a reasonable basis for the stop and frisk.

Former Baltimore police Detective Joshua Rosenblatt, division chief of Mosby's Crime Strategies Unit, wrote this in a March 17, 2015 email to a Western District police commander:

In early April the State's Attorney Mosby asked me to look into community concerns regarding drug dealing in the area of **North Ave and Mount St.**⁵⁶

Mosby stated:

On April 12, 2015 between 8:45 and 9:15 a.m., near the corner of **North Avenue and Mount Street**. Lt. Rice of the Baltimore Police Department while on bike patrol with Officer Garrett Miller and Edward Nero made eye contact with Freddie Carlos Gray Jr. Having made eye contact with Mr. Gray, Mr. Gray subsequently ran from Lt. Rice. Lt. Rice then dispatched over departmental radio that he was involved in a foot pursuit at which time bike patrol officers and Nero began to pursue Mr. Gray. Having come in contact with pursuing officers, Mr. Gray surrendered to Officers Miller and Nero in the vicinity in the 1700 block of Presbury Street.⁵⁷

Mosby had ordered Rosenblatt, who liaised with the police, to “round up the usual suspects” as in the movie Casablanca.

56. <http://www.baltimoresun.com/news/maryland/crime/blog/bs-md-ci-mosby-email-20150609-story.html#page=1>

57. <http://www.nydailynews.com/news/crime/criminal-charges-filed-freddie-gray-death-transcript-article-1.2206744>

FREDDIE GRAY: SPICE OR SELF INFLICTED INJURIES?

It is this researcher's conclusion Freddie was going to injure himself and blame it on the cops but he went too far and croaked himself or aside from natural marijuana which remains in the blood stream for a month he was high on spike that day. Labels on Spice or Spike products often claim that they contain "natural" psycho-active material taken from a variety of plants. Spice products do contain dried plant material, but chemical analyses show that their active ingredients are synthetic designer cannabinoid compounds.

The *Baltimore Sun* reported: "Gray tested positive for opiates and cannabinoid when he was admitted to Maryland Shock Trauma Center, according to the autopsy. The report makes no further reference to the drugs found in his system."⁵⁸ The report stated "Admission toxicological testing was positive for the presence of opiates and cannabinoid in the urine." Synthetic marijuana does not show up in a standard urine test. Was he tested for The *New York Times* reported:

Heather Drake, a 29-year-old paramedic, responded to a call at an apartment complex on the west side. When she arrived, four firefighters were grappling with a 120-pound woman who was flailing and flinging vomit at anyone who came near her. A bystander shouted that the woman was high on spike the local term for synthetic marijuana, which is more commonly known around the country as spice.⁵⁹

58. <http://www.baltimoresun.com/news/maryland/freddie-gray/bs-md-ci-freddie-gray-autopsy-20150623-story.html#page=1>

59. <http://www.nytimes.com/2015/07/12/magazine/spike-nation.html>

Freddie Gray told the cops that he couldn't breathe when they were carting him away. Spice users have reported: "I kept thinking there is no way something could make u feel like that. It made my whole body vibrate, felt like my heart stopped, and I couldn't breathe." "At one point my body felt so out of sync that I couldn't match my breathing with the amount of oxygen I needed." "I myself have also had a few trippy moments. I have had times where I couldn't breathe, my heart was racing and I was dizzy."

However you cut it Freddie Gray got what he wanted in the long run: Revenge on the cops who constantly arrested him and revenge on society.

Freddie had been in that police van numerous times before his ill fated ride. Why was his last time different than those that preceded it? A prisoner, Donta Allen, 22, sharing a police transport van with Freddie Gray told investigators that he could hear Gray "banging against the walls" of the vehicle and believed that he "was intentionally trying to injure himself," according to a police document obtained by *The Washington Post*. The prisoner was separated from Gray by a metal partition and could not see him. His statement is contained in an application for a search warrant, which is sealed by the court but slipped out anyway:

During transport Allen advised investigators that he could hear Gray banging against the walls of the wagon compartment. It was Allen's belief that Gray was intentionally trying to injure himself. Upon arrival to the Western District Police Station (1034 Mount Street) Gray was described as being unresponsive in the back of the wagon. A Medic was requested and Medic #43 responded to transport Mr. Gray to Shock Trauma where he eventually died on 04/19/15 at 05:59 am.

It is interesting to note that Donta made his "injuring himself during transport" statement before the Freddie Gray accidental suicide became a national matter. Later Donta changed his story and said that the cops misquoted him and it was a very faint banging sound. It was alleged he made up a story to work off a beef with cops however judging from Freddie Gray's long *nolle prosequi* criminal record Donta would have walked no matter what he said.

THE NEW CROW JIM

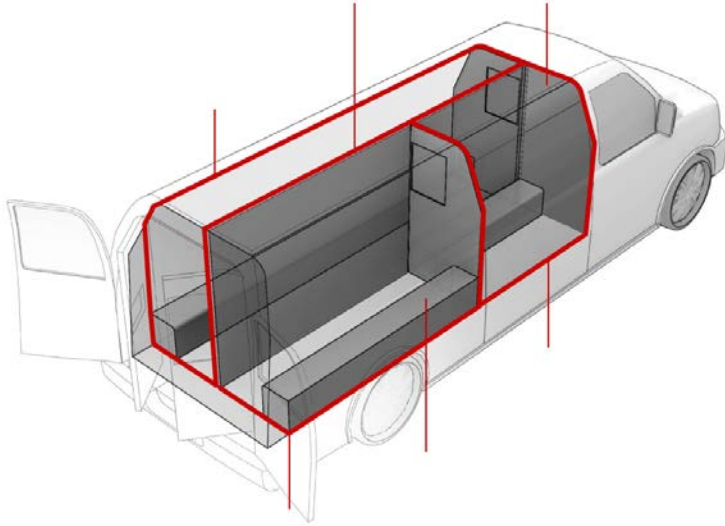

The autopsy report stated:

After the inner and outer doors were closed, it is reported that Mr. Gray could be heard yelling and banging, causing the van to rock. Originally the destination of the van was Central Booking; however, several intervening stops were made before it was finally diverted to the Western District headquarters. The 2nd stop was several blocks down (on Baker Street) to place an identification band and leg restraints on Mr. Gray. Reportedly, Mr. Gray was still yelling and shaking the van. He was removed from the van and placed on the ground in a kneeling position, facing the van doors, while ankle cuffs were placed, and then slid onto the floor of the van, belly down and head first, reportedly still verbally and physically active.⁶⁰

60. <http://www.baltimoresun.com/news/maryland/freddie-gray/bal-read-the-freddie-gray-autopsy-report-text-story.html>

Many media outlets corroborated his second self-serving, no- snitching account by pointing to the partition between the two prisoners. But an examination of the van revealed that Donta could have heard Gray through the grills in the back doors as you can see from the recreation above.

The cops know that prosecutor's office has become the Baltimore railroad. They also know of the intrigue that goes down behind the glass doors. Their attorney filed a motion asking Mosby to recuse herself:

Counsel for Defendants demand that Mrs. Mosby recuse herself and her Office from the above-captioned cases in light of the inherent and overly prejudicial conflict raised by the lead prosecutor's relationship to a potentially vital witness who is also a key member of the local media.

Jan Bledsoe, Esq., Deputy State's Attorney and lead prosecutor for the state, is in a relationship with Jayne Miller, an investigative reporter for WBAL-TV. This relationship was confirmed by Jayne Miller to the *Baltimore Sun*, as recently as Friday, May 1, 2015.

On April 27, 2015, a search warrant was executed on the home of Officer Caesar Goodson. According to the affidavit attached the search warrant Donta Allen, the only other person in the back of the van with Mr. Gray during the ride indicated to homicide detectives on the day of Gray's arrest that in his opinion "Mr. Gray was trying to hurt himself." (See Attached Exhibit 6, Search Warrant).

THE NEW CROW JIM

On April 29, 2015 the *Washington Post* reported that a second passenger was in the van with Freddie Gray and according to a source, the passenger heard Gray "banging against the walls" of the van and described what he believed was Gray "intentionally trying to injure himself." The *Post* article referenced the Search Warrant but omitted Mr. Allen's name, citing concerns over his safety.

On April 30, 2015, Jayne Miller of WBAL presented an exclusive interview with the second passenger, Donta Allen. When interviewed by Jayne Miller of WBAL the individual who was in the van with Mr. Gray somewhat retracted his earlier statement. He now stated that he heard "light banging" and that he "never ever said to police that [Gray] was hurting himself."

During this interview with Ms. Miller, Allen described a barrier which divided the rear of the van into two sections and as such, Allen stated that not only did he not see Gray, or realize there was a second passenger, but that "there's no place where a man can hurt himself in here."

After Jayne Miller's interview with Donta Allen, it became clear that Mr. Allen's story had changed. Accordingly, Miller necessarily becomes either a substantive witness or an impeachment relative to the veracity and detail of Mr. Allen's story.

After Mr. Allen's interview with Jayne Miller, the *Washington Post* did go on to release his name. There is simply no way around this conflict. It is unclear how Jayne Miller of WBAL learned the identity of the otherwise anonymous passenger.

However, the fact remains that Miller interviewed Mr. Allen PRIOR to Mrs. Mosby and Ms. Bledsoe filing criminal charges against the defendants and prior to the results of the police investigation being turned over to the State's Attorney's Office. That interview, therefore presumably was considered in the decision by the State's Attorney's Office to have charges filed.

The conflict is truly problematic in that Mr. Allen presented a different version of events that is more beneficial to the State's theory of the case in speaking with Ms. Miller. Thus, Defendants would have an opportunity to examine Ms. Miller as to the nature of her conversations with Mr. Allen prior to his interview, any statements he said while not being recorded, and by statements he made as to why he had varying accounts of key testimony in the case.

Ms. Miller may also need to testify as to the authenticity of the recording of Mr. Allen. Ms. Miller and her notes have already been requested and subpoenaed by Defense counsel.

In further recognition of the inherent conflict, on May 5, 2015, Jayne Miller stated ("I'm actually going to be covering less of [the Freddie Gray case] , because I have a personal connection to one of the prosecutors." Counsel for Defendants avers that this conflict has created the need for the parties involve thus far to recues themselves.

As others, including Jayne Miller herself have recognized this conflict of interests and recused herself, Mrs. Mosby should also recognize this

THE NEW CROW JIM

undisputed conflict and recuse herself from any further prosecution in the above-captioned cases. This conflict is real and undeniably intertwined with the prosecution and charging decision of this case.⁶¹

Mosby replied:

Essentially, Defendants claim that one Donta Allen was a passenger in the police wagon with defendant Gray during part of the time that Mr. Gray was in the same wagon. Although Defendants have had no legitimate access to Mr. Allen's recorded statement to the police, on the basis of *a snippet* of the statement in a search warrant affidavit they claim that his statement is helpful to them.

The information in a search warrant is not some post on the internet. It has substantial evidentiary value. Mosby continued:

Subsequent to his giving the statement, their story goes; television reporter Jayne Miller had an "exclusive" on air interview with Mr. Allen in which he "somewhat retracted" his statement to the police. Defendants' Joint Motion to Dismiss and in the Alternative for Recusal of Baltimore city state's Attorney's office hereafter Defendants' Joint Motion. Consequently, Defendants claim, Ms. Miller becomes a substantive or impeachment witness. Because Ms. Miller is in a relationship with a Deputy State's Attorney working on the above captioned cases, Defendants claim "there is no way around this conflict."

61. <https://www.scribd.com/doc/264688411/Baltimore-Police-Motion-for-SA-Recusal>

And for good measure, without any basis or evidence, Defendants insinuate that Ms. Miller learned the identity of Mr. Allen through her relationship with the Deputy. After detailing the existence of the personal relationship, Defendants write: "It is unclear how Jayne Miller of WBAL learned the identity of the otherwise anonymous passenger." ***This lurid tall tale about the Deputy violating her oath of office to leak confidential information to her domestic partner in order to change a witness' story lacks only one element: the truth.*** The fact of the matter is that Ms. Miller's interview was the second interview given by Mr. Allen. Michael Schuh, a television reporter for Channel 13, did an interview of Allen, substantively the same as Ms. Miller's, that took place before Ms. Miller interviewed him. Channel 13 boasted that Mr. Schuh was the first to speak with Donta Allen: "WJZ's Mike Schuh is the first to speak with Donta Allen about what he heard."

Mosby is accusing the cops of gay baiting with a lurid tale of two lesbians divulging information between the sheets. The evidence that Jayne Miller was not the first to interview Allen relies on a newscasters boast rather than comparing the dates of the two news reports which she fails to do. Mosby is a dangerous liar. Mosby:

Defendants can get Mr. Allen's "changed" story from Mr. Schuh. If a court did not determine Ms. Miller's story to be cumulative evidence, they could get her interview without needing to call her as a witness.

THE NEW CROW JIM

And if they want her as a witness to provide cumulative and redundant testimony, that does not create a conflict for the States Attorney's Office.⁶²

The Maryland State's Attorney's office used its connections in the media to discredit witness Donta Allen whose testimony could exonerate the policemen. If Donta Allen goes back to his original, less self-serving story at trial he will not last long in the hood.

Sources said the medical examiner found Gray's catastrophic injury was caused when he slammed into the back of the police transport van, apparently breaking his neck; a head injury he sustained matches a bolt in the back of the van. I assume this was a protruding bolt rather than the head of a round shaped one. Gray had a lot of room to bounce around him yet he landed in the most deadly area. Was this deliberate? Mosby:

Officer Miller and Nero then handcuffed Mr. Gray and moved him to a location a few feet away from his surrendering location. Mr. Gray was then placed in a prone position with his arms handcuffed behind his back. It was at this time that Mr. Gray indicated **he could not breathe** and requested an inhaler to no avail.

Another indication that this unstable crack and smack dealer set up the cops with his plea to the officers "I can't breathe." That is straight Eric Garner, a "Lucie" (individual cigarette) street dealer who provided cover for crack and smack dealers. Garner died while he was resisting arrest after cops in Staten Island, New York, had him in a chokehold for a few seconds. Mosby's press release:

62. <https://www.scribd.com/doc/269175277/State-Attorney-Response-to-Defendant-Motion-for-Recusal-of-Marilyn-Mosby>

Officer Miller and Nero then placed Mr. Gray in a seated position and substantially found a knife clipped to the inside of his pants pocket. The blade of the knife was folded into the handle. The knife was not a switchblade and is lawful under Maryland law. These officers then removed the knife and placed it on the sidewalk.

Of course it was closed. Who carries around an open spring assisted knife? What's the purpose of the spring? The whole idea is to deploy the weapon quickly and stab and slash your victim or opponent with it. Additionally it doesn't matter if the blade of the knife was folded into the handle if it was it was a dangerous weapon:

Md. CRIMINAL LAW Code Ann. § 4-101 (2012)

§ 4-101. Dangerous weapons (c) Prohibited. —

(1) A person may not wear or carry a dangerous weapon of any kind concealed on or about the person.

(2) A person may not wear or carry a dangerous weapon, chemical mace, pepper mace, or a tear gas device openly with the intent or purpose of injuring an individual in an unlawful manner.

(3) (i) This paragraph applies in Anne Arundel County, Baltimore County, Caroline County, Cecil County, Harford County, Kent County, Montgomery County, Prince George's County, St. Mary's County, Talbot County, Washington County, and Worcester County.⁶³

63. <http://law.justia.com/codes/maryland/2010/criminal-law/title-4/subtitle-1/4-101>

THE NEW CROW JIM

The knife was spring assisted and illegal under Baltimore Police Ordinances.

ARTICLE 19 POLICE ORDINANCES
(As Last Amended by Ord. 15-365)
§ 59-22. Switch-blade knives.

(a) Possession or sale, etc., prohibited. It shall be unlawful for any person to sell, carry, or possess any knife with an automatic spring or other device for opening and/or closing the blade, commonly known as a switch-blade knife.

(b) Penalties. Any person violating the provisions of this section, shall, upon conviction thereof, be fined not more than \$500 or be imprisoned for not more than 1 year, or both, in the discretion of the court.

(City Code, 1950, art. 24, §155; 1966, art. 19, §160; 1976/83, art. 19, §185.) (Ord. 44-057.)⁶⁴

The statement the knife was legal was another indication that Marilyn Mosby, who once appeared on the Judge Judy television show which is known for showcasing African-American trash, was out to railroad the Baltimore Police officers. The knife was illegal under Maryland State law and illegal under Baltimore City law. Mosby knew that but lied so that she could add an illegal arrest charge to rest of the preposterous charges against the cops that got caught up in the anti-cop hysteria that has swept the nation.

In June 2015 Mosby went to court to seek a protective order to insure the autopsy report would not be made public. She also

64. <http://www.akti.org/news/city-of-baltimore-code-regarding-switch-blade-knives/>

A. J. WEBERMAN

refused to turn over a copy to the police. Defense attorneys contend prosecutors discussed the case with Assistant Medical Examiner Carol H. Allan before she issued her opinion as to the cause of Gray's death. The defense also contends that prosecutors wrote affidavits about Gray's interaction with police that law enforcement officials then swore to and gave police advice and input during the department's investigation into Gray's death. The judge in this matter is a civil rights activist so these cops are goners. Their only hope is a change of venue.



Judge Barry Glenn Williams Associate judge, Baltimore City Circuit Court, since December 2005 denied the defenses motions but granted the defendants separate trials. Williams led court's criminal division from 2012 until January 2015.

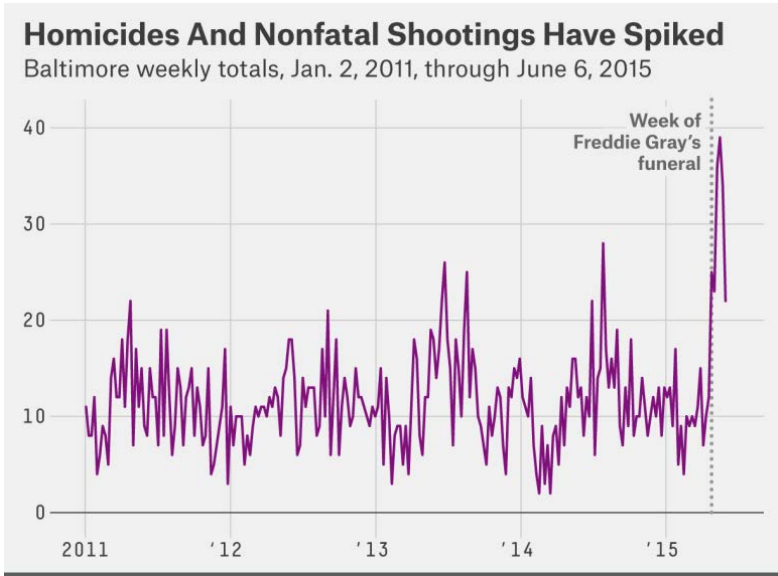

He chaired Criminal Justice Coordinating Council for Baltimore, 2012-2014. As you can see from the above chart he did not do such a good job. He was Special litigation counsel for the civil rights division of the U.S. Justice Department, 2002-2005 and a trial attorney in the civil rights division of the U.S. Department of Justice, 1997-2002.⁶⁵ In other words he prosecuted racially charged cases such as this one. Judge Williams was Assistant state's attorney in Baltimore, 1989-1997

From 1987 to 1988, Judge Williams served as law clerk to Judge Arrie W. Davis, who was then a judge with the Baltimore City Circuit Court. From 1988 until 1989, he was law clerk to now Chief Judge Robert M. Bell, then with the Court of Special Appeals.

Robert Mack Bell (born July 6, 1943) is an American lawyer and jurist from Anne Arundel County, Maryland. Since 1991 he has been a judge of the Maryland Court of

65. <http://mdcourts.gov/media/news/2011/pr20111205.html>

Appeals, the highest court in Maryland, and it's Chief Judge since 1996.

While attending Baltimore's Dunbar High School there in 1960, Bell had his first experiences with the judicial system. He joined a group of students in a sit-in protest at a segregated restaurant. He was arrested, convicted of trespassing, and fined \$10. His appeals went as far as the U.S. Supreme Court where he was represented by Thurgood Marshall. While the case was returned to state courts, his conviction was ultimately reversed in 1965.⁶⁶

The Johns Hopkins's Institute for Policy Studies found some interesting facts about race, ethnicity in Baltimore. The racial makeup of the city has changed. In 1980, the majority of Baltimore neighborhoods (54 percent) were predominantly White; by 2000, only 28 percent were.⁶⁷ Baltimore City has lost 36 percent of its population since 1980. Judge Williams was part of a city and civilization in decline, another failed attempt at a New Reconstruction. He will continue to contribute to it by railroading the police. Judge Williams ruled against a change of venue. Those cops will never be able to get a fair trial in Baltimore, or anywhere in Maryland, because you'll never find twelve people to serve on a jury - let alone 72 to serve on six separate juries - whose opinions have not been tainted by 24/7 media coverage, injury, damage, inconvenience by the riots, or prior interaction with Baltimore City PD. The jurors will know that a verdict of innocent means more rioting this time in the few White neighborhoods that are left in Baltimore.

66. http://www.conflict-resolution.org/sitebody/education/lecture_series/Bell.htm

67. <http://www.baltimorefishbowl.com/stories/baltimores-changing-demographics-not-what-you-might-think/>

THE NEW CROW JIM

It is absolutely ludicrous to think that these will be anything but show trials designed to appease the angry masses of Blacks who want to lynch six cops. The cops all asked for a bench trial. As it turned out Judge Williams allegiance was to justice rather than lynching and he acquitted four of the defendants of the most serious charges. After this prosecutors dropped all charges against three Baltimore police officers accused in the arrest and death of Freddie Gray, bringing to an end one of the highest-profile cop lynching cases in the city's history with zero convictions.

Mosby acknowledged the long odds of securing convictions in the remaining cases following the acquittals of three other officers on similar though more serious charges. In a hearing meant to start the trial of Officer Garrett Miller, prosecutors dropped their cases against him, Officer William Porter and Sgt. Alicia White. Circuit Judge Barry G. Williams, who had acquitted the other officers, was expected to preside over the remaining trials as well. Why did Mosby take this case to the extremes she did? She hates cops like the rest of her family does.

"I KNOW THE MAJORITY OF POLICE OFFICERS ARE OUTSTANDING, DEDICATED, LOYAL PUBLIC SERVANTS, JUST LIKE MY FAMILY." – MARILYN MOSBY.

When Mosby was accused of being anti-police she pointed to the fact that she descended from a long line of law enforcement personnel. I checked out her family background and turned the information over to the *Baltimore Sun*. *The Sun* sent a reporter to Boston who unearthed even more information on her.

Mosby also said that she hated criminals because her cousin was mistaken for a crack dealer and killed. But investigation reveals that her cousin, photo below, was in fact dealing crack.

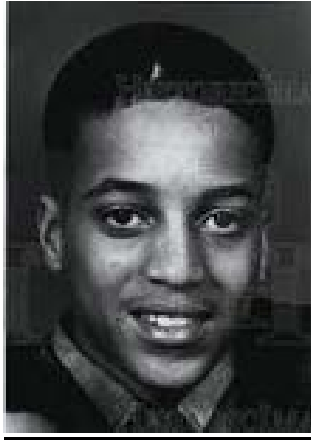

THE BOSTON POLICE DEPARTMENT COVERS UP THE FACT THAT DIRON SPENCE, MOSBY'S COUSIN, WAS DEALING CRACK

"I want to know why," said Preston Thompson, holding a copy of the *Boston Herald*, which reported yesterday that police said the shooting may have occurred over a drug deal gone bad. "Why, every time a Black boy is killed in Dorchester you have to mention drugs? My son was a good boy. *He wasn't involved in drugs or any crime.* He was a good student and I'm very proud of my son. It really hurts me you put this in the newspaper. Please back off. You got what you need. My son is dead."

The *Boston Herald* looked back at Marilyn Mosby's life in Boston:

Mosby was a 14 year old mourning the death of **her cousin** outside the door of her family's home in Dorchester in 1994. **Diron Spence**, who was 17, was shot and killed **on his bicycle** by another 17-year-old who had demanded money from him, according to prosecutors.

THE NEW CROW JIM

Family members said they believed Spence was mistaken for a drug dealer. She recalled watching her cousin's killer sentenced to life in prison in Suffolk Superior Court in 1996.

This is how the *Boston Herald* August 22, 1994 reported the murder:

The stepfather of a 17-year-old boy who was shot and killed Friday night ***as he sat on a bicycle a few feet from his Dorchester home*** said yesterday he believed his stepson's death was a case of mistaken identity. *"My personal opinion is that the gunman probably thought my son was a runner, carrying drugs or carrying money,"* said **Preston Thompson**, a Boston police officer.

Diron Spence, Thompson's stepson, was gunned down around 8 p.m. across from his grandfather's home *while on his way to visit his girlfriend*. Within minutes of the shooting, Kevin Denis, 18, of Dorchester was arrested and charged with possession of a firearm and, later, with homicide.

Spence's family talked of Spence: *"Some have tried to link Spence to drugs and crime, instead of accepting that the Lynnfield High School student was an innocent victim,"* said **Prescott Rick Thompson**, the boy's grandfather.

The killer may have noticed the saddle pouch attached to the bicycle, which Spence borrowed from his father, and thought Spence was using it to store drugs or money, said Preston Thompson, who is assigned to the operations division at Boston police headquarters.

Spence's grandfather **Prescott Rick Thompson** said after hearing gunshots, a neighbor allegedly noticed Denis running from the corner of McLellan and Bradshaw streets. The man followed Denis, watching him pull a ski mask from his face and walk toward a house on nearby Fowler Street, the grandfather said.

The neighbor phoned police on the cellular phone he carried, prompting officers to discover Denis 15 minutes after the shooting, hiding in a home on Fowler Street with a handgun by his side, *said grandfather Prescott Rick Thompson, a former Boston police officer*. Denis was "known to police," said Boston Police Deputy Superintendent James Claiborne yesterday. Claiborne refused to explain how Denis was known and if he previously had been arrested. A law enforcement source says Denis was arrested once as a juvenile, although the source did not know the nature of the charges. Claiborne said police still are investigating motives in the case.⁶⁸

Preston Thompson covered up the fact his stepson was out in the streets dealing crack by inventing a bicycle. According to Appellate Court records⁶⁹ here is what really happened.

On the evening of **August 19, 1994**, the victim, seventeen year old Diron Spence, *stood on the corner of McLellan and Bradshaw Streets in the Dorchester section of Boston, talking to his friend, Cavell Rice*. Two young women, friends of Spence,

68. <http://www.bostonglobe.com/metro/1994/08/21/mistaken-faulted-slaying-boston-officer-stepson/swOBhknBwMdPueMCwRyUPO/story.html>

69. <http://caselaw.findlaw.com/ma-supreme-judicial-court/1429793.html>

THE NEW CROW JIM

were walking down Bradshaw Street, and **paused briefly** to speak with Spence before continuing on their way down McLellan Street.



Roxbury, Dorchester and Mattapan⁷⁰ are the crime ridden parts of Boston. The homies **stood** on the street, no mention of a bike. The young women paused briefly to purchase crack from Mosby's cousin.

Moments after the women passed by, the defendant, wearing Black pants, a Black jacket, and a Black ski mask, approached Spence and Rice and demanded their money. Rice immediately began emptying his pockets, but Spence just stood there.

The defendant asked, "Think I'm playing?" He then pulled out a .357 Magnum revolver and shot at Spence from a distance of a few feet. As that first shot was fired, Rice ran away, without turning over any of *the contents of his pockets*. Four more shots were fired; three bullets hit Spence, including a fatal wound to the chest.

70. <http://www.city-data.com/forum/boston/1344407-why-do-people-overreact-about-roxbury-4.html>

Kevin Denis,⁷¹ 20, of Dorchester came up with this “self-defense” story:

He explained to the officers that, for reasons of personal safety, he often carried a gun when he was out on the streets. He had been walking by himself when he came upon Spence and Rice, who were “just staring” at him. *Spence laughed at him*, and then turned away “as if he's going to grab something.” The defendant “wasn't sure” what Spence might have been going to grab- it “could have been a knife” or it “could have been nothing.” The defendant then fired “about three” shots at Spence, “hit him once or twice,” and then fled to his friend's apartment on Fowler Street.

There, he removed his jacket and put the gun under a towel on the washing machine. He said that he could not remember what he had done with his cap. He denied that his face had been covered during the incident.

Press reports concerning Spence's death and dope dealing relied heavily on Officer Preston Thompson, another crack head. Here is a court document indicating that Mosby comes from a family of crack heads.

1. Preston Thompson. The Appellant, Preston Thompson, grew up in Boston, Massachusetts. He graduated from Boston Technical High School in

27. Race: Black Gender: Male Custody Status: In Custody Location of Offender: MCI Norfolk (Medium Security) MCI Norfolk (Medium Security) 2 Clark Street P.O. Box 43 Norfolk MA 02056

THE NEW CROW JIM

1973. He comes from a family of police officers. He became a BPD police officer in June 1979 and served through August 2001. During his 22-year career with the BPD, his hair color was Black. At some point in his career he served as a union representative. He had no prior record of discipline.

2. For most of his career with the BPD, Mr. Thompson worked as a patrol officer. Approximately eight years prior to his discharge, as a result of work-related injuries, he requested a transfer to BPD headquarters and was assigned desk duty as a dispatcher. He was on injured leave beginning in January 2001 until his termination. After his discharge, Mr. Thompson filed for an accidental disability retirement which was approved and became effective in or about October 2003.

3. *Mr. Thompson admitted to having experimented with drugs in high school and briefly thereafter, including smoking marijuana and snorting cocaine approximately half a dozen times, when provided to him by friends.* He is a social drinker of alcohol. He denies using illegal drugs for recreation, to relieve pain or stress, or for any other purpose at any time since becoming a BPD police officer in 1979.

4. Mr. Thompson's annual hair test for drug use in 1999 administered by the BPD was reported negative. *His 2000 annual hair test was positive for cocaine but reported as negative after additional testing.*

5. At the time of the Commission's hearing, Mr. Thompson was employed part-time as a security guard at the Massachusetts College of Pharmacy.

6. Preston Thompson. Officer Thompson tested positive on his initial 2001 hair test at 13.7 ng/10mgCOC, with BE at 13.6% and 3.96ng of CE. His follow-up two weeks later was consistent at 13ng/10mg COC with BE of 13.9% and 4.57ng of CE. These levels of COC – nearly three times the cutoff under any set of protocols now employed or previously employed by Psychemedics in testing BPD officers – add sufficient additional force to the test results.

When Mr. Thompson's 2001 test results are taken together with his earlier hair test history, which, although ultimately declared negative officially, also showed results considerably above cut-off which were discounted to give him the "benefit of the doubt" and the absence of any evidence of specific exposure that would explain these elevated levels, **the preponderance of evidence supports the conclusion that Officer Thompson had used cocaine.** It is also relevant that Officer Thompson was on medical leave, recovering from injuries suffered on duty (which eventually resulted in qualifying for disability retirement) and he had not performed the duties of a BPD officer for nearly six months prior to his 2002 hair test.

Officer Thompson did not seek or obtain an independent hair test. As a result, the BPD had just cause to terminate him. For the reasons stated, the appeals of the Appellants, **Preston Thompson**, Oscar Bridgeman, William Bridgeforth and Rudy Guity are dismissed.

PRESCOTT R. THOMPSON SR

Marilyn Mosby's baby mom, Linda Thompson, was 17 when Mosby was born so Thompson's parents helped raise their granddaughter. She told the *Boston Globe* she and her mother "grew up like sisters." Linda Thompson is a retired Boston police officer. Mosby's grandfather, Prescott Rick Thompson Sr., served on the Boston Police Department and was a founding member of the Massachusetts Association of Afro-American Police (now known as the Massachusetts Association of Minority Law Enforcement Officers, or MAMLEO). Sounds like a stand up guy however the purpose of MAMLEO was to screw over White cops.

The Massachusetts Association of Minority Law Enforcement Officers (MAMLEO) appeals from a ruling of a judge in the Superior Court upholding a decision of the Civil Service Commission that the police department of Boston improperly promoted certain minority police officers to the ranks of sergeant and lieutenant over nonminority defendants with higher test scores. MAMLEO, a plaintiff intervener in the Superior Court proceeding and not a party to the original proceedings before the commission, argues that the judge erred as a matter of law in upholding the commission's decision, and abused his discretion in denying MAMLEO's motion to supplement the administrative record.

Prescott Rick Thompson Sr. eventually turned on the Boston Police Department and became another former policeman turned cop-hater.

X-COP SUES FOR REINSTATEMENT

With one glass eye and 61 years on his barrel-chested body, **Prescott (Rick) Thompson** stepped up last August to take the physical exam, once again, to become a Boston police officer. He did 20 sit-ups. No problem. Then came the agility test, where he was asked to run a gauntlet of exercises in 18.6 seconds or less. He did it in 19, less than a half-second off. The police instructor asked him to do the test again. Thompson complied but pulled a hamstring muscle, rendering him useless for the second agility test and the mile-and-a-half run, which he still completed by power walking his way to the end. He was two minutes over the limit.

"I tried my best," he said. "But no man alive could have passed that test with a pulled muscle." To regain his job on the force, Thompson must wait for the next Police Academy class and for the resolution of a suit pending in Suffolk Superior Court, where he is charging the Boston Police Department with ***discrimination based on his race*** and handicap.

Although police officials would not comment on the case, citing pending litigation, court documents show that Police Commissioner Francis M. Roache refused to reinstate Thompson in 1986 because of his eye injury. "Sight in two eyes is a bona-fide Occupation Qualification for the position sought," Roache wrote in a letter to Thompson.

Police lawyers also asserted in court papers that their decision not to reinstate Thompson, who is Black, has nothing to do with his race but rests on state and city laws regulating reinstatement. But by

THE NEW CROW JIM

its own admission, the Police Department has allowed at least four officers, all of whom are White and have the use of only one eye, to work for the department. Though the causes of their injuries were not detailed during the deposition, Callahan said that the four officers had different jobs within the department, ranging from a clerk to a hazardous materials inspector.

"He can do anything that a police officer with two eyes can do," said Jane Alper, Thompson's attorney with the Disability Law Center, Inc. "And the fact that all of the officers who have been allowed to stay on the force with a similar disability are White says something also."

Thompson was an officer in the '60s, patrolling the streets and gin-joints for seven years before an accident -- a car battery exploded in his face -- caused him to lose his eye in 1971. He left on disability for five years before accepting a retirement package in 1976.

But policing was in his blood. It was virtually the family business. His grandfather had been an officer in New Bedford. His uncle had been one of the first Black Metropolitan District Commission police officers. His older brother was a Boston police officer.

Four of his five children are officers. Their paths have met some resistance. *His first son from a previous marriage, Richard Miller, sued the State Police for firing him in 1981 based on discrimination. That case eventually resulted in a \$211,587 settlement in favor of Miller.*

Thompson recalled an incident which crystallized his desire to become an officer. He was young and impressionable, maybe 12 or 13 years old at the time. His brother was sick and his mother sent him around the corner to pick up medicine, he said. The pharmacy on Humboldt Avenue was closing, but the owners had the prescription ready. "Run straight home," one of the owners told him.

Just as he cleared the door, four men slammed him up against a wall. The men were plainclothes Boston police officers, he said, who did not explain a thing until the store owner opened the door. "He fits the description of a purse snatcher," Thompson recalls one of the officers barking. "He didn't do it," the store owner snapped. "His mother just sent him down here. He's got a prescription in his pocket." The officers let him go, but tears welled in his eyes as he walked back home. "I made a promise that that would never happen to me again," he said. "I never forgot that. Never." He swore that he would become a police officer, and that he would prevent that sort of treatment from happening to another Black child.

Thompson made good on his promise. He sailed through the Police Academy and became an officer in 1964. He made several high-profile arrests. *The accident happened the day after Thanksgiving in 1971.*

Thompson and three other Boston police officers drove their squad car to a city garage for routine repairs. The other officers marveled at a shipment of new cruisers while Thompson stood in front of the car.

THE NEW CROW JIM

The mechanic had raised the hood, and as Thompson turned his head to look at the engine, the battery exploded, spewing metal and acid all over his face. His right eye was torn in half. Within days, it would be replaced with glass. Getting accustomed to having one eye took a while. His depth perception was off, his mind traumatized.

The end of his career came in 1976. The Police Department asked him to accept his disability retirement, Thompson recalls. He reluctantly accepted. "I didn't fight it," he said. "I figured I could use more time to get myself together and get back on the force a few years later."

But the bug to become a police officer became too strong. Thompson attended a funeral in 1979 of a police officer who had committed suicide, and there he chatted briefly with Commissioner Joe Jordan. "He told me that I looked great and should think about coming back on the force," Thompson recalled. Thompson said he filled out the necessary papers in the personnel department but later received mixed signals from the police brass and simply waited to make it final.

Thompson's case was delayed for years. The police filed a motion asking the court to dismiss the suit, but that motion was overturned. Despite the legal delays and bureaucratic obstacles, Thompson still wants his old job back. "I still have something to offer," he said. "I'm a people person. And I'll take wisdom over force any day."⁷²

72. [City Edition] *Boston Globe* - Boston, Mass. Author: Manly, Howard Apr 10, 1994 Page: 1 Section: CITY WEEKLY

Prescott was never re-instated. He had joined the Police Department because he had a chip on his shoulder a mile wide and was able to cause them considerable trouble.

INJURED OFFICER IN GOOD CONDITION

A Boston policeman injured Saturday when a patrol car battery exploded was listed in good condition yesterday at Boston City Hospital. Patrolman Prescott Thompson, 38, of 31 Bradshaw Street, Dorchester underwent emergency surgery for acid burns in his right eye. He and partner were filling the battery with acid when the accident occurred.⁷³

Prescott Thompson lied to the *Boston Globe* reporter about how the accident happened in order to hide his incompetence. Mosby is a liar and a descendant of liars. Obviously the two Black officers failed to disconnect the cables attached to the battery while refilling it and a spark caused an explosion.

Prescott was part of *The Soul Patrol* a group of 31 Black officers who concentrated their efforts in high crime areas in an effort to increase minority confidence in the police department. The Boston Police Patrolmen's Assn., however, brought about the dissolution of the special unit, claiming reverse discrimination.

PRESCOTT JAMES' SON FROM A PREVIOUS MARRIAGE, RICHARD MILLER, WAS A CROOKED COP

EX-TROOPER CLAIMS BIAS, HARASSMENT IN LAWSUIT

As a new state trooper in 1978, Richard Miller, who

73. *Boston Globe* November 29, 1971.

THE NEW CROW JIM

is Black, signed up for a Christmas party only to find the next day someone had written next to his name, "niggers don't have Christmas."

In testimony in his race bias suit in US District Court yesterday, Miller said he regularly heard catcalls over the State Police radio, remarks that a suspect was arrested for "being Black in the nighttime," and a remark one night from a co-worker urging him to smile so he could find him. As the first witness in the civil rights case, Miller took the stand and explained incidents that were the basis of his firing in 1981 after three years on the force. Assistant Attorney General Mark P. Sutliff said in an opening statement that Miller was fired for repeated misconduct, infractions of criminal law as well as State Police regulations.

Miller said he was confronted by a pattern of discrimination dating back to the academy, when a teacher told recruits that a White Cadillac driven by a Black man with a White passenger should be routinely stopped as "suspicious."

At least three times, Miller said, his superiors advised him to tread lightly because many members of the force did not welcome Blacks and saw affirmative action as a relaxation of hiring standards.

Miller, 41, of Westborough, was fired in 1981 after an internal State Police proceeding in which he was found guilty of falsifying a police report, tampering with a breath analysis test, assaulting his girlfriend, having extramarital sex with her and failing to report her alleged suicide attempt. He was also charged

with driving to endanger the public and abandoning his post. Miller, in a lawsuit filed in 1988, claims the charges were trumped up and that the discharge was racially motivated.

Miller does not rebut all the offenses for which he was disciplined, instead saying that he was punished more severely than White officers who committed violations at least as serious. Miller said the complaints from his former girlfriend, Lois Blomberg⁷⁴ of Oxford, were filed after he ended the relationship against her wishes around the same time he and his wife, Roberta, ended a temporary separation in December 1980.

Blomberg thereafter called Miller, he said, and said she would kill herself if he did not go to her house. Miller said he went and found her drunk with no evidence of a suicide attempt.

He also denied her allegations that he struck her on two occasions. The trial board also accused Miller of "impregnating" Blomberg, but later dropped the allegation because of insufficient evidence.

From the stand yesterday, Miller acknowledged that he did go to Blomberg's home in uniform and entered her house as she tried to block him and that he told a man in her bedroom to leave or he would "punch him out." But he denied hitting Blomberg. Miller also admitted lying on a report to claim a tire blew when he lost control of a cruiser one night and that he had the tire slashed to spare him a citation for speeding. But he denied telling a fellow trooper

74. Lois Blomberg, 6 Little John Cir, Oxford, MA 01540, (508) 987-8701.

to falsify a breath analysis test to make a motorist he had arrested register as intoxicated.⁷⁵

TROOPER TESTIFIES IN RACE BIAS SUIT

A Black trooper with 13 years on the State Police force testified that when he faced disciplinary action shortly after he joined the force in 1980, he mentioned it to Miller, who is also Black, and Miller told him, **"You got nothing to worry about, they can't fire you." Garrett said that when he asked why not, Miller said, "If they fire you, just sue them for racism."**

Miller was fired in 1981 for a variety of offenses, including assault and battery on a woman with whom he was involved, falsifying an accident report after wrecking a cruiser, falsifying an alcohol breath test and driving at excessive speeds.⁷⁶

JURY FINDS BIAS IN TROOPER FIRING

Finding evidence of racial bias in the State Police, a federal jury ruled yesterday that Richard Miller was fired as a trooper in 1981 because he is Black, and awarded him \$211,587 in back pay. State Police officials had contended Miller was discharged because he physically abused his girlfriend and urged another trooper to tamper with an alcohol breath test.

75. [City Edition] *Boston Globe* - Boston, Mass. Author: Rakowsky, Judy Jan 12, 1994 Page: 15 Section: METRO/REGION

76. [City Edition] *Boston Globe* - Boston, Mass. Jan 21, 1994 Page: 23 Section: METRO/REGION

But Miller successfully countered that over the years White troopers who committed more serious offenses were not fired. "All I wanted was to be treated like everyone else," Miller said, as he wiped tears from his eyes after the verdict was read. **The jury rejected his claim for damages for emotional distress.**

US District Judge Nathaniel M. Gorton still must decide whether Miller, 42, of Westborough, will be reinstated as a trooper or, if not, if he is entitled to the difference between his future earnings as a truck driver and what he would earn as a trooper.

"The verdict is a condemnation of the State Police. The evidence of racial prejudice was overwhelming and this jury believed it," Jonathan Shapiro, Miller's lawyer said. "It's important to send a message to the State Police to change its ways. There was evidence that it {racial bias} hasn't stopped." He pointed to testimony about a 1992 meeting concerning the consolidation of several police forces. At the meeting, one White trooper said he would not take orders from a Black female lieutenant from the Metropolitan Police. Miller's father, three uncles, two brothers and a sister have all served as Boston police officers.

Miller was found guilty in 1981 by an internal State Police trial board of conduct unbecoming an officer for conspiring to falsify a breath analysis test, assaulting his former girlfriend, having extramarital sex with her and failing to report her alleged suicide attempts. He also was charged with fleeing a

THE NEW CROW JIM

*pursuing police car, driving to endanger the public and falsifying a report about a cruiser he wrecked.*⁷⁷

TESTIMONY GIVEN ON TROOPER'S JOB

A federal judge heard testimony yesterday on whether Richard Miller should be reinstated as a State Trooper 13 years after his firing now that a federal jury found that Miller's discharge was the result of racial bias.

The jury awarded Miller \$211,587 in back pay. US District Judge Nathaniel M. Gorton heard a full day of testimony from several State Police officers and Miller, 42, of Westborough, who said that if reinstated *he is sure that his maturity would help him handle any hostility he receives from fellow troopers for suing the department. Assistant Attorney General Mark Sutliff argued that it would be too difficult to update Miller's training and it would be too disruptive for him to return to the force.*⁷⁸

There is no doubt that there was no shortage of racist cops in the Massachusetts State police but Miller's beating up his Swedish-American only reinforced their beliefs that Blacks share certain universal traits. Had Miller been reinstated he might have become the victim of friendly fire.

IN 1989 MOSBY'S FATHER, ALAN JAMES, WAS A CROOKED COP
THROWN OFF THE FORCE

77. [City Edition] *Boston Globe* - Boston, Mass. Author: Rakowsky, Judy Jan 28, 1994 Page: 17 Section: METRO/REGION Kevin B. O'Leary, Contributing Reporter

78. [City Edition] *Boston Globe*, Boston, Mass. Jun 18, 1994 Page: 22
Section: METRO/REGION

HUB OFFICERS CHARGED WITH ASSAULT, THEFT

Two Boston police officers who allegedly flashed badges and brandished guns before they robbed young men in Dorchester last weekend were arrested yesterday on robbery and assault charges, police said. Dwight Allen, 28, of Roslindale, a four-year member of the department, and **Alan James, 30, of Dorchester**, a two-year member of the force, were each charged with two counts of armed robbery and three counts of assault and battery with a dangerous weapon.

The officers were arraigned yesterday in Dorchester District Court and were being held last night in the Charles Street Jail on \$2,500 bail. Police said they are looking for a third individual; who they believe took part in the shakedowns that occurred on Norfolk and Esmond streets. During the Norfolk Street robbery, which occurred about 11:30 p.m. Aug. 19, authorities said *one of the suspects fired a gun*, but no one was injured. Police said they are investigating whether the third individual, still at large, is a police officer.

Allen, who was arrested at his home, and James, who was arrested at the Mattapan-Dorchester police station, were suspended with pay, police said. Authorities said Allen was on disability leave at the time of the shakedowns.

In March, he was escorted to a hospital by a police cruiser after he reported being shot in the leg by a man who tried to rob him as he took out trash at his Roslindale home. He was treated for a graze to his left inner thigh.

THE NEW CROW JIM

During a news conference yesterday, Police Deputy Superintendent William Celester described the patrolmen as "average officers." He said one had been disciplined in the past by the department, but he declined to identify which one. Celester said there was no evidence that the officers had engaged in the illegal activity prior to the robberies last week. "All of that is still being investigated," he said.

Shortly before midnight last Saturday, Celester said, two men who were not in police uniform, jumped out of a four-wheel-drive vehicle and approached teen-agers and young men congregated in front of a Norfolk Street apartment house. "They would pull up, get out and announce they were renegade police officers," Celester said. "Then, they would show a badge and gun and ask for a certain amount of US currency." They did not disguise themselves," he added. While at Norfolk Street, Celester said, the robbers took \$40 from one person at gunpoint and assaulted two others with the gun.

Less than an hour later, Celester said, police received reports of two men matching the same description shaking down youths on Esmond Street. Again, they flashed badges and guns, and identified themselves as "renegade police officers," he said. The victims and witnesses, Celester said, reported that the robbers assaulted several people with guns and took about \$150.

Asked whether the robbers were looking for drugs, Celester would only say that officials were investigating that possibility. Later yesterday, witnesses on Norfolk Street said they had talked to

Celester and other investigators about allegations of shakedowns for drugs. In a telephone interview, Celester said he had spoken to several witnesses at Norfolk Street but declined to disclose details of the conversations.

On Norfolk Street, two persons who said they were assaulted by the patrolmen and two others who said they notified the police noted why the officers were there. They would only give their first names. ***"They frisked me, had the gun to me and asked me where is the stuff?"*** said a young man, who called himself Phil and who said he was visiting his girlfriend. Asked what the officers were looking for, he responded: **"Crack."** Phil, who said he was not a drug dealer, said he told investigators that one of the robbers placed a cocked gun to his head and throat. He said the robbers did not want the \$80 in his pockets. "They were looking for crack," he said. When the robbers did not find crack, Phil said, one of them yelled, "We are no joke." Phil said the gunman held his gun down and fired at the top step.

Another youth, who gave his name as Chris, said he was trapped in a hallway with the robbers before he escaped. Another witness, who gave her name as Barbara, told a similar story. Both said the robbers parked their vehicle across the street and next to Walker play ground, walked up and pulled the guns from beneath their pants. They flashed a badge and said, "We're cool. We are renegade police. We just want some stuff," Chris said.

THE NEW CROW JIM

"They were drunk. You could smell the alcohol," Chris said. He said the robbers asked him, "Where is the stuff?" Phil said the robbers were not in their "right state of mind." "One of the officers was wheeling the gun in his hand," he said. Barbara, a resident of the complex, said she thought the robbers were going to arrest someone when they identified themselves as police officers.

"But when I heard them asking for money, I said something's wrong," she said. "I went inside and called police." Barbara said she called police a second time when she heard a gunshot. Neighbors said police have been known to shake down youths and young men congregating in this area of Norfolk Street. Barbara said three years ago the complex and the park used to be an active drug area. She said the drug traffic has moved on recently.

Residents say they are now leery of men who identify themselves as police officers. They said it would be hard to talk to officers about drug activities because they would have no proof that the officers are not involved in the drug trade. "You got to be careful who you trust," Barbara said.⁷⁹

(1991) POLICE OFFICER IS ACQUITTED OF ASSAULT, ROBBERY CHARGES

Boston Police Officer **Alan C. James** was acquitted by a Suffolk Superior Court jury yesterday of charges stemming from a purported assault and armed

79. *Boston Globe*, Boston, Mass. Author: Thomas, Jerry **Aug 26, 1989** Page: 17
Section: METRO

robbery of three men in Dorchester two years ago. James, 31, of Mashpee, who had been suspended with pay while the charges were pending, said he was "elated" by his acquittal but criticized the Police Department's Bureau of Professional Standards for the way it handled the investigation.

"I feel a lot of bitterness and anger because it could have all been avoided" if investigators had listened to his side of the story, said James, a father of four. Defense attorney Stephen Hrones said, "My client has always maintained his innocence. The jury got the message that he had wanted to tell his story all along." James, who testified in his own defense during his five-day trial, admitted he was at the scene when the assault and robbery took place but denied taking part in it.

James and another officer, Dwight Allen, 30, faced charges that on Aug. 19, 1989, they and a third unidentified suspect assaulted and robbed three men on Norfolk Street after flashing their badges, brandishing guns and demanding drugs.

One man was purportedly robbed of \$40 and a second in a wheelchair of a radio after the alleged assailants' demands for drugs went unmet. The third man purportedly had a gun placed to his head. James will remain suspended w/pay pending an administrative review, said Detective George Noonan, a police spokesman.

No trial date has been set for Allen, a four-year member of the force who has been extradited to Georgia to face unrelated charges. Meanwhile, David Rodman, a spokesman for the Suffolk district

THE NEW CROW JIM

attorney's office, said James' allegation in his court testimony that the third suspect is a man named Darryl Silvia of the Egleston Square section of Boston is under investigation.

James said he, Allen and Silvia had drunk a half-gallon of cognac and a case of beer when the other two men decided they wanted to get some drugs. James added that Allen was off-duty and he, James, was on injury leave and was not carrying a gun or badge. According to James, he and Allen remained in Allen's car on Norfolk Street while Silvia got out and walked across the street to get some cocaine. After Silvia did not return quickly, James said he went into 565 Norfolk St. at Allen's urging to check on Silvia.

When he entered the hallway, James said, he was surprised and scared to see Silvia holding a gun to a man's head while holding money in his other hand. James said after he told Silvia, "We don't want any money," and after Allen stuck his head in the doorway and said, "Come on," he returned to the car with Allen.

James said Silvia fired a shot into a stair before returning to the car, where, James said; he and Allen upbraided the gunman.

"He was in a drunken state and he was laughing and saying, 'I'm sorry, I'm sorry,' " testified James, who said he passed out later at Allen's house from drinking. Assistant District Attorney Lynn Beland declined comment following the verdict.⁸⁰

80. *Boston Globe* Boston, Mass. Author: Wong, Doris Sue **Apr 6, 1991**

Mosby's father was hired because he was Black.

BOSTON FORCE MUST REHIRE ACQUITTED EX-OFFICER

The Civil Service Commission has ruled that a former Boston police officer acquitted of assault and robbery charges a year ago must be given his job back because department officials violated his rights by failing to afford him the opportunity to cross-examine witnesses against him during an internal hearing. In its decision filed last week, the commission said the department erred by promising to allow Alan C. James, 33, of Hyannis the chance to cross-examine witnesses but never re-scheduling a hearing for him to do so.

Police Commissioner Francis M. Roache fired James for "conduct unbecoming an officer" on April 5, 1991, the day a Superior Court jury acquitted James of charges stemming from a robbery of three men on Norfolk Street in Dorchester on Aug. 19, 1989. Vincent Loporchio, a Boston police spokesman, said the department has not yet decided whether it will appeal.⁸¹

James never was re-instated.

In her law enforcement career, Mosby's baby mom was disciplined on nine occasions and received a 45-day suspension for violating a substance-abuse policy, according to Lt. Michael McCarthy, a spokesman for the Boston Police Department.

81. [City Edition] *Boston Globe* Boston, Mass. Author: Locy, Toni Date: July22, 1992 Page: 44 Section: METRO/REGION

THE NEW CROW JIM

Other discipline stemmed from not reporting for duty and neglect of duty, he said.

Mosby claimed her family had been in law enforcement for four generations. This addresses the issue of how many "generations" of her family were police officers. Based on all information published to date, there were only two generations of police officers--her mother and her mother's father (or Mosby's grandfather). In order for there to have been five generations of police officers in Mosby's family, her great, great, great grandfather would have been the first generation, her great, great grandfather would have been the second generation, her great grandfather would have been the third generation, her grandfather the fourth generation, and her mother would have been the fifth generation. Making an assumption on the low side that a generation equals 20 years, the first generation great, great, great grandfather would have been a policeman more than 100 years ago (or in the early 1900's).

Based on where the nation's social situation at that time, it is well nigh impossible that a "Negro" would have been a policeman at that point in history.

Based on the foregoing, this researcher is compelled to refute that there were in fact five "generations" of policemen in her family. Rather she made this remark to greatly exaggerate that her familial history of police renders her immune to bias against policemen.

On the other hand, if she doesn't know what a "generation" is, she may think each uncle--of whom there were two, her grandfather, and her mother each constitute a "generation."

In the 1998 high school yearbook, the 93 members of the senior class were asked to predict where they would be in the future. It said Mosby would be "the next Malcolm X, MLK and Farrakhan all wrapped into one, with dreads, and preaching so the whole world can hear." In other words she was a follow of the Nation of Islam. Not at all surprising. The Baltimore Police Department was demoralized by the indictment of 6 of its officers by a Farrakhan-loving State's Attorney who shouted *No Justice No Peace* after Freddie Gray died of self-inflicted injuries in police custody. The cops let the cards fall where they may. In the first week of May 2015, Baltimore City Police made 319 arrests followed by 358 arrests during the second week. By comparison, the average number of weekly arrests from March 14, 2015 to April 25, 2015 was 626. In 2014 between May 10 and May 31, police arrested an average of 856 people a week.

More than 200 people were arrested during the worst of the rioting April 27, with more than 350 businesses damaged, 113 officers injured, and 19 buildings and 144 vehicles set on fire but Mosby handed down only one indictment. Raymond Carter, 24, was charged with being the sole person responsible for burning down the CVS pharmacy during the Freddie Gray riots. By August 14, 2015 there were 200 homicides in Baltimore, Maryland.⁸²

Mosby tried to account for this spike in murders by blaming it on a lack of trust in the police "This is the home of witness intimidation, where that 'Stop Snitching' mentality began. We have to build the trust of the community back up." She pointed to the conviction of Darrel Martin Anderson as a great accomplishment of her office. At his trial Anderson told Mosby to go fuck herself.

82. <http://www.baltimoresun.com/news/maryland/crime/blog/bs-md-ci-200th-homicide-20150810-story.html>

THE NEW CROW JIM



Anderson was accused of being one of two gunmen summoned to Elmora Ave. in Baltimore on June 27, 2013, by Tierra Fallin, who had an argument with another woman standing outside a home. Fallin, who believed a woman had said something about the father of two of her children, vowed to return with thugs, and later reappeared with Anderson and another man. The second man has not been identified. "Air this bitch out!" Fallin said, according to witnesses. "Do what y'all do!"

Eight people were on the porch; three were struck. Gennie Shird, 20, was killed; Cierra Williams was hit in the head and critically wounded, but has recovered. Michelle Hitchens, 51, was shot in the arm and appeared to have non-life-threatening injuries, but later developed an embolism and died. Anderson was sentenced to life imprisonment on this case, and previously life in a Baltimore County case. With witnesses who had been wounded it was a slam dunk.



The rioters in Baltimore unwittingly supported the late Senator Patrick Moynihan's contention that:

Fires are in fact a leading indicator of social pathology for a neighborhood. The psychiatric interpretation of fire-setting is complex, but it relates to the types of personalities which slums produce.⁸³

Former Baltimore Police Commissioner Batts announced 27 pharmacies were looted during the riots following the death of Freddie Gray, including two methadone clinics. "There are enough narcotics on the streets of Baltimore to keep it intoxicated for a year," said Batts. Batts blamed the flood of drugs on the streets for the surge in murders since the unrest. "Criminals are selling those stolen drugs," Batts said. "There are turf wars happening, which are leading to violence and shootings in our city."

The Drug Enforcement Administration said they already know more than 175,000 doses of prescription narcotics were stolen, but that number could as much as double as pharmacies still assess their losses.

83. <http://www.nixonlibrary.gov/virtuallibrary/releases/jul10/53.pdf>



The photograph above was released by the DEA seeking information on those who looted Baltimore Pharmacies. As you can see the entire community was involved not just young male “thugs.”

This researcher visited Marilyn Mosby’s [Facebook](#) page and found that many of her friends shared this one Facebook friend’s opinion about not snitching on the scum who looted the pharmacies:

I am asking the community NOT to report any of these people in these photos to the police or feds. Here is the reason why. Pharmacies complained last week that it took Baltimore City Police over a month to respond to calls about looting prescription drugs. One pharmacy said they called in April and the detectives didn't show-up until last week. The police and feds, in order to save face, are now on a witch hunt. In none of these photos are any of these people seen taking anything and in most cases are outside of the pharmacy. In some photos they are not even near a pharmacy.

A. J. WEBERMAN

There is NO photo evidence of these people stealing the prescription drugs Commissioner Batts say is fueling the violence in the city. We really need to get some leadership in the police department. Heber Brown III Jamye Wooten Jamye A F James MacArthur and I was outside of these establishments doing the uprising. I sure their photos of us and like the people in these photos.

Even the photo of the people with that stuff on the ground doesn't show that they stole anything from a pharmacy. ***It only shows them looking at the stuff.*** I saw all kinds on the ground that people dropped. I saw people also picking up loaves of bread and other food items to eat off the ground that had been dropped. So let's not participate in this witch hunt because of the police slowdown. A slowdown that took them over a month to respond and show up to a theft call. Please share and ask folks in y'all circle not to report these people in these photos who are shown outside of the pharmacies not stealing anything. With State Rep. Jill P Carter and 35 others.

Mayor Rawlings along with those she allowed to riot should be locked up. What if this happened in your neighborhood? Sick people couldn't get their medication due to the drug hungry African-Americans looting the pharmacies. If wage slavery continues along with Black criminal subculture things will only get worse. Right now these break-downs of civilization are confined to the Black side of town but it is inevitable that they will eventually reach the White neighborhoods and downtown business districts. Then if the cops open fire there and not in African-American neighborhoods they will be accused of being racist.

THE MARYLYN MOSBY OF ORLANDO, FLORIDA

THE NEW CROW JIM



(BNS) **Bloods News Service** Orlando residents Jayvon Joachin, 17, and Deshawn Miller smoked Kendra Lewis, 27 as the bitch drove through the parking lot of a Citgo gas station at Silver Star and Pine Hills. They aired her out good without injuring Jayvon's child seated in the back. Thanks to sister Aramis Ayala, the brothers will not be iced. The sister wormed her way into the State's Attorney's office. Our homeboy Markeith Loyd, who is charged with killing his pregnant ex-girlfriend and Orlando police Lt. Debra Clayton, ain't so lucky as the sister has been taken off her case.



The preceding "news story" was fictitious but the facts are real. Ayala has refused to pursue the death penalty period. She claims it costs more to execute somebody than to give them a life sentence with no chance of parole. According to Ayala a prisoner will be locked up for 10 years before he is executed. This is shorter than life but she factors in court costs. Her real reason is Black racism; no Blackman should die because his life has been shaped by poverty and racism. But how would she feel if her children with the victims of a homicide?

FREDDIE GRAY POST MORTEM

The opioid epidemic has claimed so many lives in Maryland that the state medical examiner's office is having trouble performing autopsies on time, officials say. Crimes in the Southern district of Baltimore increased. Nonfatal shootings are up more than 300 percent this year compared with the same time last year. Carjackings are up 171 percent. Robberies are up 59 percent.

Baltimore suffered 146 homicides through May 2015, a record. The death toll is up 32 percent over the same period last year, and nearly 85 percent over 2014. The city blew past the previous five-month high of 139 homicides in 1993. In absolute numbers, Baltimore trailed only Chicago in homicides through May.

Meanwhile in a blistering, 163-page report, federal officials documented years of unconstitutional and discriminatory policing in the city, including "clearing corners" without legal justification. Finally, two officers in Freddie Gray case sue Baltimore State's Attorney Marilyn Mosby for defamation and invasion of privacy, court records show.

1993 was a banner year for the Black Criminal Subculture however 2017 has been deadlier than 1993. The homicide rate in 2017 is 55.8 per 100,000 people. In 1993, when the city had 10 more homicides but 100,000 more residents, the rate was 48.8 per 100,000 people.

THE NEW CROW JIM

The 1,003 homicides of the past three years represent a spike. Spike is also a slang term for a needle. The total for the previous three years was 663; for the three years before that, it was 660. What's the moral of the story? Why worry about a scummy smack dealer when there is so much more to worry about? Black racism.

CHAPTER SEVEN

'BIG MIKE' BROWN THE MARTYR OF BLACK LIVES MATTER



The events in Ferguson, Missouri, gave America a new meaning for the phrase *Black Propaganda*. Black Propaganda can be defined as the spreading of false ideas, information, or rumor for the purpose of injuring an institution, a cause, or a person. That is what the whole “hands up” thing was about. The Justice Department reported that all the forensic evidence indicated Michael Brown tried to grab Officer Darren Wilson’s weapon in order to shoot him with it, got shot, ran away, then charged at Wilson after going completely haywire. Wilson kept shooting in order to save his life but Brown kept coming at him. The hands-up story was a total fabrication. It was like the KKK putting out a story that a Black they hated raped a White when it had no basis in fact. What is worse is that Michael Brown is still a hero in 99% of the African-American community! Fully 80% of Blacks say the grand jury made the wrong decision in not charging Darren Wilson in Michael

THE NEW CROW JIM

Brown's death⁸⁴ and had the jury been all Black he definitely would have been charged solely on the basis of his race.

Obama: "I think that what had been happening in Ferguson was oppressive and objectionable and was worthy of protest."⁸⁵

Every human being has a right to self-preservation, it is the first law of nature, but the vast majority of the Blacks wanted Wilson to roll over and die because he was a White devil pig. That's called Black racism. Another question arises: How many African-Americans know the hands-up story is fraudulent but *pretend* to believe it anyway as a means of retaliating against the police? Do Americans really want to be governed by the hands up crowd?

THE FERGUSON EFFECT



84. <http://www.people-press.org/2014/12/08/sharp-racial-divisions-in-reactions-to-brown-garner-decisions/>

85. <http://cnsnews.com/news/article/susan-jones/obama-tells-comedian-ferguson-situation-worthy-protest>

MICHAEL BROWN HOMEBOY TYRONE HARRIS

When African-Americans think of Ferguson, they think of Michael Brown when they should be thinking about Colin Ferguson, who was convicted of murdering six people and injuring 19 others after he opened fire on an LIRR train on Dec. 7, 1993. *Cop Killing Lobby* members William Kunstler and Ron Kuby argued that Ferguson's actions were not criminal because he suffered from "Black rage." Would Holder have opened a Civil Rights investigation into this mass murder? If Kuby defended Dylann Roof would have blamed "White rage?"

When the Michael Brown story first broke Obama and USAG Holder immediately made it into a civil rights issue by visiting Ferguson. The US Attorney doesn't visit the city of every thug killed by a police officer. Then USAG Holder asked the FBI to find evidence to indict Wilson for Civil Rights Act violations but the FBI could find none. When the Department of Justice released a report stating the "hands up" story was a fabrication Holder stated:

I recognize that the findings in our report may leave some to wonder how the department's findings can differ so sharply from some of the initial, widely reported accounts of what transpired. I want to emphasize that the strength and integrity of America's justice system has always rested on its ability to deliver impartial results in precisely these types of difficult circumstances – adhering strictly to the facts and the law, regardless of assumptions.

Yet it remains not only valid – but essential – to question how such a strong alternative version of events was able to take hold so swiftly, and be accepted so readily.⁸⁶

86. <http://www.cnn.com/TRANSCRIPTS/1503/04/cnr.07.html>

THE NEW CROW JIM

Now this is weird. The USAG is questioning the findings of his own DOJ. Paraphrased: Yet it remains not only well grounded in fact, but totally necessary, to question how the *Hands Up* version of events was able to spread through America so quickly and be believed so readily if it was not true or if there was not a grain of truth in them? Holder is saying there must be some validity to the charges against Wilson if so many of my people believed it and the DOJ and FBI covered it up. Holder believes the lying “witnesses” instead of the Department of Justice.

Or is Holder blaming it on the media? Holder encouraged the media to disseminate a false story by covering his visit to Ferguson. This visit didn’t help prevent a riot from happening there, it just encouraged it by giving Michael Brown the Department of Justice’s imprimatur.

Holder has blood on his hands for the wounding by a demonstrator of two police officers in Ferguson. When Holder said “It’s time for the Ferguson police department to *disappear*,” he crossed a fine line. “Disappear” can mean kill a member of an opposing political group; as in Latin America death squads and as in concept of “the disappeared.” This may seem implausible but this researcher will document the fact that Holder comes out of a violent part of the Left. He played along with the establishment until he was in a position of power and was essentially a Black Panther racist mole.

The hands-up *schtick* was total fantasy, notional, never happened, just made up by cop haters yet it still remains a symbol of hatred for police. The facts don’t matter to the demonstrators or to the media; all that does is their agendas.

Hundreds of people from Ferguson took part in the looting and arson engendered by a cop trying to save his own life. Each looter wearing a hoodie like Klansmen wore their sheets and masks over their faces.

A. J. WEBERMAN

Given the opportunity these Black rioters and arsonists would have strung up Wilson, just as the KKK lynched Blacks they thought were guilty and might escape punishment given a fair trial. The pendulum has swung in the other direction.

The logical extension of this almost universal thought among Blacks that *Michael Brown is a hero* is a world where law enforcement personnel have to let themselves get shot because every Black thug and gang-banger is such because of White racism, not choice, culture or other factors.

To the liberals African-Americans aren't men, but children of clay molded by society with little choice and therefore little responsibility for their actions. This would be what the world would be like if there were no cops around.



Obama continued to embrace the Michael Brown case making it a political, rather than a criminal issue by holding a meeting with other African Americans to bemoan the fate of someone who attempted to murder a policeman. This indicated Obama believed that Officer Wilson should have been indicted for killing Michael Brown and subsequently convicted.

THE NEW CROW JIM

Obama thinks exactly the same as almost the entire American Blacks do, in a distorted tribalistic versus civilized fashion, always siding with a “brother.” Obama:

As many of you know, a verdict came down -- or a grand jury made a decision yesterday that upset a lot of people. *And as I said last night, the frustrations that we've seen are not just about a particular incident.*⁸⁷

So the frustrations are not just about Ferguson, where a grave injustice occurred, but in many other cities throughout the United States.

They have deep roots in many communities of color who have a sense that ***our laws are not always being enforced uniformly or fairly.***

Are Blacks looked upon with suspicion by police because cops are racist or because after they were set free by Civil Rights legislation African-Americans have generated a subculture where there is constant violent crime and little respect for human life? Obama is firmly on the side of the protestors, not the police:

But what we also saw -- although it didn't get as much attention in the media -- *was people gathering in overwhelmingly peaceful protest* -- here in Chicago, in New York, in Los Angeles, other cities.

According to Obama, who aspired to be a Black gangster when he was younger, the media should have played down the rioting in Ferguson and focused on the peaceful demonstrations. Obama identifies with the protestors who erroneously or

87. <https://www.Whitehouse.gov/the-press-office/2014/11/25/remarks-president-immigration-chicago-il>

maliciously believe that Michael Brown had his hands up when he was shot, so therefore he believes Wilson should have been indicted for defending himself against a grunting animal. Again Obama is no different than the other African-Americans in his twisted thought. He should be saying, "Look the Brother tried to kill a police officer with his own gun so what do you expect? Find a better example of police misconduct." Or say nothing. Obama continued:

Separate & apart from the particular circumstances in Ferguson, which I am careful not to speak to because it's not my job as President to comment on **ongoing investigations** and specific cases, but the frustrations people have generally -- *those are rooted in some hard truths that have to be addressed.*

By supporting the protestors he already commented on Ferguson. The ongoing case he referred to was the Justice Department's investigation into allegations of unconstitutional policing patterns or practices by the Ferguson Police Department. Holder was threatening collective punishment of the Ferguson Police Department as retribution for the killing of the criminal Michael Brown because all the other Blacks made Brown into a hero and Holder couldn't go against the other Blacks or he would be tomin' bootlicker. Holder placed no responsibility on the population of Ferguson and his beef was with law enforcement. There were 9 Whites and 3 Blacks on the Michael Brown Grand Jury. The Brown Grand Jury was split 9 to 3. You can bet it was the non-Whites on the jury who voted to indict. Rep. Marcia Fudge, D-Ohio, chair of the Congressional Black Caucus:

The Ferguson grand jury's decision not to indict former officer Darren Wilson was yet another slap in our face. It was a painful reminder that just like with Trayvon Martin and Tamir Rice and so many others

THE NEW CROW JIM

that law enforcement officers killed - Black and brown men and boys - without repercussions.

The DOJ report proved the Black Caucus was wrong. No wonder America is becoming more and more racially divided as a result of differences in thinking between Blacks and Whites that have become apparent thanks to the Brown case. Most Whites cannot understand why the Blacks would coalesce around Michael Brown, who after robbing a convenience store, tried to murder a White police officer but failed and ended up dead. Why make this sleaze ball into a hero unless you believe you have the right to murder police because of racial injustice?

African-American commentators on CNN came up with nonsense like “Maybe Wilson should have let him steal those cigars?” or “Maybe he should have taken a beating from the Black teenager?” Follow those suggestions and civilization will break down. America would become a giant Ferguson where crime is a way of life. Notice the media never deals with why the Whites left Ferguson. Ferguson’s demographics have shifted rapidly: in 1990, it was 74 percent White and 25 percent Black; in 2000, 52 percent Black and 45 percent White; by 2010, 67 percent Black and 29 percent White.⁸⁸ It was because of urban blight brought about by the crimes committed by Blacks like Michael Brown that the Whites split. Ferguson is a crime ridden area. CNN interviewed an African-American state senator who said a Black man put a gun to her head the night before and told her to give him his car keys. She said, yes we have a problem with **poverty** here but wouldn’t say the word **crime**. The *New York Times*⁸⁹ reported:

88. <http://www.nytimes.com/2014/08/18/opinion/in-ferguson-Black-town-White-power.html>

89. http://www.nytimes.com/2015/07/09/us/hud-issuing-new-rules-to-fight-segregation.html?_r=1

The Obama administration announced an aggressive effort to reduce the racial segregation of residential neighborhoods. It unveiled a new requirement that cities and localities account for how they will use federal housing funds to reduce racial disparities, or face penalties if they fail. They are part of President Obama's attempt to address the racial imbalances and lack of opportunity that he says have contributed to unrest reminiscent of the turbulent 1960s in cities like Ferguson, Mo., and Baltimore, where African-Americans have clashed with police officers.

This is reminiscent of vest-pocket redevelopment, scattered site housing for low-income residents that Mayor Lindsey inflicted upon a dying New York City as a *coup de grace*.

Obama was intent on having honest blacks live near evil ones. The Justice Department took action against rental discrimination against convicted felons when it joined the Department of Housing and Urban Development in a case alleging housing bias against the convicted. Justice officials argued that blanket bans on renting to people with criminal records "that do not consider when the conviction occurred, what the underlying conduct entailed, or what the convicted person has done since then run a substantial risk of having a disparate impact based on race or national origin."⁹⁰

Obama knows that along with his Black brothers comes crime. Now most crime is Black on Black but Obama wants to change this so there are more White crime victims. Obama wants to

90.

<https://www.washingtonpost.com/news/powerpost/wp/2016/10/27/invisible-punishment-hits-ex-felons-for-life-doj-hud-fight-blanket-rental-bias/>

THE NEW CROW JIM

spread “Blackteria” causing Whites to leave and turn vibrant cities into hellholes like parts of Baltimore and most of Ferguson. Neighborhoods don't cause social problems; people cause social problems. It is time for us as a society to hold all African-Americans personally responsible for their actions. In areas that have torn down public housing the people who lived there didn't disappear; rather, they take their social pathologies to new neighborhoods and destroy them as they destroyed their old ones.

Julián Castro, Obama’s secretary for Housing and Urban Development, prepared a radical new regulation, “Small-Area Fair Market Rents,” designed to fund the resettlement of blacks and Hispanics into wealthy, white suburbs. The scheme mandated increasing the value of Section 8 vouchers massively in order to help the urban poor afford rent in wealthier suburban areas, in addition to providing “mobility agents” — federal real-estate agents tasked with facilitating Obama and Castro’s grand social experiment.⁹¹



Obama, the champion of Black criminals at the expense of Whites, told the Black Congressional caucus:

91. <http://www.lifetzette.com/polizette/julian-castros-american-nightmare/>

Now, I won't comment on the investigation. ***I know that Michael's family is here tonight.*** I know that nothing any of us can say can ease the grief of losing a child so soon. But the anger and the emotion that followed his death awakened our nation once again to the reality that people in this room have long understood, which is, in too many communities around the country, ***a gulf of mistrust exists between local residents and law enforcement.***⁹²

Why all the hand ringing? Why is the President of the United States mourning the death of Michael Brown, a Black thug who tried to shoot a police officer? He should have sat shiver for him if he was so broken up. Why are his parents being treated like celebrities and allowed in the White House? What Gulf of mistrust? If a gulf exists it is because of the NO SNITCHING law of the Black community where it is more important not to turn in a brother to the White devil than to enjoy a degree of civilization or people are downright afraid to do so. In the words of Jacob Dylan: "**Invisible city** where no one sees nothing."

Once again the reason for all this insanity is that President Obama is a Black Racist who believes that African-Americans bear little responsibility for their actions because their lives are shaped by White Racism. He will come to the aid of "a brother" even if it means defending a criminal act.

A **video** exists on YouTube where Obama is voting and an African-American man tells him "Mr. President, don't touch my girlfriend!" Obama responds: "I really wasn't planning on it. There's an example of **a brother** just embarrassing me for no reason." Did

92. <https://www.Whitehouse.gov/the-press-office/2014/09/28/remarks-president-congressional-Black-caucus-awards-dinner>

THE NEW CROW JIM

you ever hear him refer to a White man as brother, a word that is a sign of kinship?



In March 2015 H. Rapp Holder said that the Ferguson Police Department should “disappear.” In hundreds of interviews and in a review of 35,000 pages of Ferguson police records and other documents, Justice Department officials found that although African Americans make up 67 percent of the population in Ferguson, they accounted for 93 percent of all arrests between 2012 and 2014.⁹³

Were African-Americans being singled out or did they just commit more crime? The Whites left Ferguson because of urban decay. Urban decay is the process whereby a previously functioning city falls into disrepair and decrepitude primarily because of crime. Holder’s report caused many resignations and served its purpose to punish Darren Wilson’s fellow officers and others.

93. https://www.washingtonpost.com/world/national-security/justice-dept-review-finds-pattern-of-racial-bias-among-ferguson-police/2015/03/03/27535390-c1c7-11e4-9271-610273846239_story.html

A couple of days later 2 Ferguson police officers came within inches of disappearing shot at by at least one protester, Jeffrey Williams. Williams confessed and said he was aiming a rival gangbanger.

Williams' attorney has countered that Williams was beaten by police into wrongly confessing, an assertion that St. Louis County Police spokesman Brian Schellman has called "completely false."⁹⁴ Williams has references to going to the area where looting was going down. He has 5,000 Face Book friends, no Whites, mostly African-American females. Just as the Blacks lied about Brown having his hands up they lied about his not being a protester. Cops found the gun he used in his house and it matched the casings found on the scene so we know he was there at least once.



A PICTURE OF DORIAN JOHNSON



94. <http://fox6now.com/2015/03/16/completely-false-ferguson-police-deny-beating-shooting-suspect-jeffrey-williams/>

THE NEW CROW JIM

Dorian Johnson's⁹⁵ "hands up" lie resulted in riots, looting, and the wounding of two police officers. Yet he was never indicted for lying to a federal agent. You can thank Eric Holder for that. Dorian even lied to the FBI when he knew that surveillance video would prove him a liar. Dorian:

There was an incident at Ferguson Market where cigarillos were by law stolen but not in a manner to where it was forceful or a weapon was drawn. It was almost like he just grabbed 'em. Alright, we're at the store, he's standing in front of the clerk. And the clerk asked him what does he need? He says, he wants some cigarillos, he didn't do like a snatch and grab motion. So it's like he was just reaching into his own cabinet. He just leaned over and grabbed cigarillos. He handed me a box of Swishers small mini sixty-nine cents each. Now it's not uncommon for people to buy a whole box, awe it's probably \$50.00 at the most. Then after he gave me the box, he turned back around facing the store clerk. Now he did not grab the store clerk, he didn't do anything. He just basically stood there.



95.

<https://s3.amazonaws.com/s3.documentcloud.org/documents/1380696/int-johnson-dorian.pdf>

He went back again to grab some more cigarillos. But, again it was like reaching into your own cabinet 'cause it wasn't a snatch and grab, so it was lean forward and grab and then come back. Now, at this time I had no idea what was going on 'cause like I said, I see people buying a lot of packs of 'rillos at a point in time is not strange. It wasn't until I saw Big Mike turn without saying anything to the store clerk then walk out the exit that I figured out what was going on and so *I immediately set the box that I had that he had given to me back on the counter.*

Dorian never put down the box of cigarillos as is evident from the surveillance video above.

And, it was almost like the store clerk was in shock because if we really wanted to, we could've just ran right out the door but ***we walked straight to the door.***

The store clerk did come around and just stood in front of the door and held his hands up in a stop motion. My friend, Mike Brown, he didn't wrestle or punch the man or pull any weapon out on him. Man, he just put his hand on him, one hand, and just moved him out the way. Now, the man didn't fall on the ground so I can tell Big Mike didn't use that much force.

The man stumbled over and we continued to walk. Not run or speed walk. It was a slow walk. He opened the door and I walked right behind him. Now, we get out the store, we're back on West Florissant walkin' back to Canfield. I have nothing in my hand at that time.

THE NEW CROW JIM

The trousers that I had on had no pockets. I had on a tank top so...

Dorian was questioned by a detective about the robbery at the Ferguson convenience store:

Det: Did the store owner try to like stand in the way or anything like that?

Dorian: He tried to stand in the way.

Det: He tried to stand in the way but no one touched anyone?

Dorian: No he tried to stand in the way. Big Mike asked "*Could you get out of the way*"? and he's still standin' there and Big Mike doesn't forcefully, if it was forced, the man was small he would've hit the ground. He would have fell. He slid across the floor even. But, he didn't. He's like he almost stood over. Just stepped over.

Like he made a threat to call the police. I'm fittin' to call the police. Or he said I'll call the police.

Dorian expected law enforcement to believe Big Mike was polite and said, "Excuse me, and please get out of the way?" during a robbery? Did he think they fell off a turnip truck? He went on the reveal the true character of Big Mike – a bully "the man was so small" then finally admitted Big Mike elbowed the clerk, and pushed him out of his way.

Not only is Dorian a jive, lying motherfucker but Brown's home boy was into stealing UPS packages left on the porch of people's cribs. He didn't stop and knock on the door before he did this to find out if the people his was ripping off were Black or White, he just stole.

Dorian, 22, was arrested in June 2011 after he allegedly stole a UPS package off a front porch. He repeatedly lied to officers and told them his name was Derrick Johnson and that he was 16. He never showed up for court to answer the theft charge and a judge issued a warrant for his arrest.

And the Blacks all took the word of this thief that Brown had his hands in the air. If they trust him with this why not trust him with their UPS packages? From Father Devine of Harlem, to Louis Farrakhan, to the fortune telling ads at the back of the *Amsterdam News*, many Blacks have shown that many are easily fooled. The DOJ reported Dorian was not the only Black out to destroy the life of a cop:

Although *there are several individuals* who have stated that Brown held his hands up in an unambiguous sign of surrender prior to Wilson shooting him dead, their accounts do not support a prosecution of Wilson.

As detailed throughout this report, some of those accounts are inaccurate because they are inconsistent with the physical and forensic evidence; some of those accounts are materially inconsistent with that witness's own prior statements with no explanation, credible for otherwise, as to why those accounts changed over time.

Certain other witnesses who originally stated Brown had his hands up in surrender recanted their original accounts, admitting that they did not witness the shooting or parts of it, despite what they initially reported either to federal or local law enforcement or to the media. Prosecutors did not rely on those accounts when making a prosecutive decision.

THE NEW CROW JIM

Big Mike never had his hands in the air as a sign of surrender. Many of these reports were from people who hated the police and made up lies. For example the DOJ reported:

Witness 128 has been convicted of multiple felonies including crimes of dishonesty, all of which would be admissible in federal court as impeachment evidence. Witness 128's accounts are inconsistent with each other, inconsistent with the forensic and physical evidence, and inconsistent with credible witness accounts.

Accordingly, after a thorough review of the evidence, federal prosecutors determined this witness's accounts to lack credibility and therefore do not support a prosecution of Darren Wilson.

Witness 10, however, told the truth:

The officer fired several shots at him and to give an estimate, I would say roughly around five to six shots was fired at Mike Brown. Mike Brown was still coming towards the officer and at this point I'm thinking, wow, is this officer missing Mike Brown at this close of a range. Mike Brown continuously came forward in the charging motion and at some point, at one point he started to slow down and he came to a stop. And when he stopped, that's when the officer ceased fire and when he ceased fire, Mike Brown started to charge once more at him. When he charged once more, the officer returned fire with, I would say, give an estimate of three to four shots. And that's when Mike Brown finally collapsed.

Witness No. 10 testimony is consistent with the forensic evidence — e.g. Brown’s DNA in the car, all bullets holes in the front of Brown’s body and with a downward trajectory. In addition, this witness made his original statement within 48 hours of the incident, before any autopsy and before any media reports on the physical evidence. His subsequent testimony to the grand jury matched his original statement. As noted, it also matches Wilson’s account, which was not available to Witness 10 when he made his initial statement.

Witness No. 10 wasn’t the only person who testified that Brown charged Wilson. There were, however, some witnesses who provided very different accounts. Indeed, PBS has said that its “data” showed that “more than 50 percent of the witness statements said that Michael Brown held his hands up when Darren Wilson shot him. (16 out of 29 such statements).”

This gives us an idea of what a cross-section of the Black community is like. About half are willing to make up a lie in order to frame a police officer for cold blooded murder.

WAS THIS INCIDENT A DELIBERATE PROVOCATION?

Did Big Mike want a confrontation with the police? Dorian Johnson stated the store clerk said he was going to call the cops yet the two scumbags walked out of the store rather than running out and begin walking down the middle of the street carrying the swag. Officer Wilson’s testified that he stopped Brown because he fit the description of one of the men involved in the convenience store robbery. Brown reached in through the window of his patrol car and attempted to grab his gun.

THE NEW CROW JIM

The first thing Big Mike does is grab for Wilson's weapon? Was he going to shoot Wilson over a box of 'rillos? Strong arm robbery is not a capital crime and Big Mike would only get a slap on the wrist, probation, if he copped a plea. What was Brown going to do with the gun if he took it away from Wilson? Was he going to run off with it and sell it or was he going to shoot Wilson with it? Big Mike could have killed Wilson when the gun went off in the car but things didn't work out as planned and the wrong person got shot, namely the genius Big Mike. Big Mike then started to run and was told to stop by Wilson. If he gave himself up he would have been facing charges involving attempted murder of a police officer.

Now Big Mike had less to lose by taking out Wilson. He was already going to the joint for attempted murder of a police officer. His future as a ghetto hero or ghetto martyr depended on taking out Wilson so he charged at him. Wilson fired but by this time Brown had reverted back to an animalistic state. Because of this transformation the bullet didn't faze him and he kept moving closer to Wilson. By this time Brown wanted to die and made a motion that looked like he was packing and was about to cap Wilson.

Witness No. 10's testimony matches Darren Wilson's in every important detail. He saw Brown inside the police car window, heard a shot, and saw Brown running away (from this, the witness initially feared that Brown had killed the officer). Witness No. 10 then saw Wilson pursue Brown with his gun drawn, but not shooting. Brown then *turned around* and made **"some sort of body gesture."** The witness wasn't sure what the gesture was, but stated, "I could say for sure he never put his hands up after he did his body gesture." Instead, "he ran towards the officer full charge." Moreover, according to Witness 10, Brown began charging immediately after making his "body gesture," which the witness described as "like a shoulder shrug or him **pulling his pants up.**"

Wilson had no time to think “If he had a gun all along why didn’t he use it? Why did he go for my gun?” Wilson had no choice but to shoot Big Mike in his Little Brain. And there our myth begins. Big Mike ascended to gangbanger heaven, replete with 18 virgin chicken heads, Glocks everywhere you look and Colt 45 coming out of the faucets instead of water. But not only would Big Mike become a hero of the Ferguson thugs he became a hero of almost the entire Black community like Emmet Till or the Scottsboro Boys. This is a sad commentary on African Americans.



John Lennon wrote a song entitled *A Working Class Hero Is Something to Be*. The Black version is *A Cop Killing Hero Is Something to Be*. This makes sense in light of the Black Criminal Subculture whose natural enemy is law enforcement. Lawrence

THE NEW CROW JIM

Campbell, who was shot dead by police in Jersey City after he killed 23-year-old Police Officer Melvin Santiago was hailed as a hero by the Black community there.⁹⁶

A large memorial was erected on his behalf. His wife told the media that she was sorry he didn't kill more police. This might give you some idea of Brown's motivation. Brown told Wilson "You're too big of pussy to shoot me." Brown had come out that day with the intention of proving the cops were pussies by shooting at least one with his own police-issued gun.

After his friend went down Big Mike's homeboy, Dorian Johnson made up the story that Big Mike had his arms up and was surrendering in order to screw the cops.

He made up other stories too. After they encountered Wilson Dorian claimed:

His left arm came out the window and he placed it directly on my friend's throat. Big Mike, he's angered but not so much as I want to touch you anger so much as I want to get away from you anger. So he's makin' his frown face 'cause he's angry. I understand his anger. And, I can tell he was grippin' him because I could see Wilson's muscles bulging. So I can see that he's applying pressure with his grab because I can see his forearms tightening and the officer's muscles are bulging a little.

Dorian must have had X-ray vision to see Wilson's muscles bulging through his shirt. The DOJ Report stated:

96. <http://www.dailymail.co.uk/news/article-2692234/Disgusting-Friends-relatives-New-Jersey-cop-killer-create-shrine-candles-liquor-bottles-commemorate-cold-blooded-killer.html>

Wilson and other witnesses stated that Brown then reached into the SUV through the open driver's window and punched and grabbed Wilson. This is corroborated by bruising on Wilson's jaw and scratches on his neck, the presence of Brown's DNA on Wilson's collar, shirt, and pants, and Wilson's DNA on Brown's palm. *While there are other individuals who stated that Wilson reached out of the SUV and grabbed Brown by the neck*, prosecutors could not credit their accounts because they were inconsistent with physical and forensic evidence, as detailed throughout this report.

There is one example of Dorian lying to the feds. Dorian, who became the leader of millions of African-Americans with his lies against the police, went on to say:

Yeah, I can see. Now, my friend Big Mike, like I said he never put anything in his pocket. His hands are filled with cigarillos. Big Mike can't get a good grasp on the vehicle so he could pull himself all the way back so now he's tryin' to maneuver his body to where the officer's grip was slipped and now Wilson's arm is not around my friend Big Mike's neck anymore. Now Wilson is more into grabbin' his shirt and his shoulder. Wilson never let go of Big Mike.

My friend Big Mike never reached in the car to grab the officer back. Because at that time the officer didn't try to open his door again. He did not try to get back out the vehicle. He was tryin' to pull Big Mike inside the car through the window. Big Mike is so big like he's literally a little over the window. So, it's not like his head is comin' in more than his chest.

THE NEW CROW JIM

He's tryin' to pull him in. So, he's pullin' away. He's pullin' him in and Big Mike has his hands filled with cigarillos so now he's turnin' tryin' to get away from the officer. The officer still hasn't let him go and he still hasn't tried to open his door again.

Now me, I'm standing in shock, 'cause I'm not a full inch away from anything. I'm still standing tight here watchin' the tug-a-war. I see the officer's face, angry. I see my friend Big Mike's face angry. I hear the words, my friend Big Mike sayin' "Get the fuck off me. We're not doin' anything wrong. Leave us the fuck alone." And, the officer, he's not so much saying anything anymore more than tryin' to detain Big Mike. It's like he's tryin' to pull 'em inside the window and my friends pullin' away. And, it was very strange and odd to me why they were still goin' on and the officer never tried to get back out of the vehicle.

The DOJ reported:

Wilson told prosecutors and investigators that he responded to Brown reaching into the SUV and punching him by withdrawing his gun because he could not access less lethal weapons while seated inside the SUV. Brown then grabbed the weapon and struggled with Wilson to gain control of it. Wilson fired, striking Brown in the hand.

Autopsy results and bullet trajectory, skin from Brown's palm on the outside of the SUV door as well as Brown's DNA on the inside of the driver's door corroborate Wilson's account that during the struggle, Brown used his right hand to grab and attempt to control Wilson's gun.

According to three autopsies, Brown sustained a close range gunshot wound to the fleshy portion of his right hand at the base of his right thumb. Soot from the muzzle of the gun found embedded in the tissue of this wound coupled with indicia of thermal change from the heat of the muzzle indicate that Brown's hand was within inches of the muzzle of Wilson's gun when it was fired.

The location of the recovered bullet in the side panel of the driver's door, just above Wilson's lap, also corroborates Wilson's account of the struggle over the gun and when the gun was fired, as do witness accounts that Wilson fired at least one shot from inside the SUV.

Dorian continued lying:

Mike and the officer they did have words. I could hear a Big Mike's words. He was using profanity. His tone was aggressive but he never once made a threat at the officer. He never once tried to pull the officer out of the vehicle like the officer's tryin' to pull him inside the vehicle. *He never once reached for the officer's weapon.* I saw vividly that the officer had his weapon drawn on us.

I didn't know what to do. At this time I grab all of the things out of Big Mike's hands, cigarillos he's now turned back towards the officer. The officer never let his grip go. He still had a hold on Big Mike now.

The whole time Big Mike's hands were filled, he couldn't get a grip on anything let alone the officer. Only thing he could do was use his strength to pull away.

THE NEW CROW JIM

He handed me the cigarillos and now they're face-to-face with each other and I'm standing right here with the cigarillos watching officer and my friend in a tug-a-war match 'cause it was not a wrestlin' match because he never got back out the car. He's sittin' down and we're standin' up. I never intervened. I never made a remark after he pulled back I was so much in shock I couldn't say anything. I could just stand and watch.

Dorian the jive assed liar was cross examined:

Det: Okay, now you're saying, you're saying his torso comes in the car, right? But you can imagine how hard it is for me to visualize that, right, I mean Mike's a big guy right? He's 300 pounds or so, right?

Dorian: Yeah. The officer is sitting down. So I don't really think he can overpower Mike standing up with one hand. He had to be super human to do something like that. His hand is on his throat like this. And, I told you I can see his muscles and his arms bulging so I could tell you he was gripping. But, because Mike's so big his hands is up on Mike's neck. So, now you get the vision of when I say torso I don't mean he had his body inside the window like this.

I mean, like he was tryin' to pull him but it wouldn't go, it wouldn't fit. Wilson had his arm. He turns back around but his hands don't go up because the officer now has one of his hands and the other hand is still pushin' off the vehicle 'cause he's tryin' to get away. So, he's tryin' to push off the vehicle even more so now.

But, his hand never went inside the car. His arm and hand never reached for the officer's weapon. Especially his free arm. And that's with the hand I think, if you know if they said he reached for a weapon, this would be the arm to do it with 'cause it's free. He doesn't have this one. This the free arm never went in the car.

The DOJ reported:

Some witnesses claim that Brown's arms were never inside the SUV. However, as discussed later in this report, those witness accounts could not be relied upon in a prosecution because credible witness accounts and physical and forensic evidence, i.e. Brown's DNA inside the SUV and on Wilson's shirt collar and the bullet trajectory and close-range gunshot wound to Brown's hand, establish that Brown's arms and/or torso were inside the SUV.⁹⁷

Wilson testified:

Brown placed his hands on the window frame of the driver's door, and again Wilson told Brown to "get back." To Wilson's surprise, Brown then leaned into the driver's window, so that his arms and upper torso were inside the SUV. Brown started assaulting Wilson, "swinging wildly."

Brown, still with cigarillos in his hand, turned around and handed the items to Dorian

97. http://www.justice.gov/sites/default/files/opa/press-releases/attachments/2015/03/04/doj_report_on_shooting_of_michael_brown_1.pdf

THE NEW CROW JIM

Johnson using his left hand, telling Dorian Johnson “take these.” Wilson used the opportunity to grab Brown’s right arm, but Brown used his left hand to twice punch Wilson’s jaw. As Brown assaulted Wilson, Wilson leaned back, blocking the blows with his forearms. Brown hit Wilson on the side of his face and grabbed his shirt, hands, and arms. Wilson feared that Brown’s blows could potentially render him unconscious, leaving him vulnerable to additional harm.

Consequently, while the assault was in progress and Brown was leaning in through the window with his arms, torso, and head inside the SUV, Wilson withdrew his gun and pointed it at Brown. Wilson warned Brown to stop or he was going to shoot him. Brown stated, “You are too much of a pussy to shoot,” and put his right hand over Wilson’s right hand, gaining control of the gun. Brown then maneuvered the gun so that it was pointed down at Wilson’s left hip.

Wilson explained that Brown’s size and strength, coupled with his standing position outside the SUV relative to Wilson’s seated position inside the SUV rendered Wilson completely vulnerable. Wilson stated that he feared Brown was going to shoot him because Brown had control of the gun. Wilson managed to use his left elbow to brace against the seat, gaining enough leverage to push the gun forward until it lined up with the driver’s door, just under the handle. Wilson explained that he twice pulled the trigger but the gun did not fire, most likely because Brown’s hand was preventing the gun from functioning properly.

Wilson pulled the trigger a third time and the gun fired into the door. Immediately, glass shattered because the window had been down, and Wilson noticed blood on his own hand. Wilson initially thought he had been cut by the glass. Brown appeared to be momentarily startled because he briefly backed up.

Wilson saw Brown put his hand down to his right hip, and initially assumed the bullet went through the door and struck Brown there. Wilson then described Brown becoming enraged, and that Brown "looked like a demon." Brown then leaned into the driver's window so that his head and arms were inside the SUV and he assaulted Wilson again. Wilson explained that while blocking his face with his left hand, he tried to fire his gun with his right hand, but the gun jammed. Wilson lifted the gun, without looking, and used both hands to manually clear the gun while also trying to shield himself.

He then successfully fired another shot, holding the gun in his right hand. According to Wilson, he could not see where he shot, but did not think that he struck Brown because he saw "smoke" outside the window, seemingly from the ground, indicating to him a point of impact that was farther away.

Dorian has a different version of events:

I heard the officer say, "I'll shoot." I looked into the window again because at that time I was just staring at Big Mike seeing if the officer was going to pull off of him or was he gonna let my friend go and try to get out the car again or anything. Now once he says "I'll shoot", *I've been shot before. They never took the*

THE NEW CROW JIM

bullet out. I'm very shell shocked. So my attention immediately went back on the officer. It definitely was a barrel of a gun that I was staring down. I'm littler than Big Mike so it's not in his face so much as it is in my face so I can see what he has in his hand, what the officer was holding in his hand. The officer pulled his weapon out and he said for the second time, "I'll shoot you."

At that time, the gun went off for the first shot. Big Mike was not inside the vehicle like he never got Big Mike down to the point where his whole top half of his body was inside the window. The officer's still hold his left, with his arm, and now with his right hand he's pointing a weapon at us or Big Mike and the gun go off.

When the gun goes off, it frightened me. I didn't run as soon as the gun go off so much as stepped and inched over from the open window because now I'm standing at the rear driver door.

I can tell everyone's in shock because the tug-a-war stopped. When I looked at my friend, I see blood splatter under his right, don't know where he was initially hit, but I definitely know he was hit with the first shot because I instantly see blood on his White shirt.

And that was the time Wilson let my friend go and that's why we were both able to run at the same time. It's not like I ran then he ran. After the first shot, we both ran at the same time.

We were runnin' more than a minute and some seconds or no not, I don't wanna say a minute, let's clarify that, seconds. Now, I watched my friend Big

Mike, he's passed the second car like I said and that's when I heard the officer get out of his. As he's runnin' passed the third car, the officer behind him, pointed his weapon with his weapon drawn and *he fired a second shot that did strike my friend Big Mike in his back 'cause that's when he stopped runnin'.*

Once the officer fired the second shot at Big Mike I knew he was struck because he instantly stopped in his tracks. *He stopped running. His hands were in the air before he turned around then he turned around now the officer slowed down but he's still pursuing.* He's not at a fast pace anymore so much now that they're face-to-face with each other. ***And, Big Mike's hands are in the air already.***

At the time of the second shot, like I said, my friend ***Big Mike put his hands in the air.*** He turns around to face the officer and now the officer is face-to-face with Big Mike with his gun still drawn. His gun never went back to his holster after the first shot. Big Mike started to say, "I'm unarmed" or "I don't have a gun" 'cause where I am located I'm still standing watchin'. I'm standing now because I see that the cop, his attention was not on me anymore. Almost like he didn't even see me when he walked directly passed me with his gun out.

Now, Big Mike came the same direction and he was able to see me. I was watchin' my surroundings because when they pulled off, I instantly turned back towards Big Mike and the cop 'cause I heard the second shot and I was watchin' the second shot hit him and I'm watchin' as he turns around the officer's face-to-face with him now and he goes to tell the officer that he's unarmed or he does not have a gun.

THE NEW CROW JIM

I couldn't hear him verbatim from where I was standing but I know he tried to talk to the officer and he tried to get out a second sentence but before he could fully get out the sentence, the officer fired several more shots. I heard more than four shots fired. My friend went all the way down in the fetal position. I'm still standing. He went all the way down in the fetal position. I watched him take several more shots. I watched Big Mike's facial expression. I could no longer see the officer's face. I could see the back of him. I could see Big Mike's front.

So, I see that he's taken shots. I see the pain in his face. He cannot say nothing, he's not screamin' 'cause I feel like he's still in shock because each time, each time he's shot, he's tryin' to get another word out until the fatal shot which, I don't know what made him stop moving, but he stopped moving and he was on the ground. This whole time I have the cigarillos. I had no pockets. I didn't drop not one pack of cigarillos like when the shots were goin' off my hands were clinch in' tighter.

According to Dorian, Wilson grabbed Brown by the torso, neck and arm through the window while Wilson was still seated in his SUV patrol car. When he couldn't choke Big Mike to death he shot him. As Brown walked away Wilson got out of the car and shot him again this time in the back, then again when he turned around with his hands up in the air to surrender and finally when he was already on the ground. Bam Bam Bam.

None of this matched the forensic analysis and it was obvious Dorian was lying to the Feds yet he was never charged. Dorian claimed to be a role model for Big Mike. He said he had a job, a baby and a baby mom. How come he wasn't working on that faithful day?

In reality Dorian was dealing drugs, mostly crack and “wax” an enhanced form of marijuana. Dorian was asked: “How do you know that it hit him in his back?”

If it would've missed him, or if he wouldn't have felt it, I believe he would've kept runnin'. He was not that far away from his home. If the bullet wouldn't have hit him if he seemed like he wasn't further more in danger, I believe he would have continued to run. *This is gonna sound weird. You don't know for a fact. You're, 'cause you're playin' a lot of assumption. You're playin' on what you know, what you would do, what Mike would do. But you know there was a shot.*

Dorian is covering his ass by just assuming Big Mike was shot in the back, he did not know that for a fact. He only assumed he was. He had to say this if the simplest of forensics (entrance wound versus exit wound) indicated he was lying to the Feds. The DOJ continued:

The autopsy results confirm that ***Wilson did not shoot Brown in the back as he was running away*** because there were no entrance wounds to Brown's back. The autopsy results alone do not indicate the direction Brown was facing when he received two wounds to his right arm, given the mobility of the arm. However, as detailed later in this report, there are no witness accounts that could be relied upon in a prosecution to prove that Wilson shot at Brown as he was running away.

Witnesses who say so cannot be relied upon in a prosecution because they have given accounts that

THE NEW CROW JIM

are inconsistent with the physical and forensic evidence or are significantly inconsistent with their own prior statements made throughout the investigation.

Dorian:

Once the officer fired the second shot at my friend Big Mike I knew he was struck because he instantly stopped in his tracks. He stopped running. ***His hands were in the air before he turned around then he turned around now.*** The officer has slowed down but he's still pursuing. He's not at a fast pace anymore so much now that they're face-to-face with each other. ***And, Big Mike's hands are in the air already.*** But let me rephrase because he was hit so he could not fully extend one of his arms. At that time, I'm in shock so, I'm not really lookin' for detail at which arm was lower than the other. I'm not sure. But, I knew for sure I saw both of his hands up. Both his hands were above his head. Now, which arm was above I, ya know.

The DOJ reported:

Those witness accounts stating that Brown never moved back toward Wilson could not be relied upon in a prosecution because their accounts cannot be reconciled with the DNA bloodstain evidence and other credible witness accounts.

There were two construction workers who at first backed up Dorian's "hand's up" lie but changed their tune under oath. As stated, according to the Bureau of Justice Statistics, one in three African-American men can expect to go to prison in their lifetime so anyone with a beef with the cops could use this opportunity to try to discredit them.

There were several honest African-American witnesses that backed up Wilson's story but remained anonymous least they be attacked by their other Blacks for not following the laws of the hood – no snitching on brothers. What is amazing is how the hands up gesture, which never existed, were bought hook line and sinker by the media and the Left. Now it has become a symbol of police brutality when in reality it is symbol of the all pervasiveness of a Black criminal subculture.



Dorian Johnson was arrested in May 2015 for resisting arrest and interfering with police as they attempted to arrest his brother, Demonte, on an assault charge.

The Justice Department should look into Dorian's lying to federal agents but won't because Obama stood behind Michael Brown. Brown's death was just an excuse to riot and fight the police – in the post DOJ report world, in retrospect, the rioters were demanding the right to beat up and shoot police officers. What the Brown case shows is that African-Americans have a blind hatred for Whites in America. The Public Religious Research Institute Poll determined that 75% of White people have no African-American friends. Differing attitudes toward crime account for this separation. If American's don't want African-American friends then why do we have the hands up crowd in the White House?

THE NEW CROW JIM

Holder and Obama pressured the Governor of Missouri to restrain the National Guard and many African-American owned businesses were destroyed by looters and assorted scum. This looting and rioting and wilding had nothing to do with the death of an African-American teenager.

If it did there would be demonstrations in every city where African-Americans inhabit because murder is rampant. What's the difference between a Black shot by a White cop and a Black shot by another Black? They are both dead. Infants are caught in the cross fire but this doesn't faze the Black community. Only when a White police officer is involved do they get violent. Cops interfere with the Black criminal subculture by enforcing the law and putting people in jail or prison or in their graves so this is only to be expected.



By taking the side of a Black thug who tried to brutally beat to death then murder a police officer Obama opened up a Pandora's Box of atavistic behavior already manifesting itself in the Black Criminal Subculture. It justified the Ferguson riots and legitimized the worship of an evil dumb thug who tried to kill a cop.

It led to hammer attacks on a Bosnian in Saint Louis by Blacks yelling kill Whitey.⁹⁸ It led to riots in Berkeley, Missouri, when a Black teen was shot after he pointed a pistol at police during an attempted gas station robbery.⁹⁹ It led to Baltimore. No telling what it will lead to in the future. As for Darren Wilson he is a virtual prisoner due to threats on his life and no police force will hire him.

He claims that even if you give jobs to Blacks they would prefer to deal dope. “You can lead a horse to water but you can’t make him drink.” The outcome: you have a bitter ex-cop and mob rule ultimately triumphed.

On the one year anniversary of Big Mike’s death gunfire began to ring out as rival groups began shooting at each other. The St. Louis County Police said that Trevion Hopson, a 17-year-old, was arrested after firing on a protest crowd on West Florissant Avenue. Hopson was being held and a 22-year-old man was found injured with a gunshot wound to his arm. Nearby, a man was shot and critically injured by police after he opened fire on officers in an unmarked vehicle. A stolen gun was recovered. Early the next morning, a 17-year-old and a 19-year-old were walking on a sidewalk near the Michael Brown memorial when they were shot at from an unknown car. The 17-year-old victim suffered gunshot wounds to the chest and shoulder and the 19-year-old suffered a gunshot wound to the chest, police said. They were both hospitalized with non-life-threatening injuries.¹⁰⁰

98. <http://www.dailymail.co.uk/news/article-2855535/St-Louis-teens-beat-motorist-32-death-hammers-sparking-protests-Bosnian-community.html>

99. <http://www.cnn.com/2014/12/24/justice/missouri-officer-involved-shooting/>

100. <http://www.nytimes.com/2015/08/11/us/photos-and-video-show-protests-in-ferguson-turning-violent.html>

THE NEW CROW JIM

Missouri State Senator Maria Chappelle-Nadal, who has blamed “White privilege” for the failures of Blacks and believed Michael Brown was a hero, said she has been reflecting since nine-year-old Jamyla Bolden was shot while doing her homework at home in Ferguson. “It’s okay to protest against police brutality, but it is also okay and admirable to fight for children’s lives, especially when they are taken far too soon,” Chappelle-Nadal said. “Too soon” before the usual time or the time expected; “she graduated early”; “the house was completed ahead of time” That means if their lives are taken later on in life it is okay? You think that a racist moron like Chappelle-Nadal would have been elected to the Missouri State Senate before America entered the New Reconstruction Era? It is another part of the legacy of the first hip hop president.

As for Jamyla, 21-year-old De’Eris Brown has been charged in the shooting death of Bolden after allegedly confessing he shot into her home. Brown was arrested in February 17, 2014 after pulling a pistol on his 18 year old ex, a Subway employee, in the middle of the parking lot. Brown called her said “I’m coming up to your job and going to shoot up the place; you better leave.” You would think his ex would call the police and they would be waiting for him but she didn’t. Instead she ran into the parking lot leaving the other employees to take the bullets. When Brown arrived at the shop at about 8:30 p.m. he threatened her while he was on the parking lot. Brown removed a pistol from his waistband, racking the slide back and yelling “Come talk to my nine,” police said referring to his millimeter handgun. He later grabbed the back of the woman’s neck and pushed her, according to court documents. Brown, 20, was charged with unlawful use of a weapon and misdemeanor assault. Bail was set at \$75,000 cash only.¹⁰¹

101. <http://www.realtimestl.com/21099>

A. J. WEBERMAN

Charges in the incident were later dismissed because prosecutors said the victim did not cooperate.

If the victim did not cooperate the state could have filed the charges and forced her to cooperate. There must have been witnesses in the parking lot. They caught him with the gun. Something is wrong here. Dulany Harms handled the case.



In March 2014, Brown pleaded guilty to robbery charges and was sentenced to 10 years in prison, but the sentence was suspended by Judge Ted House and he was placed on five years' probation.

Defendant sentenced on both counts to 10 years suspended (5 years) probation (Missouri probation & parole); restitution in the approximate amount of \$500.00 to e.b. and j.w.; no contact with victims e.b. and j.w.; no contact with co-defendant Myers; pay court costs, so ordered. Judge Ted House.

THE NEW CROW JIM

Judge Ted House is the President of the Missouri Circuit Judges Association. The organization represents 144 judges statewide. House, 52, served 14 years in the Missouri Legislature as a Democrat. He is a graduate of Central Methodist University in Fayette and the University of Missouri-Kansas City law school.

Judge House is known for his walks: A 25-year-old Wentzville African-American woman who drank and did drugs while her 10-week-old son suffocated will serve no jail time thanks to Judge House. Jordan Danielle Glenn pleaded guilty to one count of endangering the welfare of a child. Maurice House, the baby's father, faces the same charge; his case is set for trial in September 2015. The baby, Amauri House, died. Circuit Judge Ted House gave Glenn a suspended seven-year sentence.¹⁰²

On October 2, 2009 Rodney L. Pitts, 37 pleaded guilty of two counts of statutory sodomy, one count of child molestation and one count of sexual misconduct. He admitted having sexual contact with the girl several times between 2006 and 2009. In exchange for his guilty plea, prosecutors agreed to recommend a 10-year sentence and not to argue against probation. Circuit Judge Ted House followed the terms of the plea agreement in sentencing Pitts to concurrent terms of 10 years on the sodomy and molestation counts and four years on the sexual misconduct count. Based on written victim's impact statements, he suspended the sentence and placed Pitts on probation for five years.¹⁰³ Rodney L Pitts of Little Rock, Arkansas was arrested on September 29, 2010 Booking

102. <http://fox2now.com/2015/03/06/woman-gets-suspended-sentence-in-death-of-infant-son/>

103. <http://www.pctattletale.com/blog/467/judge-ted-house-soft-on-child-sex-offenders/>

Charges Sexual Solicitation of a Child.¹⁰⁴ March 3, 2015 a level-three sex offender is moving into Pope County, deputies say Rodney L. Pitts, 57, is moving into the 800 block of County Road 1794 in London, according to the Johnson County Sheriff's Office.

He is unemployed. Pitts paroled out of prison on Feb. 25, 2015 according to prison records. He was convicted of sexual solicitation and indecency with a child. Authorities say he exposed himself to a 4-year-old girl.¹⁰⁵

Steven Jon Martineau, 48, pleaded no contest to charges of involuntary manslaughter and two counts of domestic assault in the death of Linda Cerutti, 50. While he did not admit guilt under the plea, he agreed prosecutors had enough evidence for a judge or jury to find him guilty. Although House gave him a 20-year sentence one year shy of the maximum that could have been imposed for the charges, Martineau could be eligible for parole after six years.¹⁰⁶

104. <http://www.mugshotsonline.com/arkansas/little-rock/rodney-l-pitts/153835111>

105. <http://5newsonline.com/2015/03/03/level-three-sex-offender-moving-into-pope-county/>

106. <https://www.questia.com/newspaper/1P2-34584176/man-gets-20-years-for-fatally-beating-girlfriend>

CHAPTER EIGHT

TAMIR RICE: MARTYR BLACK LIVES MATTER



Another cause celeb of the New Reconstruction Era was Tamir Rice. Tamir Rice aimed an altered replica gun at passerby's and was shot by Cleveland Ohio police when he pulled it on them. The police didn't want to take any chances in case it was real. However the Officer who killed Tamir was eventually fired due to pressure exerted by the crime-ridden African-American community.

It was claimed he falsified his initial application. The facts of this case indicated the shooting of this miscreant was justified.

Tamir's mother was a crack dealer with a long criminal record¹⁰⁷ and you can bet that his spring loaded BB gun would have eventually been replaced by a real one. Do Americans believe in order to prove the gun was real the cops should have taken a few rounds before returning fire? Are they the sacrificial lambs for racism? Tamir was twelve years old but looked much older and was a gang member or wannabe.

Leonard Warner, who fathered the 12-year-old has multiple convictions for the abuse of women. In November 2015 Warner, 34, requested a continuance in his latest domestic violence case moving through Cuyahoga County Common Pleas Court.¹⁰⁸ He is accused of punching his live-in girlfriend in the head and arms according to a police record. The victim's name was redacted. Warner is estranged from Rice's mother Samaria Rice, who pleaded guilty to drug trafficking in 2013 and assault in 2001. The same year, on Dec. 8, 2001, she was the victim of domestic violence. Warner was her knife-wielding attacker according to a court document.

107.

http://www.cleveland.com/metro/index.ssf/2014/11/lawyer_representing_tamir_rice.html

108.

http://www.cleveland.com/metro/index.ssf/2014/11/tamir_rices_father_has_history.html

THE NEW CROW JIM



The report does not say if Rice was injured. Warner was convicted in the case and sentenced to one year of probation. The court noted that Warner had a prior domestic violence conviction in Euclid Municipal Court. In 2010, Warner was arrested again for domestic violence. He pleaded guilty and was sentenced to two years probation. Samaria Rice was the victim in that case. Even though their relationship ended, Samaria Rice again found herself the victim of male violence. She called Strongsville, Ohio police twice in 2010 to report abuse from a boyfriend. In one case, she told police that her live-in boyfriend, Michael Wiley, of Cleveland, had beaten her for two days. Wiley was convicted of domestic violence and given a suspended 90-day jail sentence, county court records show. Judges in Cleveland look at domestic violence as a part of Black criminal subculture and hand out lenient sentences as they believe this sort of behavior can only be expected from African-Americans since it is ingrained in their culture.



The Cuyahoga County Sheriff's Department¹⁰⁹ released this report:

On this date investigators had the occasion to interview Devin Mims in the presence of his mother, his grandmother and his attorney at the Cleveland offices of The Alcohol Tobacco and Firearms.

Detectives had previously discovered an audio recorded interview conducted by a WKSU reporter of Devin Mims on November 23, 2014. During this interview Devin Mims explained how he was responsible for providing Tamir Rice the BB gun and how the entire situation was his fault. The following is a synopsis of the video recorded interview provided to members of the Cuyahoga County Sheriff's Department.

109. <https://www.scribd.com/doc/268843357/Cuyahoga-County-Prosecutors-Office-Tamir-Rice>

THE NEW CROW JIM

Devin Mims recalled on November 22, 2014 he and his cousin met Rice and his sister about 10:30 AM and walked over to the Cudell Recreation Center.

Devin Mims stated that Rice asked to see his toy BB gun; In exchange. Devin Mims received a cellular telephone from Rice to access the internet. Devin Mims explained that he was wearing a long sleeve Red shirt and carrying Black backpack on that day.

Devin Mims stated that his father purchased the BB gun from an unknown Walmart location in the Cleveland area; Devin Mims stated that he had the BB gun for a long time. The BB gun magazine had a capacity of 12 BB's and the gun was spring activated. Devin Mims stated that one day the gun had malfunctioned and he attempted to fix it. He disassembled the gun discovered the problem, fixed the problem and when he reassembled the gun he was unable to get the "Orange tip" back on the gun.

I doubt Devin had the skill to fix the gun. What really happened was Devin removed the orange tip from the gun to make it look more real.

Devin Mims continued, stating that after Rice received the gun he began playing with it then put the gun in his pocket before they all went inside of the recreation center. He stated that Rice had received a telephone call and that soon after that call Devin Mims and Rice left together and went back home after the telephone call.

He stated that Rice was supposed to give the gun back to him later on that day.

Devin Mims stated that later in the day he texted Rice and did not get an answer, and then texted

(deleted) to let her know that he was going to come back to the Cudell Recreation Center. He stated that he then went to McDonald's on W. 105th St., then headed back to the Cudell Recreation Center after he had heard that Rice had been shot.

Devin Mims stated that Rice had owned a Black LG cellular telephone: that he either found or his mother had given to him. He stated that he communicated with Rice through various social media websites that they were able to access through a Wi-Fi connection. They communicated through KIK and Facebook.

He probably found it? Where? In someone's pocket or purse?

Devin Mims stated that Rice has borrowed the gun from him on several occasions and has even kept his BB gun overnight in the past. Devin Mims stated that Rice had problems in the past with kids pickin on him (Deleted)

At two hundred pounds of blubber Tamir was probably picking on the other kids. Or maybe he needed a realistic looking piece to intimidate older kids who were picking on him? Devin was shown surveillance videos: Devin Mims pointed out Himself Rice walking to the recreation center. Mims showed investigators Rice placing the gun back into his backpack. (11:04) Mims and Rice enter the Recreation Center.

(11:06) Mims states that once in the Recreation Center they go to the game room. Rice and Devin Mims appear outside of the recreation center doors. Rice takes the gun back and places it in his outer jacket pocket.

THE NEW CROW JIM

Devin Mims tells Rice that someone could mistake that for a real gun. Rice then puts the gun in his back pocket. (12:21) Rice gives the gun back to Devin Mims comes into the video and is with Rice, and himself (12:30) Devin Mims states that Rice has the gun now. (1:04) Devin Mims gives the gun back to Rice who then puts the gun in his back pocket. Devin Mims and Rice are in the video, Rice is shooting BB's at (Deleted) Rice was pointing the gun at his friend and he was shooting the gun at (Deleted) but the BB's were hitting Devin Mims Devin Mims stated that Tamir was showing us how the BB's curved. Devin Mims stated that Rice headed home to eat lunch or do chores. (1:06) The police interviewed another one of Tamir's homeboys:

(Deleted) stated that he attends Almira Elementary School and that he has known Tamir Rice for about one year.

He stated that he met Rice through his friend Devin Mims at The Cudell Recreation Center and only knows him from there. He has never met Rice's mother and has never been to his home. He stated that Rice usually comes to the recreation center with his sister and will play basketball and ping pong. On that day (Deleted) stated that he and Devin Mims were shooting at the tires of cars with the BB gun. (Deleted) confessed that before he and went into the recreation center that he too shot the gun with Rice. (Deleted) were at the park and Rice and another boy were (Deleted).

He stated that he and Devin Mims had arrived at the recreation center around 1:00 pm (possibly) that day, met with Rice and shortly after meeting with him they left to go into the recreation center because (deleted) had gotten into trouble at a Save-A-Lot store with a fake gun in the past. (Deleted)

stated that Rice was pulling the gun in and out of his pants "Like a robber would do." (Deleted) stated that when he and Devin Mims were in the back of the recreation center they heard, what he thought was fireworks, but believed that they were gunshots. He and Devin Mims then went towards where they thought the sounds had come from and that's when they saw the police at the gazebo.

(Deleted) stated that he didn't want to be around Rice after that because he had the BB gun. (Deleted) explained that 3 to 4 months earlier he was involved in a similar incident with a BB gun. He stated that he had a BB gun and had pulled it out while inside of a Save-A-Lot store. He stated that someone must have called the police because he was eventually approached by a policeman inside of the store and was told to put his hands up. He was asked if he had a gun, and while his hands were in the air he told the officer, "yes." The officer then took the gun from him. He stated that he learned a lesson from that incident because he got into trouble.

Tamir ran with a crew that was into pulling off holdups with toy guns. Now we come to the interview with the man who dropped a dime on Tamir:

(Deleted) stated that shortly after he had arrived at the park, he sat down in the gazebo and noticed an "older looking" Black male who was walking from the recreation center. This male, later identified as Tamir Rice, walked on the sidewalk in front of him but closer to the parking lot. He stated that the male was acting "Gangster" by pulling a gun in and out of his waistband and pointing it straight out in front of him then returning the gun back to his waistband.

THE NEW CROW JIM

He stated that this male repeated this same motion at least six to seven times. (Deleted) stated that he had been a victim of a previous assault in 2012, because of this he became frightened by these actions and refused to make eye contact with this male fearing that he would approach him. (Deleted) recalled that at one point this male had even pulled out the gun on a passerby, pointing the gun directly in the woman's face as she walked by him on the sidewalk. He stated that the male also appeared to be saying something on occasion when he pulled out the gun, but - informed investigators that he did not have his hearing aid and could not clearly determine what the male was saying. (Deleted) stated that when the male walked back toward the recreation center and away from him, he took out his cellular telephone to place a call to the 911 dispatcher. Either during or just before the 911 call, (Deleted) stated that male walked back towards him, walked past him on the sidewalk and sat on the swing located in the park. He stated that because he had his "Hoodie" up over his head, he was trying to conceal the fact that he was on the telephone from the male. He stated that at one point he was afraid that he may be shot in the back if had gotten up and walked toward the transit station.

Tamir looked threatening and was freaking this passerby out. You bet he wasn't say "Good day ma'm" to the women he was terrorizing with his modified replica weapon.

At this point investigators played a copy of the original **911 call** which (deleted) had placed to Cleveland Police Dispatch. During this call (deleted) clearly stated to the dispatcher that the gun was "probably fake" and that the male was probably a

A. J. WEBERMAN

juvenile. When asked why he mentioned this to the dispatcher; he stated that he didn't know if the gun was fake or not, nor did he know if the male was a juvenile. When asked why earlier in the interview he mentioned that he believed that the male was 20 years of age; he stated that the male was a big boy and didn't know that he was only 12 years of age, but because of his size he looked much older.

Cleveland Police Hollinger.

Hey how are you?

Good.

I am sitting in the park at West Blvd by the West Blvd Rapid Transit station and there is **a guy** here with a pistol; it is probably fake but he is like pointing at everybody. I am sitting in the park at West Cudell by the West Blvd rapid transit station.

Are you at the rapid station?

I am sitting across the street at the park. Cudell Park. **The guy** keeps pulling in and out of his pants. It is probably fake but you know what he is scaring the shit out of me. He has a camouflage hat on.

Is he Black or White?

He has a gray coat with Black sleeves and gray pants.

Is he Black or White?

He is Black. He has a camouflage hat on and his jacket is gray and he has Black sleeves on it. He is

THE NEW CROW JIM

sitting on the swing right now but he is pulling it in and out of his pants and pointing at people. ***He is probably a juvenile you know.***

Do you know the guy?

No I do not. I am getting ready to leave but you know what he is real nearby the youth center he pulling it in an out of his pants. I don't know if it's real or not.

Okay we'll send a car there. Thank you.

Code one: If anyone could break at Cudell. In the park by the youth center there is supposed to be a male sitting on the swings pulling a gun out of his pants and pointing it at people. He is wearing a camouflage hat gray jacket with Black sleeves He is .pulling a gun out of his pants and pointing it at people.

HOLLINGER refused (per her attorney) to answer a question about why she did not relay information from the "911" caller about the person with the gun is "probably fake" and "probably a juvenile." The "911" caller also stated "/ don't know if it's real or not." HOLLINGER once again (per her attorney) refused to answer those questions.

The dispatcher failed to pass along the caller's contention that the gun was probably a fake and that "the guy" a juvenile.

Why? In a case like this you have to go on the assumption that the gun is real and not cause the police who are answering the call to lower their guard by telling them it might be a toy gun.

Witnesses to the Tamir Rice shooting were determined to frame the police.

(Deleted) stated that about 30 minutes later her friend had arrived to pick her up to take her to the store. She stated that when she walked outside and was about to enter the passenger side door of the vehicle, she heard three gunshots and some yelling. Specifically- described hearing two gunshots "Bang Bang" then hearing someone yell, "Freeze! Show me your hands!" then she heard a third and final "Bang."

Only two shots were fired that day. The surveillance video indicates that the moment Tamir saw the police the 12 year old thug put his hand into his waistband as if he was going to pull out a gun and fire it. This was a like a Western movie where two men face off and one of them yells "draw." Once someone draws a gun and points it in your direction yelling "freeze" would be pointless and distracting and might cause you to lose the gunfight. This is what the surveillance video showed:

15:27:37 - Tamir sits at the northeastern most picnic table inside the gazebo. Should be noted there are three (3) tables inside gazebo #1.

15:30:13 - Tamir stands up and walks northwest toward the edge of the gazebo.

15:30:23 - CPD marked unit 115A arrives, ***Tamir reaches in his right waistband. Patrolman Timothy Loehmann exits the passenger side, draws and appears to point his firearm in the direction of Tamir. Loehmann retreats backwards and stumbles and falls continuing to point his weapon in the direction of Tamir. Loehmann takes cover at the rear of his vehicle.***

15:30:27- Patrolman Frank Garmback exits 115A drivers' side.

THE NEW CROW JIM

15:31:00- Garmback approaches Tamir and appears to kick something with his left foot in a westerly direction.

15:31:45- Garmback extends his arms toward Im as she enters the camera from the north. This causes him to fall down.

15:31:49- Garmback takes (deleted) to the ground.

15:31:53- Loehmann assists with him as Garmback turns his attention to Tamir.

15:31:59- Patrolman William Cunningham enters the view from the north and assists Loehmann.

Other witness also tried to frame the police.

Further, (deleted) wrote in her blog that Tamir Rice and his friends were at the Regional Transit Authority (RTA) station across the street and that a White man must have seen the gun and called the police. The kids then ran back to the park and they were sitting together when the police arrived. She stated, "The police pulled their guns on the kids, Rice's friends backed away and told the officers that it was a BB gun w/no bullets and he went to lift up his shirt to show it to them, they shot him twice in the stomach. In front of not only his friends, but also other children and I believe his sister as well.

TAMIR RICE WAS MENTALLY DISTURBED

Tamir was demented and got his kicks by terrorizing random passerbies:

13:03:52- Tamir holding Replica Firearm, (Deleted) and Unknown Male #1 (UM) walking on sidewalk southbound. Tamir places Replica Firearm to UM's head.

13:06:34- Tamir pointing Replica Firearm at UM and (Deleted) as they exit view of camera.

(Deleted) stated that she has been employed as a teacher with the Cleveland Metropolitan School District since 1992. She stated that she is currently an Art teacher at Marion-Seltzer Elementary School and was the Art Teacher for Tamir Rice. (Deleted) explained that Marion Seltzer is a kindergarten through 8th Grade school and that ***Rice was a sixth grader in the Special Education Program. (Deleted) explained that this program was for the emotionally disturbed children and that the class size was not larger than 10 children but Rice's class only had 6 children.***

Tamir Rice was not an emotionally disturbed child, he was a mental case. This combined with his size made him dangerous, even to the other mental cases in his class.

(Deleted) stated that she began teaching Rice at the beginning of the 2014 school year and stated that he loved Art and that she never had a problem with him at school. She stated that about a week prior to the incident at Cudell Recreation Center Rice had been involved in an altercation at school with a boy identified as Ashanti Jones but didn't know much about the incident.

More insight was shed into Tamir Rice's real personality by one of his friends whose name has been deleted.

THE NEW CROW JIM

(Deleted) was asked if he could remember where Rice had kept the gun; he stated that Rice kept the gun in inside his waistband on his left side with the barrel pointed downward and he had to lift up his jacket to pull it out when he was with him. (Deleted) stated that Rice told him that day that *his mother bought the gun for him and that he had seven more BB guns at home*. He stated that he never believed Rice when he said that statement. (Deleted) believed that Rice was saying those things because he wanted to be cool. Further, (Deleted) believed that Rice had the gun that day because wanted to appear "Cool" and this is why he was showing off the BB gun. (Deleted) stated that as long as he had known Rice he had never seen him with a gun before that day.

During the playback of the video (Deleted) stated that he didn't know the two males that walked up to everyone by the rear door of the gymnasium however (Deleted) believes that two of the unidentified males are members of the BBE-900 gang.

When questioned if Rice had any involvement in that gang; (Deleted) stated that Rice has told him in the past that he "Rolled with" BBE-9100, but again (Deleted) stated that he thought Rice was also lying about that because he just wasn't the type of person to be involved in a gang. (Deleted) stated that a lot of people at CRC claim to be in BBE-99 but they really are not in the gang.

Cleveland gangs used youth centers as meeting places: The Cutthroat gang, an affiliate of the Heartless Felon gang, met at Cory Recreation center to plan robberies and drug sales, Cleveland police

and the Cuyahoga County Prosecutor's Office said. What about BBE 900, the gang Rice claimed to be affiliated with?

In late October 2014 prosecutors from the Juvenile and Adult Criminal Units prepared and submitted for filing 299 charges, including juvenile complaints and a Grand Jury indictment against 38 members of the BBE 900 gang.¹¹⁰ The BBE 900 juvenile gang members range in age from 13 to 17. In total, prosecutors charged 26 juveniles and 12 adults. This group of thugs engaged in a continuous torrent of aggressive, brazen and violent acts. They include assaults, break-ins, robberies, burglaries, kidnappings, shootings and murder. Prosecutors say they have committed many of the acts in public places, including city parks and RTA transit stations. They savagely beat one of their victims in the middle of a busy street, prosecutors said. They have tagged public and private property with their graffiti.

Tamir could have passed for 20 and might have been a member of the BBE 900 gang. It was unlikely that they would ask him to produce ID before making him a member. Tamir already had a girlfriend. Note this police radio transcription:

At time stamp 4:14 a male voice can be heard "Radio um shots fired. Male down, um **Black male maybe 20, um Black revolver** (inaudible) send EMS this way and a road boss."

Mandi asked if they were at Cudell and at time stamp 4:46 the male voice "yes ma'am at Cudell, he has a gunshot wound in the abdomen." Mandi said at this time she phoned across the dispatch center to EMS.

110.

http://www.cleveland.com/court-justice/index.ssf/2014/10/police_arrest_38_members_of_we.html

THE NEW CROW JIM

There were sixty shootings in Chicago during July 4, 2014 weekend. A six year old was killed. Six is half of twelve.



TAMIR'S TOY GUN LOOKS REAL TO THIS RESEARCHER

CHAPTER NINE

THE COP KILLING LOBBY



Cop Killing Lobbyists come from all walks of life. In July 2009 Sgt. James Crowley responded to a call of a possible break-in at a Cambridge, Massachusetts home. The woman saw two Blacks trying to force their way into a private house. In reality, the person a neighbor thought might be a burglar was the homeowner, Harvard professor Henry Louis Gates, with his driver helping him enter the house. Should the neighbor have told herself that it would be racist if she called the police because the men were African-Americans and should she have not dialed 911?

When Sgt. Crowley arrived at the home, he asked Professor Gates for ID. Gates copped an attitude “Why? Because I’m a Black man in America.” Gates initially refused to produce an ID. Once he did, the police report indicates Crowley left the home.

THE NEW CROW JIM

However, Professor Gates followed him outside and continued to “scream” at Sgt. Crowley. Crowley claims to have warned Gates in front of several neighborhood witnesses before arresting Gates for disorderly conduct. Gates wanted to get arrested in order to prove his point that the cops in America are racist and so he staged a deliberate provocation. Gates later claimed the arresting officer was a racist who simply couldn’t believe that a Black man lived in a high-priced, Harvard-adjacent neighborhood. But Crowley had no history of bad behavior of any kind and numerous African-American officers on the force came to his defense. During a press conference Obama was asked:

"Recently, Professor Henry Louis Gates, Jr. was arrested at his home in Cambridge. What does that incident say to you? And what does it say about race relations in America?" Obama replied,

Now, I've – I don't know, not having been there and not seeing all the facts, what role race played in that. But I think it's fair to say, number one, any of us would be pretty angry; number two, that ***the Cambridge police acted stupidly in arresting somebody when there was already proof that they were in their own home.*** And number three, what I think we know separate and apart from this incident is that there is a long history in this country of African-Americans and Latinos being stopped by law enforcement disproportionately. That's just a fact.¹¹¹

Obama had no idea what transpired outside or inside Gate’s home but none-the-less he clearly came down on the side of the brother blaming racist cops for the incident. In a tribalistic society you defend the tribal member no matter what he does, in a civilized society you go by the rule of law. Obama had some bogus “happy

111. <http://www.nytimes.com/2009/07/23/us/politics/23gates.html>

hour” event between Gates and Crowley at the White House despite the fact that Gates had yelled at the officer in a disrespectful and threatening manner. How many times does an officer have to drink beer with someone he arrested? Obama was putting the alleged perpetrator and the policeman on the same moral plane. By hosting this event Obama was implying that Crowley should not have questioned Gates despite the neighbor’s report of an attempted break-in, because Gates was Black and this would have constituted racial profiling.

The fact Obama has a cop-hating street mentality became even more evident when he supported Michael Brown. As previously documented Brown was a dirt bag who attempted to kill a White police officer. By doing so the President of the United States legitimized the belief that the police in America are all White racists who get their kicks out of beating and shooting angelic Blacks for crimes such as jay walking & strong arm robbery. Obama even went to the Al Sharpton-like extreme – honoring Michael Brown’s parents by inviting them to the White House to console them for having lost a son who tried to kill a police officer.

By creating this toxic atmosphere from the top down President Obama encouraged the killing of cops. His slogan should be *cops lives don’t matter* because he, like so many other African-Americans, tried to frame Officer Darren Wilson. In the New Reconstruction Period there is no doubt that some of Obama’s constituency in Ferguson, Missouri, given the opportunity, would have thrown a necktie party for Officer Wilson.

The Justice Department report on Ferguson exonerated Officer Wilson and unequivocally stated that Michael Brown had tried to get Wilson’s gun and murder him, yet the demonstrations against the shooting of Brown “an unarmed” Black youth continued

THE NEW CROW JIM

These demonstrations were not about the killing of Michael Brown but were demonstrations to make killing police officers an entitlement. This is where the *The Cop Killing Lobbyists* come in.

According to the National Law Enforcement Officers Memorial Fund's report the number of law enforcement officers shot to death in the line of duty rose more than 50% in 2014 with more officers killed in ambushes. Fifty officers were killed by firearms -- 15 in ambush attacks -- in 2014. That's compared with 5 ambushes among 32 shooting deaths in 2013 and 6 ambush deaths during 2012, according to the FBI. In 2016, 60 officers were shot and killed -- including 20 in ambushes -- a 67 percent increase over 2015.

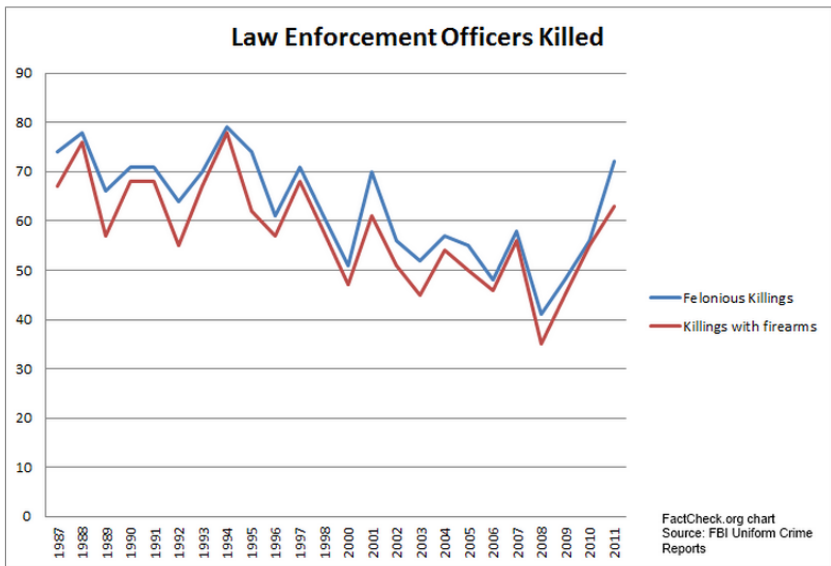

This is a direct result of the legal victories of *The Cop Killing Lobby* and because of the incitement created by the Black Ku Klux Klan sympathizers in the highest levels of American government.

The Cop Killing Lobby starts at the top. *The President of the United States, his former Attorney General and the head of Homeland Security* are all part of a cop-hating movement in America that makes statements, issues reports introduces legislation and proclaims executive orders that in effect endanger law enforcement officers and civilians and empower criminals. African-American elected officials and their liberal sympathizers in State, Local and Federal Government who introduce legislation such as ending stop-and-frisk are part of this lobby. These legislators become part of a system they believe is corrupt and often contribute to the corruption. They are aided by ultra-liberal Jewish Federal judges like **Shira A. Scheindlin** intent on weakening law enforcement. Scheindlin struck down the NYPD's stop-and-frisk policies in an opinion that portrayed NYPD as a bunch of racist pigs. The U.S. Court of Appeals for the 2nd Circuit not only stayed Scheindlin's order, but took the extraordinary step of removing this limousine liberal from any further involvement in the case.¹¹²

Non Governmental Organization (NGO's) masquerading as advocates of civil liberties is a big part of the lobby. This subsection is comprised of groups such as the ACLU, the National Lawyers Guild and the Center for Constitutional Rights. They run "lawfare" operations whose goal is to weaken law enforcement and strengthen the rights of criminals who they wish to use to overthrow what they believe to be a Capitalist, racist system where most of the wealth is concentrated in the hands of the few. Their motto should be "Criminals of the World Unite!"

NGO's like the Raise the Age coalition want to ameliorate the consequences of committing crime because they realize they can never destroy the Black Criminal Subculture. Their sympathy lies with the perpetrators and not with the victims.

112.

http://www.silive.com/opinion/danielleddy/index.ssf/2014/09/as_garner_grand_jury_convenes.html

THE NEW CROW JIM

This organization lobbies for rising the age of criminal irresponsibility from 16 to 18 despite the fact that gang members are recruited at progressively earlier ages. This will encourage 17 and 18 year olds to commit crimes knowing their cases will be transferred to Juvenile or Family Court where everyone gets a walk. Their organization is based on pseudo-science.

Research cited by the Raise the Age coalition shows that cognitive brain development is not complete until the age of 25. Members of the Raise the Age coalition argue that 16- and 17-year-olds are still children, and since they are still developing, they are highly receptive to positive character and behavioral changes.

Raise the Age points to the fact that African American youth make up 30% of those arrested while they only represent 17% of the overall youth population. At the other end of the system, African-American youth are 62% of the youth prosecuted in the adult criminal system and are nine times more likely than White youth to receive an adult prison sentence.¹¹³ Perhaps they commit more serious crimes more frequently than Whites? Raise the Age points to the case of Kalief Browder who was on probation for a criminal charge and couldn't make bail after he was caught stealing someone's knapsack. He was at the rock, Riker's Island, for three years before the charges were dismissed. At Riker's he attacked CO's and other prisoners so was sent to the hole for a good deal of his time. After he was released he was arrested again and ended up taking his own life. Of course he got a raw deal because the average time in jail is two months. His case was the exception not the rule.

Governor Cuomo, who supported Raise the Age stated "We did not reach an agreement on something called Raise the Age

113. <http://static.nicic.gov/Library/025555.pdf>

which is a proposal that I had made in the State of the State. The executive will on its own raise the age of people in state prison. Right now 16- and 17-year olds are going to state prisons and that, I believe, is an intolerable situation. So by executive action we will take 16-and 17-year olds out of state prisons and put them in separate facilities which will be designed and managed by the Department of Corrections and OCFS." These institutions will be a much easier going place for the young gangbangers and will give them a chance to hook up with their homies. Escape would be much easier. Cuomo knows this but has national ambitions and wants to appease the African-Americans.

Then there are the professional overt cop haters. This group is led by Al Sharpton and his National Action Movement. Its Major Black Supremacist players include Louis Farrakhan, Jeremiah Wright, Obama's racist pastor, the New Black Panthers and the Black Guerilla Family. Much of their "cops are an occupying force in the ghetto and must be offed" thought originated with the Weather Underground. As a result the Weathermen bombed New York City Police Headquarters in 1970. The Weathermen were inspired by the original Black Panther Party whose slogan was "Off the Pig."

A very important part of the *Cop Killing Lobby* are the rappers and "aspiring rap artists." While on patrol in July 1992, two Las Vegas police officers were ambushed and shot by four juvenile delinquents who boasted that Ice-T's *Cop Killer* gave them a sense of duty and purpose, to get even with "a fucking pig." The juveniles continued to sing its lyrics when apprehended.¹¹⁴ Martin D. Payson gave his rationale for Warner Bros recording and mass-marketing *Cop Killer*.

114. *Dark Side of the Tune: Popular Music and Violence*. By Professor Bruce Johnson, Professor Martin Cloonan

THE NEW CROW JIM



Ice-T is attempting to express the rage and frustration a young Black person feels in the face of official brutality and systematic racism. Though the incidents of brutality may be perpetrated by a small number of police, the impact on the Black community is intense and widespread. The anger that exists is neither an invention of Ice-T's nor a figment of the creative imagination. It is real and growing. Our job as a society is to address the causes of this anger, not suppress its articulation.

Martin Payson and many early rap producers were Jewish. Payson lives at 210 East 65th in Manhattan where rental for a one bedroom starts at \$14,700 a month. Payson doesn't believe a word of what he said. He loves the police as they enforce the social order in Manhattan. As long as he makes money from hip hop and rap he will say anything he has to so that he will continue to profit from the disintegration of the Black community. Pictured below are Payson the Pimp's crib and his 'ho Doris.

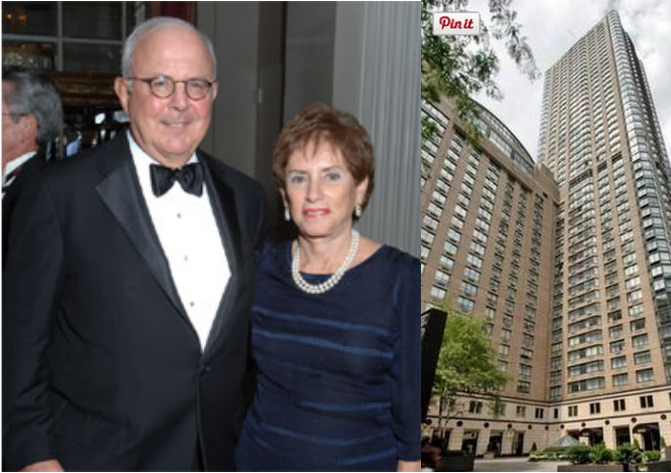

The Jewish Defense Organization went after Rick Rubin who signed *Public Enemy*, mental misfits who claimed the Jews were responsible for all the evil in the world and that the words Jew and Jewelry were related. The rappers engage in a primitive form tribal warfare, shooting rival rap groups. Every gangster that gets shot is termed “an aspiring rap artist.” Thanks to Obama, the first ditty-bopping President¹¹⁵ Hip Hop Rap “culture” has reached the White House.

The White House today announced that Deesha Dyer has been promoted to Special Assistant to the President and Social Secretary. She currently serves as Deputy Director and Deputy Social Secretary. Deesha was selected from among an abundance of well-qualified candidates for her passion and dedication to opening the doors of the White House, most notably engaging students from communities across the country.

115. Trump: “The way President Obama runs down the stairs of Air Force 1, hopping & bobbing all the way, is so inelegant and unpresidential.”

THE NEW CROW JIM

Dyer has also maintained a long-standing commitment to community advocacy in several roles, including her role working with young adults at the Youth Health Empowerment Project, as creator of a hip-hop AIDS program based in Philadelphia as a CARE advocacy volunteer and as a Board member at Action AIDS. At the age of 29, Dyer returned to college to obtain her associates degree in Women's Studies from the Community College of Philadelphia.¹¹⁶

Dyer was picked because she is African-American not because she is qualified for the job. How many other White House staffers have a community college education? When Dyer was working for the alternative press in Philadelphia she promoted books that glorified gangbanger culture like *Tor'cha*.

Let me give you a little preview/teaser. *tor'cha* tells the tale of 3 brothers in the hood... The book digs deep into their lives. Namely, Emil (a stick-up kid turned musician), Damon aka Abdullah Zahir (incarcerated felon turned Muslim) and Christian (escaped the streets via education).

While they struggle with what is right vs. what is easy, they are faced with the breaking of the Ten Commandments and the morals from Supreme Mathematics, an Islamic concept that originated from the Nation of Gods and Earths.¹¹⁷

116. <https://www.Whitehouse.gov/the-press-office/2015/04/16/White-house-announces-deesha-dyer-social-secretary>

117. <http://www.Blackerinkwells.com/2008/05/15/deesha-dyer-geoclan-interview/>

She was also a fan of the gangster rapper Joey Jihad.

First, let's identify the primary subspecies: The hipsters (Spankrock, Amanda Blank, Plastic Little, Diplo). And the DVD cats (Joey Jihad, Reed Dollarz).

When Joey Jihad was free-styling on the street another Black came out of nowhere and sucker punched him from his blindside in the middle of a line. Joey had that man killed. Joey's songs include: *Dope Boy Swagg* (Prod. by Jumbo Beatz) and *Hoodlife*. She was also a fan of Reed Dollarz who wrote *Gorilla Music*.



Obama is the hip hop gangsta president just as Kwame M. Kilpatrick, was the Hip Hop mayor of Detroit¹¹⁸ before being sentenced to 28 years in federal prison for doing what most Black politicians in Detroit do – steal. Obama attended a hip hop Broadway Show *Hamilton*, where Blacks and Latinos play the roles of slave holders like Jefferson and Washington, sort of a minstrel show in reverse however Blackface has been banned from Shakespeare's *Othello*. Farrakhan claims that the police have targeted the hip hop community:

118. <http://www.daveyd.com/newsdetroitmayorhiphop.html>

THE NEW CROW JIM

The West Coast rapper known as The Game has been charged with hitting an off-duty Los Angeles police officer during an altercation at basketball game earlier in March. The Game, whose real name is Jayceon Terrell Taylor, met with Min. Farrakhan June 17, but even before that recent meeting and subsequent interview with The Final Call in which he pledged support for the #JusticeOrElse movement, he released the single “Don’t Shoot” in the summer of 2014 as a tribute to Michael Brown Jr., the teenager killed in Ferguson, Missouri.

Officials in Georgia said rapper Rick Ross, whose real name is William Roberts, was released July 6 from a Fayette County jail after posting \$2 million in bail on charges of kidnapping, aggravated assault and aggravated battery. Arrest records say Roberts is accused of forcing a man into an area at his metro Atlanta mansion June 7 and beating him with a handgun, leaving him with an injured jaw. He was arrested on June 24, less than 48 hours after he met with Min. Farrakhan.



Farrakhan blamed these arrests on the Anti-Defamation League.¹¹⁹ The Black racist KKK shock troops of the *Cop Killing Lobby* consist of *lumpen* Black looters, the one third of African-American males involved with the criminal justice system and college kids looking for a cause who think that Michael Brown and Rosa Parks stood for the same ideals. African-American Muslims are also involved.

COMEY AND THE HOMIES



119.

http://www.finalcall.com/artman/publish/National_News_2/article_102478.shtml

THE NEW CROW JIM

On February 12, 2015 James B. Comey Director Federal Bureau of Investigation had this to say about the gangbanger culture.¹²⁰

So many young men of color become part of that officer's life experience because so many minority families and communities are struggling; so many boys and young men grow up in environments lacking role models [fathers], adequate education, and decent employment—they lack all sorts of opportunities that most of us take for granted. A tragedy of American life—*one that most citizens are able to drive around because it doesn't touch them*—is that young people in “*those neighborhoods*” too often ***inherit a legacy of crime and prison***. And with that inheritance, they become part of a police officer's life, and shape the way that officer whether White or Black sees the world. Changing that legacy is a challenge so enormous and so complicated that it is, *unfortunately, easier to talk only about the cops. And that's not fair.*

“A tragedy of American life - *one that most citizens are able to drive around because it doesn't touch them* - is that young people in “*those neighborhoods*” too often ***inherit a legacy of crime and prison***.” Comey is on dangerous ground talking about the Black Criminal Subculture. His former overseer Eric Holder believes that there is no such thing, just a bunch of misguided youth.

After the fabric of America changes citizens will no longer be able *drive around* it because it will be in their own backyards. Comey:

120. <https://www.fbi.gov/news/speeches/hard-truths-law-enforcement-and-race>

But the “seeing” needs to flow in both directions. Citizens also need to really see the men and women of law enforcement. They need to see what police see through the windshields of their squad cars, or as they walk down the street. They need to see the risks and dangers law enforcement officers encounter on a typical late-night shift.

The must realize it is a jungle out there.

They need to understand the difficult and frightening work they do to keep us safe. They need to give them the space and respect to do their work, well and properly. If they take the time to do that, what they will see are officers who are human, who are overwhelmingly doing the right thing for the right reasons, and who are too often operating in communities—and facing challenges—*most of us choose to drive around.*

Comey is telling the African-American community not to try to interfere with arrests of “brothers” because they are the ones who are making life a nightmare in ghetto by selling dope. The dopers become burglars, muggers, car jackers to support their habit. The community starts to become crime ridden and the Whites leave abandoning their homes. The homes become crack houses. No civilized person White or Black wants live in a neighborhood like this; but instead they avoid and drive around. He is saying ‘So if you don’t like the way the police handle things, but avoid the reality of high crime Black neighborhoods, shut-up.’ So, in light of FBI Director Comey’s statement look where Obama stands in relation to Trayvon Martin, who, like so many other young Black men was part of this gangbanger subculture. Obama was asked to comment on the Trayvon Martin / George Zimmerman case:

THE NEW CROW JIM

Well, I'm the head of the executive branch. And the attorney general reports to me. So I've got to be careful about my statements to make sure that we're not impairing any investigation that's taking place right now.

This murder was not a federal offense. Obama was prejudging the situation before it was adjudicated by calling for a Civil Rights investigation.

But obviously, this is a tragedy. I can only imagine what these parents are going through. And when I think about this boy, I think about my own kids.

What about what Zimmerman is going through having his head beat into the ground by a thug? What have Obama's daughters have in common with Trayvon? Race and that is all.

And you know, I think every parent in America should be able to understand why it is absolutely imperative that we investigate every aspect of this. And that everybody pulls together, federal, state and local, to figure out exactly how this tragedy happened. So I'm glad that not only is the justice department looking into it, I understand now that the governor of the state of Florida has formed a task force to investigate what is taking place. To do some soul searching to figure out how does something like this happen?

And that means that we examine the laws and the context for what happened. As well as the specifics of the incident. But my main message is to the parents of Trayvon Martin. ***You know, if I had a son, he would look like Trayvon.*** And, you know, I think they are right to expect that all of us as Americans

are going to take this with the seriousness it deserves and that we're going to get to the bottom of exactly what happened.

What does "You know if I had a son he would look like Trayvon" mean? If Obama had a son he might be walking through a White neighborhood and be murdered because of his skin color. But that's not what happened. Trayvon jumped Zimmerman. Obama is jumping to conclusions and making this into a racial incident before the facts were in.

Trayvon was a gangbanger. His posts on social media were about drug dealing and violence. He had been suspended from school for pot and tagging before he attacked Zimmerman. Yet Obama defended him because Obama once aspired to be a Black gangster and now he is a Black racist and as the old saying goes, *Bloods are thicker than water*. Now every time a Black thug, rapist, murderer, cop killer is identified someone comments: "If Obama had a son he would look like him" Obama's speech has become a big joke.



This is a photograph of Trayvon Martin holding a gun taken from the *My Black World* website.

One aspect of the Trayvon Martin affair that is largely overlooked is the fact that with Trayvon, we were given a random

THE NEW CROW JIM

sample of male African-American youth. Trayvon's mother, who worked for Dade County in Miami couldn't handle him so he was temporarily farmed out to this father Tracy who was living with a Correction Officer who was at first described as a girl friend then fiancé. Martin had been employed as a truck driver in the same company for sixteen years. So poverty was not a factor in Trayvon becoming a part of the Black criminal subculture.

By making the *Trayvon could be my son* statement Obama sent a message to every potential African-American juror to convict Zimmerman. It meant Trayvon was a good boy set upon by a racist White. Obama was questioning Zimmerman's testimony before he even heard it. During Reconstruction, on October 26, 1866, the Texas legislature passed a law redefining the circumstances in which Blacks could testify in court. Rather than simply establish that Black people would have full and equal rights to testify, Texas lawmakers crafted a statute that provided that "persons of color shall not testify" except in cases where "the prosecution is against a person who is a person of color; or where the offense is charged to have been committed against the person or property of a person of color." Obama's version is that a White's testimony against a person of color is not to be recognized by the courts. The way the case played out Zimmerman walked and Obama was unable to poison the jury pool because African-Americans only account for 12% of the population.

But Obama attempted to weaken the judiciary with his incendiary statement. It is not up to him to determine guilt or innocence like some tin-horn dictator who controls the judges that stage show trials. He had no business commenting on this until it played out in the courts. He tipped his hand.

A. J. WEBERMAN

Many people suddenly realized Obama had a ghetto mentality and wanted Zimmerman to allow himself to be beaten, perhaps to death, or incur brain damage, rather than defend himself against this Black thug. Trayvon's girlfriend testified that Trayvon called Zimmerman a "creepy cracker" and thought he was gay. Trayvon was the racist and homophobe but when an African-American is involved the liberal's political correctness goes down the drain.

THE RATNER PACK



Bruce Ratner, Michael Ratner, and Roger O. Goldman

This might come as a shock to the reader but one of the biggest funders of De Blasio and *The Cop Killing Lobby* is the developer Bruce Ratner. Ratner funded the *Center for Constitutional Rights* and the *National Lawyers Guild* through his Israel hating brother Michael Ratner who croaked in may 2016 at age 71 . Michael Ratner's ex-wife Margaret Ratner is widow of the cop hater and Israel hater William Kunstler, and the moving force behind the *Center for Constitutional Rights*.

Kunstler and convicted terrorist Lynne Stewart, released by the Obama Administration a year ago as a terminal patient but still alive and kicking, represented the thug Larry Davis. A Bronx jury acquitted Davis of attempted murder of nine police officers in a blazing shootout in 1986. One juror said later that the jury believed Davis's assertion that he had fired in self-defense after he was shot at. The jury also acquitted Davis of six counts of aggravated assault in the wounding of six of the officers, one of whom was hit in the mouth and neck by a bullet and forced to retire. But the jury convicted him of six counts of criminal possession of a weapon.

Kunstler told reporters that the verdict "sent out a message that White officers are not going to be able to shoot down Black youths without a proper response."

Six of the seven officers who burst into the apartment the night of November 19, 1986, were White and one was Hispanic. Davis is Black. Thomas McCarren, the most grievously wounded of the officers in the shootout, said: "I think that the jury should be ashamed of themselves. It was a racist verdict." Ten of the jurors were Black and two were Hispanic. Speaking of the raid that led to the shootout, McCarren, who retired as a detective from a bullet wound to the mouth and neck, said, "The day this happened, a bunch of good honest police officers went to lock up Larry Davis because he had killed people, and not for anything else."¹²¹

Kunstler claimed Davis was targeted because he was going to blow the whistle on police corruption, an outright lie. This entire episode was right out of *Bonfire of the Vanities*. Larry Davis ended up being killed in a prison facility for those who attacked other inmates. After Davis's death WBAI radio personality Bob Fass tried to make him into a hero. The JDO spoofed Fass's email address and

121. <http://www.nytimes.com/1988/11/21/nyregion/jury-in-bronx-acquits-larry-davis-in-shooting-of-six-police-officers.html>

sent out an invitation to Fass's email list that Fass was sitting shiver for Davis, and everyone was invited. Light refreshments would be served.¹²²

Kunstler was hated by NYPD for his defense of Davis and was once beaten by the Court Officers in New York City courtroom. The Michael Ratner and Margie Ratner's are extravagant spenders, having paid \$100,000 for a custom built barn for one prize goat. The first time this writer ever had kitsch was at William Kunstler's home on Gay Street in Greenwich Village. Later the Jewish Defense Organization picketed this townhouse. Michael Ratner is also an investor in Brother Bruce Ratner's Atlantic Yards development, which includes Barclay Center.

Forest Ratner builders of the Criminal Courthouse in Brooklyn are a bunch of crooks with so much political influence even the United States attorney is afraid of them!

THE LONGFELLOW PROJECT

In 2003, a developer ("Developer No. 1") proposed to develop a tract of land located partially within the Yonkers City Council District represented by Sandy Annabi by renovating and transforming two vacant and dilapidated schools into market-rate housing (the "Longfellow Project"). Annabi initially opposed the Longfellow Project. During a City Council meeting on June 14, 2005, Annabi proclaimed her strong opposition to the project, stating: "Even if the entire community supported [it], I would be opposed."

122. <http://www.villagevoice.com/news/yippie-apocalypse-in-the-east-village-6388142>

THE NEW CROW JIM

She also said that the project was “outrageous” and a “slap in the face to the taxpayers of Yonkers.” Despite considerable effort, Developer No. 1 was unable to move the project forward in the face of Annabi’s opposition.

In April 2006, however, Developer No. 1 hired Anthony Mangone to assist in persuading Annabi to support the Longfellow Project. Shortly thereafter, Mangone arranged a meeting between a representative of Developer No. 1 and Jereis, who advised that he could help persuade Annabi to support the project. Later, Mangone told Developer No. 1 that, in order for the project to proceed, Developer No. 1 would have to pay Annabi tens of thousands of dollars in exchange for her support. Developer No. 1 gave Mangone tens of thousands of dollars in cash for Annabi and paid Mangone a cash fee for his services.

Shortly after receiving the money, Annabi made several substantial cash and credit card purchases -- including airline ticket upgrades, a Rolex watch, and a diamond cross necklace. Then, at a City Council meeting in September 2006, Annabi reversed her long-held opposition to the Longfellow Project and voted in favor of awarding the project to Developer No. 1.¹²³

It was obvious that Ratner AKA Developer No. 1 used a cut out. The Feds arrest Annabi and Mangone but not the real crook, Bruce Ratner.

123. <https://www.fbi.gov/newyork/press-releases/2010/nyfo010610.htm>

Bruce Ratner's *Center for Constitutional Rights* is based on the assumption that the entire NYPD is racist:

How can anyone in the community have faith in the system now? First Ferguson, now Staten Island. The Grand Jury's failure to indict sends the clear message that Black lives don't matter. But they do. It's bad enough that broken windows policing over something as harmless as selling untaxed cigarettes led to this tragic killing; it's even worse when the officer responsible – who was caught on tape using a prohibited choke hold, no less – is not held accountable. The problem isn't one officer, though: it's systemic.

We need real reform of discredited broken windows policing and of the NYPD more than ever. *With the court-ordered joint reform process in our class action stop-and-frisk case Floyd v. City of New York finally getting underway, we have that opportunity.*¹²⁴

In the name of Civil Liberties, these Communists who hate America for destroying the Soviet Union try to use the courts to tie the hands of the police so that criminals and terrorists can attack the evil United States. They, like De Blasio, believe that the Founding Fathers were a bunch of racist, capitalist pigs just trying to get out of paying taxes to the British. All of this turmoil cost New York the 2016 Democratic Presidential Convention. Another factor was that De Blasio was intent on using his buddy Bruce Ratner's Barclay Center as the venue. Due to a lack of hotel rooms in Brooklyn, where the center is located, delegates would have had to commute to and from Manhattan.

124. <https://ccrjustice.org/home/press-center/press-releases/ccr-executive-director-responds-grand-jury-failure-indict-nypd>



During the New Reconstruction Period the Muslims living in America remain loyal to the Umma, the Muslim super-State and while only a few American Muslims make jihad, many others have formed terrorist support groups like CAIR, the Council on American-Islamic Relations. CAIR tries to *hamstring* the police and federal law enforcement to make it easier for terrorists to carry out their vile acts in the United States. The first responders to these events are police so you can see where *Terrorist Lobby* and the *Cop Killing Lobby* would have a natural affinity for one another. CAIR participated in the attacks on police in Ferguson, Missouri and was joined by Missouri State Senator Jamillah Nasheed and her aide Eric Vickers, both Muslims.

It comes as no surprise that Michael Ratner, of the *Cop Killing Lobby* was honored by CAIR. Al Sharpton appeared at a CAIR fundraiser and will do so again. Like the *Cop Killing Lobbyists* who want to create a favorable environment for criminals to operate in, CAIR wants to create a favorable climate for terrorists to operate in by pretending to be for civil liberties when in reality they wish to create a Shar'ia law state.

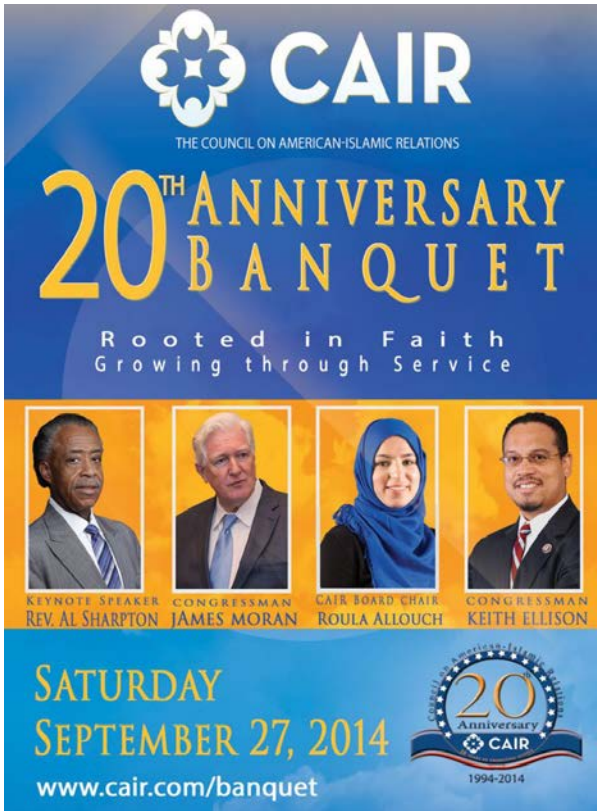

In May 2016 this traitor to America and traitor to the Jews died of complications from cancer. The Rat's mother helped resettle refugees from the Holocaust yet the Rat did everything he could to destroy Israel, a country partially founded by Hitler's survivors. The Rat was on a jog in Lower Manhattan when hijacked airplanes hit the twin towers. "The idea that I would actually represent someone who bombed the World Trade Center didn't sit so well with me," he told Newsday. "It didn't seem what I wanted to do." But the Rat did it anyway winning the right of Habeas Corpus for mass murdering Muslim scum.

THE NEW CROW JIM

He also defended Julian Assange an American hating Australian turd, whose website WIKILEAKS serves as a conduit for leaked information released to destroy America. After the rat croaked, his sister Ellen took up with Randy Credico, an alcoholic failed comedian, who worked closely with Roger Stone, a pot smoking Trump dirty trickster. Credico took the 5th when called before a Congressional Committee investigating Russian collusion in the Trump / Hillary election.



CAIR's national executive director Nihad Awad made it clear what CAIR wants Obama to do in relation to ISIS.

American Muslims will evaluate the president's strategy *based on his willingness to reject ISIS' misappropriation of Islamic terms and concepts, and his recognition that ISIS was created and is fueled by the lack of freedom and justice in the region.*

If we want to stop ISIS, we must deny it any claim to represent Islam *and starve it of the fuel of injustice.* It is up to our political leaders to take the lead through a comprehensive international strategy, *not in the number of bombs that can be dropped, but in the*

establishment of the freedom and justice that will spell the end for ISIS and its ilk.

ISIS isn't Islamic. It was created by Jews: The *lack of freedom and justice* is a coded phrase meaning the existence of the State of Israel. That is what is fueling ISIS not the Qur'an. It's the Jews. "Starve it of the fuel of injustice" means cut off aid to Israel. "Not in the number of bombs that can be dropped" CAIR doesn't want America to bomb ISIS.

CHAPTER TEN

THE MEDIA AND THE COP KILLING LOBBY

The *New York Times* ran an editorial praising Black Lives Matter and the media in general, especially Black commentators, play a big part in *The Cop Killing Lobby*. Obama:

A media that is so splintered now that we are not in common conversation and the fact that if you watch *Fox News* you inhabit a completely different world with different facts than if you read *New York Times* and that becomes self reinforcing and there is a profit both for politicians and for news outlets in simplifying and polarizing and so all those things have combined to make our political institutions detached from how people live on a day to day basis. And that's part of why people get so frustrated and they get so cynical but ironically you get a negative feedback loop right when people start thinking what is happening in Washington is so different from the way I see things that I am not even going to bother to vote or bother to listen as a consequence then the public withdraws you get an even worse political gridlock and polarization. So the issue is not the American people that is where my faith is. The question is how do we build institutions that allow the goodness ***decency of ordinary folks*** to express itself in the decisions that are made in how the country moves forward.

This tells us that as *Pravda* was the official newspaper of the Soviets the *New York Times* is the official newspaper of the Obama Administration.

Obama espouses populist rhetoric but in reality he is racist and has allowed “decent ordinary folks” carpetbaggers like Al Sharpton a place in his administration.

Ever since a Black man, Dean Baquet, became managing editor of the *New York Times* the *Times* has gone out of its way to justify that actions of cop killers. Ismaaiyl Abdullah Brinsley a Muslim with 20 arrests who murdered two policemen is a prime example. In a story that took up the entire back page of the *New York Times* we are supposed to feel sorry for this excuse for a human being:

He was the difficult teenager who was passed around from home to home, the adult who could make nothing work, not a T-shirt company, not even an attempt on his own life at a former girlfriend’s house. Everyone seemed to betray him. The friends who pistol-whipped and robbed him in May 2014. The girlfriend who dumped him around Thanksgiving. In recent weeks, Brinsley was unraveling, increasingly desperate, the gap between the life he wanted at age 28 and the life he had looming ever larger. If he couldn’t get it together, he told the mother of his second child in early December, he would kill himself.¹²⁵

Poor Bubbala: Dean Baquet, who was Executive Editor when this story was printed, and still is, has nothing to fear from Brooklyn scum like Brinsley because he lives in a lily White neighborhood at 21 East 10th Street a few doors from 5th Avenue where prices start at \$1,700,000.

125. <http://www.nytimes.com/2015/01/03/nyregion/ismaaiyl-brinsleys-many-identities-fueled-life-of-wrong-turns.html>

THE NEW CROW JIM



THE PROUD BLACKMAN AND HIS WHITE WIFE



A. J. WEBERMAN



New York Times Publisher Arthur Salzberger Jr. residence at 171 W 71st Street. Apartments there start at 10 million dollars.

When Michael Brown tried to disarm Officer Darren Wilson a shot was fired in the car and it hit Michael Brown's arm. Sara Sidner of CNN described the incident as a "scuffle" rather than an attempt by Brown to obtain Wilson's weapon and shoot him with it. The entire African-American community of commentators left out this incident entirely or attributed this to White racist lies, all thinking alike.

That is scary. There was hardly a word of dissent in the Black media that just maybe Wilson was defending himself against Brown who was attempting to steal his run then began rushing toward him. ***It seems as if a majority of the African-American community, including those in the media, want to make cop killing an entitlement.***

Margaret Hoover, Sally Kohn and Mel Robbins were the CNN commentators who revealed their bias by holding up their hands as they believed Michael Brown did before Officer Wilson shot him. But the Justice Department reported this never happened and that Brown tried to kill Wilson. By holding up their hands these commentators were signaling their approval of killing police officers. Sunny Hosten, holding the sign, claimed she lives in the Bronx when in reality she lives in a plantation-like mansion in Purchase, New York. She claimed to be a Puerto-Rican Boricua down with her homies but when this researcher published her address on Twitter she reported him for “targeting.”

Maybe these CNN commentators got a different take on Black crime after Vester Lee Flanagan, a self admitted Black racist murdered two television reporters in Roanoke Virginia.

The hidden agenda of the *Cop Killing Lobby* is to get more police killed and injured because the police are enforcing the laws of what is perceived as an evil White racist America with a history of slavery and Jim Crow. The lobby claims with America’s checkered past, it is likely Blacks are unfairly targeted by law enforcement. It writes off the Black Criminal Subculture as irrelevant.

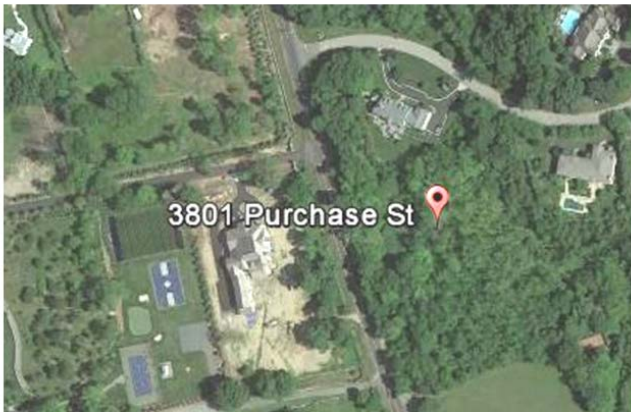

VAN JONES' WIFE



THE NEW CROW JIM

Van Jones, a former Green Energy Czar appointed by Obama is married to Jana Carter a follower of Anthony Buzzard,¹²⁶ a Jew hating propagandist for replacement theology in which ethnic Israel is no longer viewed as God's covenant people, but rather the Church has fully and permanently replaced Israel.

Israel has not yet been converted to the Christian Gospel of salvation, nor to the ethic of the New Testament. Paul calls them "enemies of the Gospel" (Rom. 11:28). They are a worldly government just like all other current governments. They have been brought back to their historic homeland in unbelief, just as our forefathers in the Abrahamic faith envisioned. But they needed to be there in their unbelief in order for God to deal with them in that land, just as His prophets foretold. In the future a collective national repentance and turning to the Messiah is to be expected. "Thus all Israel will be saved" (Rom. 11:26).¹²⁷

Van Jones blamed the race riots in Ferguson Missouri on "knuckleheads." A knucklehead is defined as a stupid, bumbling, inept person, not an evil one. Jones:

The vast, vast majority of people out there at the very beginning were trying to be peaceful. Then you saw way down the street **a bunch of knuckleheads** start a bunch of nonsense. Then [the police] started bombarding with tear gas.

126. <https://www.linkedin.com/pub/jana-carter/0/281/49b> She is currently attending Buzzard's Seminary School.

127. <http://focusonthekingdom.org/85.htm>

A. J. WEBERMAN

Most of the people who were out there for good reasons started to leave in large numbers. The small number of people who were left were either social bloggers and videographers or people who out there trying to start trouble.

Don Lemon, a gay black boozier, was one of the few CNN commentators to tell the truth about Ferguson. Lemon:

How do you know who's peaceful in a crowd of people who are racing toward you? How do police know whether it's water or urine or [a] Molotov cocktail in a bottle when people say 'why are they getting upset, why are they arresting people?'



Jones blames Whites for the Ferguson race riot:

It was horrible. There was some other things I thought that people may not have noticed. I've never seen African-American youth with those Anonymous masks on.

THE NEW CROW JIM

LEMON:

What is your observation about that? You think that there's something interesting. You think this was – you think much of this was led by anarchists, you believe?

JONES:

It's hard for me to know that for sure, but it's unusual for culture to jump White to Black. Usually you have African-American kids, they like hip-hop. Then the White kids like hip-hop. It's a way that culture moves.

LEMON: African-American kids sag.

JONES:

Sag their pants, White kids sag their pants. Usually culture moves from Black to White. It's just been that way in the country since Elvis Presley. Last night, you saw a White cultural phenomenon of those Anonymous masks, those Guy Fawkes masks, being worn by African-American protesters. When I saw that, I was shocked. I said this is going to be a different kind of protest.

LEMON:

OK, I'm going play devil's advocate here because people are going to say, oh, now you're blaming the rioting and the looting and all the unrest on White people.

JONES:

Oh, no, not at all. That is not what I'm saying at all. I'm saying that there's a particular rhythm to the way protests work, the things that you've used to seeing. You can call it -- last night there was a different mix of people out there than you saw before.

The mix last summer when we were here was overwhelmingly local folks who had local grievances and you had a few people from the outside. At least from a cultural influence point of view, what you saw last night was much more that global protest movement showing that almost like Occupy in Ferguson.

LEMON:

Along with Anonymous. Do you think there was an orchestration that we didn't necessarily see playing out? There was some undercurrent of -- that was orchestrated by --

JONES:

I think when the police get to the bottom of this, my prediction is going to be you're going to find that there's probably five to ten people that set most of those fires. You didn't see people running around with Molotov cocktails, that kind of stuff, but all of a sudden you see fires popping up and it was very, very organized the way that happened. That was not the crowd. That was a smaller group of people. I guarantee you, when the police look into this, that -- and that was horrible. That was horrible.

THE NEW CROW JIM

LEMON:

Where -- but it's not Anonymous, it's not Occupy, it's not -- that you see on the video breaking into stores and businesses and looting. You don't see that --

JONES:

Two different things. The looting you saw was just *knuckleheads* out there with baseball bats, shaming this community, shaming Mike Brown's family, doing exactly what the family said not to do. That is inexcusable. I'm saying there was something else happening. The arsons were not the same as the looting. And if you saw the sequence of the arsons, that was a different group.

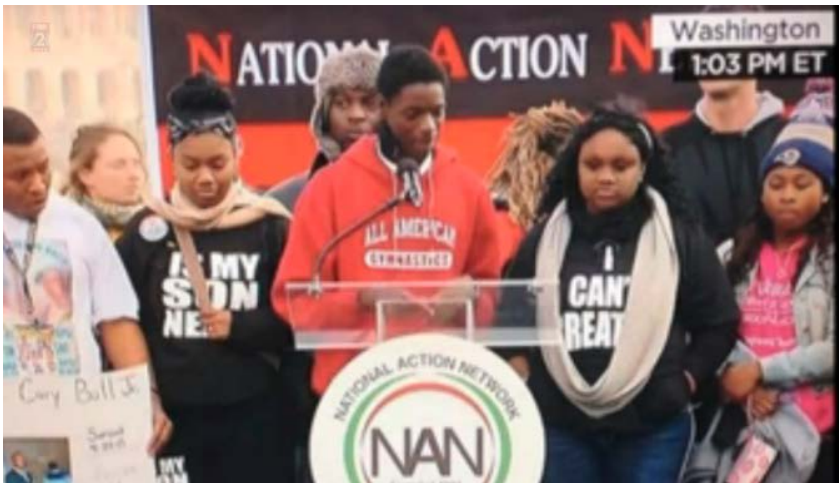

JOSHUA WILLIAMS AND ERICKA GARNER

Erika Garner, 27, died in December 2017 in Woodhull Hospital in Brooklyn, NY at. The New York Times reported no official cause of death was released leading this researcher to believe she had weakened her heart from smoking crack. This hero of the Black Criminal Subculture had two fatherless children.

Joshua Williams was the only protester charged with arson for burning down a Quick Trip convenience store. But this mendacity should not be unexpected as Van Jones signed a petition calling for congressional hearings and an investigation by the New York Attorney General into "evidence that suggests high-level government officials may have deliberately allowed the September 11th attacks to occur." Jones' excuse for signing the petition that got him canned:

Six years ago, I was at a conference, some people came up to me. They said, 'Hey, we represent 9-11 families.' I'm like, 'OK, good to meet you.' They said, 'We need your help. Will you help us?' I said, 'Sure, whatever you want.' And then these people, I didn't know what their agenda was, they went and put my name on some abhorrent, crazy language they never showed me, I never saw. And it just sat there on this web site for years. Somebody discovered it, and then boom. So people actually believe that I actually signed onto something that I never saw and never signed onto. And that became part of the firestorm. I decided at that point that I needed to resign because I was becoming a distraction.¹²⁸

What a lying Black racist. Jones is part of the *Cop Killing Lobby*:

Van Jones is the founder and executive director of *Bay Area Police Watch*, an organization committed to stopping police misconduct and protecting victims of abuse. *Police Watch* takes a multifaceted approach, combining advocacy with public education and community organizing.

128. http://www.huffingtonpost.com/2010/02/24/van-jones-explains-911-pe_n_475960.html

THE NEW CROW JIM

Jones works directly with individuals who have suffered from police harassment, intimidation, and brutality. His efforts to establish civilian oversight and to require transparency and accountability within disciplinary proceedings has yielded results. Jones's efforts to ban the use of pepper-spray routinely used by police in subduing suspects, has helped launch a nationwide campaign against the chemical weapon.

The *Police Watch* Hotline documents callers' complaints and refers victims to lawyers who are, in turn, trained by *Police Watch* in handling misconduct cases. Police Watch then helps victims and lawyers through legal proceedings, organizes community support, and advocates on behalf of victims to public officials and the media. Jones's efforts have offered a corrective lesson those egregious abuses of human rights still take place even within the vaunted protection offered by the democratic laws of the United States.¹²⁹

Van Jones has also started an organization dedicated to bringing Black criminals back into society:

Our system is broken. Our mass incarceration industry locks up too many people, wastes too much money, ruins too many lives, and fails to make our communities safer. One out of every 100 Americans is behind bars. The U.S. spends \$80 billion yearly on incarceration. *And people of color bear the brunt of this broken system.*

129. <http://www.pbs.org/speaktruthtopower/van.html>

We can't afford this. Over-incarceration devastates our country, particularly communities of color.

The U.S. has 25 percent of the world's prison population even though we only make up 5 percent of the globe. With the amount of money we spend on incarceration every year, we could fund college tuition for almost 16 million students. But in many neighborhoods, young people of color are more likely to go to prison than college.

Our communities need fewer people behind bars, less bias and discrimination in our courts, and more money diverted from prisons to community-based alternatives. Now is our chance to call for reform.

Did in ever cross Jones' "the US Government did 911" mind that the reason more "people of color" are in prison is because they commit more crime? This is not entirely because of poverty – America has the world's richest poor – but also because of culture. Yeah let's let the psychopaths out of the joint and use that money to fund college tuition for 16 million Blacks more than half of whom will drop out. Can you imagine what this society would be like if all the gang members now behind bars were freed? The ones who are tattooed from head to foot? And let's not forget the skinheads, Nazis and assorted Aryan Nation scum that would be cut loose if that 18 billion dollars was diverted into education. What dreck has been brought into the mix during the New Reconstruction Period. Van Jones, a cop-hating 911 revisionist who wants to free rapists and murderers.

The *Cop Killing Lobbyists* like Van Jones ignore the existence of a criminal subculture where crime is the norm and one out of three African-American males get caught up in the criminal justice system not because of abject poverty but because they make a

THE NEW CROW JIM

conscious choice to become a gangbanger. According to the *Cop Killing Lobby* poverty is entirely to blame and criminals have no free will. The only one willing to address this issue in the Obama administration was FBI Director James Comey.

CHAPTER ELEVEN

OBAMA'S RACIST BROTHERS



If a White President was tight with a White racist he might be impeached. But if a Black president is close to a Black racist that is okay. Everyone knows Obama's so-called Minister was Jeremiah A. Wright a close associate of Louis Farrakhan who shares his belief that the White man is racially inferior to the Black man. He is a New Reconstructionist, not a pastor. In March 2007 Obama stated:

*I must send greetings from Dr. Jeremiah A. Wright Jr. but I got a letter giving me encouragement and saying how proud he was that I had announced and encouraging me to stay true to my ideals and my values and not to be fearful.*¹³⁰

130. <http://www.Blackpast.org/2007-barack-obama-voting-rights-march-commemoration-speech>

Obama praised this wacko who had this to say about Jesus:

Who cares about what a poor Black man has to face every day in a country and a culture controlled by rich White people? ***Jesus was a poor Black man*** who lived in a country and who lived in a culture that was controlled ***by rich White people!*** The Romans were rich. The Romans were Italians, which means they were European, which means they were White -- and the Romans ran everything in Jesus' country. It just came to me within the past few weeks, y'all, why so many folk are hatin' on Barack Obama. He doesn't fit the model! Barack knows what it means to be a Black man living in a country and a culture that is controlled by rich White people!¹³¹

All Black men are like Jesus and all the Whites like the Romans. Jesus, however, was non-violent unlike many Blacks. But if the President's pastor says so it must be true. The Reverend is always Wright. And the Romans – they were just a bunch of guineas, wops. And Barak knows this because he is a Black racist like me. Wright continued:

I am sick of Negroes who just do not get it! We bombed Hiroshima! We bombed Nagasaki, and we nuked *far more than the thousands in New York and the Pentagon*, and we never batted an eye. We have supported state terrorism against the Palestinians, and Black South Africans, and now we are indignant *because the stuff we have done overseas is now*

131. <http://www.foxnews.com/on-air/on-the-record/2012/05/18/cain-rev-jeremiah-wright-obama-connection-still-fair-game-presidential-campaign-not-racist>

*brought right back into our own front yards!
America's chickens are coming home to roost.*

Wright stated that America should have lost more soldiers or increased the number of wounded soldiers rather than use nuclear weapons against the Japanese. Like other American haters he is now on the side of the Japanese during World War II.

Interestingly enough in the early 1940's the Japanese sent intelligence agents into America whose job it was to convince "Negros" to dodge the draft. Elijah Mohammad, early founder of the Nation of Islam, was influenced by one of these agents and went to prison for draft dodging.¹³²



This traitor also stated America deserved 911 as punishment for its past sins and as Malcolm X. stated after the assassination of JFK, "Chickens coming home to roost never did make me sad." He is happy that 3,000 people died, some jumping out the windows of the World Trade Center to their deaths.

Just like the scallywags of the Old South, the Wrights are in it for the money. Jeri Wright, the Rev's daughter depicted above along with her mother, was convicted in March 2014 on 11 counts of corruption, including money laundering and lying to a grand jury, all in a case involving a federal grant.

¹³² <https://www.scribd.com/doc/44713931/WALLACE-FARD-WAS-A-SHEPH-FARD-IC-JEW>

She was also charged with one count of having a nose job to de-accentuate her Blackness. Prosecutors argued for her bond to be revoked after claiming that she was part of a “ghost pay-rolling scheme” at a company in Indiana after her conviction for money laundering. The judge ruled that there was probable cause of her involvement, leading to the decision to put her in jail.

Jeri Wright was convicted of taking \$11,000 as part of a scam involving former Country Club Hill Police Chief Regina Evans, also an African-American. Evans acquired a grant for \$1.25 million dollars to train people to lay brick and electrical wiring, but didn't fulfill the expectations of the grant. As a result of her role in the scheme, Evans received five years in prison.¹³³

After he leaves the White House Obama will be back with Wright who explained why Obama temporarily cut him off.

Them Jews ain't going to let him talk to me. I told my baby daughter Jeri that he'll talk to me in five years when he's a lame duck, or in eight years when he's out of office. The Jews will not let him to talk to somebody who calls a spade what it is. I said from the beginning: He's a politician; I'm a pastor. He's got to do what politicians do.

Wright is nothing more than a Jew-hating Black racist and Obama should have walked out of his church of hate the minute he heard this kind of vile speech. The Wright connection makes Obama the only President to have an indirect connection to Louis Farrakhan - through his pastor and though Al Sharpton, his political advisor.

133. <http://www.chicagotribune.com/news/local/breaking/chi-jeri-wright-money-laundering-case-20150223-story.html>

The Rev. Wright was tight with Farrakhan when Farrakhan and Wright visited Khadafy in Libya, at the time when Libya was an enemy of the United States. Wright and Farrakhan are united by the New Reconstruction Era.



JACKSON AND FARRAKHAN

Jesse Jackson referred to Jews as "Hymies" and to New York City as "Hymietown" in January 1984 during a conversation with an African-American *Washington Post* reporter, Milton Coleman.¹³⁴ Jackson had assumed the references would not be printed because both were Black, but several weeks later Coleman permitted the word to be included in an article by another *Post* reporter on Jackson's rocky relations with American Jews.

Jackson at first denied the remarks, and then accused Jews of conspiring to defeat him in his bid for President. Louis Farrakhan, an old Jackson ally, got into the act and threatened Coleman in a radio broadcast and issuing a public warning to the Jewish Defense

134.

<http://www.washingtonpost.com/wp-srv/politics/special/clinton/frenzy/jackson.htm>

THE NEW CROW JIM

League (JDL), made in Jackson's presence: "If you harm this brother [Jackson], it will be the last one you harm. Leave this servant of God alone." The JDL had started *Jews Against Jackson*. Louis Farrakhan is the Grand Dragon of the Nation of Islam the equivalent of David Duke. If a Republican politician running for the Presidency was close with David Duke the media and the electorate would repudiate him. But it is okay for Jesse Jackson to be tight with Farrakhan.

Jackson's all inclusive Rainbow Coalition was something that didn't go over with Farrakhan who says gays are deviates who go against the natural laws of the universe. This researcher heard Louie give a speech where he promised to wipe out all the sissies in the African-American community by 2010. In 1998, while hanging out with President Clinton, Jesse was having an extramarital affair of his own, with a subordinate baby mom. In 2017 Jackson was accused of sexual harassment by Danielle Young, a writer-producer at *The Root*, in a 2,000-word post alleging that Jackson touched her inappropriately while taking a photo with him. The same day this accusation surfaced Jackson announced he has Parkinson's disease. If the accusation is true we know Jackson is not a Muslim as he embraced this porker.



Rep. John Conyers, the longest-serving active member of the House and a founder of the Congressional Black Caucus, retired from Congress in December 2017 after facing a number of allegations of sexual misconduct. Conyers had this researchers information about the JFK assassination read into the congressional record. John endorsed his eldest son, John Conyers III, to take his place representing Michigan's 13th Congressional District — even though the 27-year-old has never run for political office. John Conyers III, was arrested in February 2017 after his girlfriend suffered knife cuts during an argument. Conyers said that the couple began arguing around 3 a.m. the day after Valentine's Day and that after a physical fight, the police arrested him on suspicion of domestic violence. The Los Angeles County District Attorney's Office later dropped the charges so as to appease the Black community, but the girlfriend got a restraining order against Conyers, which remains in effect until March 2018. "She says I stabbed her, which makes no sense. I didn't do this. She and I had a verbal altercation and that escalated. She pulled the knife on me. She was chasing me. I tried to take it from her. There was a struggle. I pinned her to the wall. She kept swinging and she cut herself."

When Jackson was a waiter at the Jack Tar Hotel in Greenville, S.C. he would spit into the food of White patrons and then smilingly serve it to them. Jesse's carpet-bagging son, Jesse Jackson Jr., or Jesse Crackson Jr. is the spitting image of his father. Former Congressman Jackson was sentenced to 2 1/2 years and his wife, Sandra Stevens Jackson, 49, to a term of 12 months in a federal prison camp. The couple pleaded guilty in February 2013 to using about \$750,000 in campaign funds to pay for items from the pedestrian to the luxurious: car repairs and trips to Costco, in addition to fur wraps and a gold-plated Rolex watch (Jesse bought the replica watch from his crack dealer).

THE NEW CROW JIM

Jesse was too busy smoking crack to attend sessions of Congress and tried to pawn off his addiction as manic depression or bi-polar mental disease.¹³⁵



Reverend Al Sharpton ✓
@TheRevAl

Follow

Leaving the White House party w/POTUS and FLOTUS.
Awesome to see Prince and Stevie Wonder on keyboards
together. Unbelievable experience.

12:35 AM - 14 Jun 2015 · Washington, DC, United States

What kind of a flasluginer President can you trace back to those who want to destroy America? Barak Obama, America's first Black Racist President. Inviting the parents of an attempted cop killer named Michael Brown said it all. Sadly Obama has aligned himself with Al Sharpton and the *Cop Killing Lobby* from the very beginning. The Democratic Party gave legitimacy and respectability to De Blasio's Deputy Mayor Al "the snitch" Sharpton who made a career out of going after White cops some guilty, most innocent, and worked off a beef with the feds by squeaking.



Robert Curington in a mug shot taken after a 2009 arrest

135. <http://www.nytimes.com/2013/08/15/us/politics/jesse-jackson-jr-sentenced-to-30-months.html>

Sharpton and his cop hating National Action Movement is a major player in the *Cop Killing Lobby*. Whenever a policeman shoots a Black man in the line of duty Sharpton is there with the dead person's family, calling for the arrest and conviction of the police officer no matter what the circumstances were. But you never see him show up when a Black kills another Black or an entire Black family. Or when a Black child gets killed in the crossfire.



A drug trafficker who worked for Al Sharpton's nonprofit in the 1980s said that Al was eager to get a slice of the lucrative drug deal captured on FBI surveillance video. "It was greed. He just wanted money," Robert Curington, 72, told *The New York Post*.¹³⁶

Sharpton has said he showed interest in the drug deal only because he feared the undercover agent was armed. He also claimed that he snitched for the feds because the mob was threatening him.

136. <http://nypost.com/2014/04/12/sharpton-was-eager-to-sell-coke-in-the-80s-pal/>

THE NEW CROW JIM

Curington called all of that a lie. He instead provided a detailed account of how Sharpton wined and dined a man he thought was a South American drug lord and said Sharpton met him not just once, but three times.

Sharpton's saga began in the Manhattan offices of boxing big shot Don King in 1983, Curington said. An unnamed felon trying to duck a 30-year prison sentence promised the feds he could help them nail King on coke-dealing charges.

An undercover FBI agent, using the name Victor Quintana, set up a meeting with King to discuss a boxing match in the Bahamas. King introduced him to Sharpton. Sharpton was eager to help, and "would spend cash taking him to dinner and chauffeur him around in a limo, feeling him out," Curington said. Then the agent says "I know where 10 kilos of cocaine are and we can make some big money on this." "Sharpton didn't roll alone he had a friend or adviser with him who says, Hold it! This meeting is over."

Sharpton met with Quintana a second time, in a hotel. Again, cocaine came up, and Sharpton's pals called off the meeting. At the third meeting with Quintana, Sharpton made sure to go alone wearing a cowboy hat and chomping on an unlit cigar, which was made famous in footage from the FBI surveillance leaked in 2002. "The agent said you would get \$3,500 per kilo," said Curington, who was not at the meetings but was told about them by Sharpton. "Sharpton moved on it, and they sprung the trap on him right away. They got him. Al told me himself. He bit and took the bait." And once he was caught, he had no choice but to wear a wire to save him from prison.

Curington, a former hip hop record producer and music promoter who served two years in prison in the late 1970s on drug charges, served as an executive at Sharpton's National Youth Movement in the 1980s.

Curington said Al put on a good show with his bluster and conviction but inside, Sharpton was terrified of his FBI role, recording murderous mobsters like Joseph “Joe Banana” Buonanno. He also squeaked on elected African-American officials, including former Brooklyn Assemblyman Al Vann, former Bronx councilman Wendell Foster, Brooklyn Rep. Major Owens, and Black racist Jew-hating scum Sonny Carson.



Danny Pagano was Sharpton’s closest Organized Crime associate. Sammy “The Bull” Gravano told the FBI:

I know an individual named Danny Pagano, a Genovese associate, who is a powerful force in the construction industry and represents the Genovese Family's interests in Local 59. In the mid-to-late 1980's, I met Pagano in the lobby of either the World Trade Center or the Vista Hotel. Pagano also has strong ties to Local 104, another Local that the Genovese Family exerts influence over, and HRH Construction, a company that the Genovese Family exerts influence over.

THE NEW CROW JIM

Pagano also has a close relationship with Johnny Gammarano, a "made" member of the Gambino Family, who I would regularly rely on to relay messages to people in the construction industry. When the Gambino Family wanted to exert influence at Local 59, the Gambino Family would contact Danny Pagano through Johnny Gammarano. For example, the Gambino and Genovese Families would agree to share a kickback from a contractor who would use Local 59 when the job would be located in Local 23's jurisdiction. On other occasions, John Gotti and I would send a message to Pagano through Gammarano that Local 59 employee could work a job in Local 23's jurisdiction. In return, the Genovese Family would allow Local 23 to do a job in Local 59's jurisdiction.

In March 2015 Pagano was sentenced to 27 months in prison for racketeering after pleading guilty and hiring "Don't Worry Murray" Richman as his attorney.



Sharpton lied about law officers in the Tawana Brawley affair. Brawley was the female version of Dorian Johnson and made up a story that several law enforcement officers kidnapped her and raped her. Tawana was found seemingly unconscious and unresponsive, lying in a garbage bag several feet from an apartment where she had once lived. Her clothing was torn and burned, her body smeared with feces. She was taken to the emergency room, where the words “KKK”, “nigger”, and “bitch” were discovered written on her torso with a Black substance described as charcoal.

The police knew from the start that there were holes in Brawley’s story. For example, a rape kit failed to reveal evidence of rape. She showed no hypothermia or other signs of having been outside and exposed to the elements and freezing temperatures for the amount of time she had claimed. The racial slurs were written upside-down on her body, suggesting that she may have written them herself.

After Al Sharpton and several lawyers started to take charge of the publicity on the case, that’s when her charges got a great deal more specific and became a national scandal:

Sharpton, Maddox, and Mason generated a national media sensation. The three claimed officials all the way up to the state government were trying to cover up defendants in the case because they were White. Specifically, they named Steven Pagonis, an Assistant District Attorney in Dutchess County, as one of the rapists, and called him a racist, among other accusations.

A grand jury ended up finding that no crime had occurred. But many members of the Black community, whipped up by Sharpton and company, believed that Brawley had gotten a raw deal and that guilty and abusive White men had been let off scot-free. This further fed into their perception that they couldn’t get justice from a skewed and racist legal system.

THE NEW CROW JIM

Sound familiar? It should. Sharpton was convicted of libel. Al owes millions of back taxes but will never be civilly or criminally prosecuted due to his new status as a Black “civil rights” leader. All of his for profit businesses failed because of tax liens. When Al Sharpton ran for mayor of New York City in 1997 and for president in 2003, fires at his offices reportedly destroyed critical financial records, and he subsequently failed to comply with tax and campaign filing requirements.¹³⁷

Sharpton is a rat, a crook, a Black racist from the word go and his status indicates civil rights and Black racism and crime have merged.

137. <http://www.nationalreview.com/article/415212/suspicious-fires-twice-destroyed-key-sharpton-records-jillian-kay-melchior>

CHAPTER TWELVE

ERIC “H. RAPP” HOLDER AUTHOR OF “THE NEW BLACK CODES”



Obama appointed a hardcore Black supremacist mole named Eric Holder, who came out of the far Left, as his Attorney General. Holder pretended to be a team player in the Justice Department but once he became Attorney General, he revealed his true White-hating self. Holder’s wife, Sharon Malone, also has a beef with the Whites. Her uncle Henry Malone, was arrested in 1910 in rural Alabama when barely 21, and was jailed for a year and a day. “As best as I can put the story together, it was alcohol-related, a really minor thing, selling it, or he was drunk.”¹³⁸ But even though she claims she can’t remember what the crime was she believes the punishment totally dwarfed the alleged offense.

138. http://www.washingtonpost.com/blogs/she-the-people/post/sharon-malone-eric-holders-wife-on-her-uncles-post-emancipation-re-enslavement/2012/02/09/gIQA9DtY4Q_blog.html

THE NEW CROW JIM

Why didn't Holder get the records on this assuming they still exist? This was a hundred years ago so is it really relevant to race relations today or is it just BS? Is this the best this woman can come up with?



Under the Klan Act during Reconstruction, federal troops were used rather than state militias to enforce the law, and Klansmen were prosecuted in federal court, where juries were often predominantly Black. Under Holder policemen who killed Black criminals were prosecuted in federal court where they were more likely to be convicted or they were investigated by the feds.

Holder did well in the meritocracy. He was one of the few African-Americans to attend Stuyvesant High School in New York City however he resented the other students who were predominately Jewish. Holder got in to Stuyvesant because of a high score on a standardized test and that's what made him so dangerous. He was not an affirmative action Attorney General. "We didn't know if a Black student was going to get admitted," recalled Holder's younger brother, William Holder, a retired Port Authority police lieutenant. "When he got in, it was huge."

It was at Stuyvesant H. Rapp Holder joined the Student Afro-American Society and he continued to be a leading member when he attended Columbia University beginning in 1969. These Blacks were serious Leftwing mini-Black Panthers with a legendary history.

On April 23, 1968, several hundred Columbia students gathered at the sundial on the Columbia campus to protest the Vietnam War led by the Student Afro-American Society (SAS) and Students for a Democratic Society (SDS). They and other protesters marched into Hamilton Hall, Columbia's main undergraduate classroom building, occupied its lobby, and prevented the dean of the college from leaving his office. By morning, the Student Afro-American Society continued to occupy Hamilton, while other Columbia and Barnard students, mostly White, took over President Grayson Kirk's office in Lowe Library. Soon student protesters took over three other buildings.¹³⁹

When Holder arrived at Columbia in 1969 he was recruited by the Student Afro-American society to help take over the R.O.T.C. office. Holder joined several dozen students who occupied the office and renamed it the Malcolm X Student Center. Malcolm X became a Sunni Muslim after he converted from the Nation of Islam's heretical version. Malcolm did this at the urging of Mohammad Mehdi, an early Islamist terrorist facilitator. Had Farrakhan not had him assassinated, Malcolm would have converted African-Americans to traditional Islam. Many of these African-Americans would have become Sunni Islamist terrorists operating within the US. JDO owes Farrakhan for having him knocked off. In Barack Obama's book, *Dreams from My Father*, he recalled how in his youth:

Only Malcolm X's autobiography seemed to offer something different. His repeated acts of self-creation spoke to me; the blunt poetry of his words, his unadorned insistence on respect, promised a *new* and uncompromising *order*, martial in its discipline, forged through sheer *force of will*.

139. <http://www.columbia1968.com/history/>

THE NEW CROW JIM

The New Order (German: Neuordnung) or the New Order of Europe (German: Neuordnung Europas) was the political order which Nazi Germany wanted to impose on the conquered areas under its dominion. The establishment of the New Order had already begun long before the start of World War II, but was publicly proclaimed by Adolf Hitler in 1941: "The year 1941 will be, I am convinced, the historical year of a great European New Order." *Triumph of the Will* (Triumph des Willens) is a filmed record of the 1934 Nazi Party Convention, in Nuremberg. No, it is more than just a record: it is an exultation of Adolf Hitler, who from the moment his plane descends from Valhalla-like clouds is visually characterized as a God on Earth. In his autobiography *WILL* G. Gordon Liddy wrote "Hitler's sheer animal confidence and power of will entranced me. He sent an electric current through my body."

The *Daily Caller* claimed H. Rapp Holder and the other protestors were armed making Holder the first terrorist Attorney General.¹⁴⁰ The "armed," came from a Deleted Web page of the Black Students' Organization (BSO) at Columbia, a successor group to the SAAS. This cached copy was never reproduced by the *Daily Caller*. Contemporary newspaper accounts in *The Columbia Daily Spectator*, a student newspaper, did not mention weapons but how were they to know unless they were long arms.

These, however, were not street Blacks and they knew if they were found with a concealed weapon or became engaged in a shoot out they would go to prison and their career hopes would come to an abrupt end.¹⁴¹

140. <http://dailycaller.com/2012/09/30/as-college-sophomore-eric-holder-participated-in-armed-takeover-of-former-columbia-university-rotc-office/>

141. The FBI stated that records responsive to my request regarding the African American Student Society had been routinely destroyed. FBI referred me to the National Archives and I have filed an FOIA/PA request there.

A. J. WEBERMAN

On the other hand they were serious revolutionaries and the terrorist Weather Underground was spawned by the Student Afro-American Society's sister organization, SDS, Students for a Democratic Society. The only difference between the two organizations was that SDS was White and SAS was Black. This was because the Blacks were Separatists and Supremacists while the White leftists were more inclusive. Were these Blacks going to go the Panther route and shoot it out with the pigs?

THE NEW CROW JIM

1 - Mr. C. W. Thompson
(922 9 & D)
1 - Mr. J. J. Dunn

9/26/68

Airtel

10

To: SAC, New York

From: Director, FBI

STUDENT AFRO-AMERICAN SOCIETY
RACIAL MATTERS

ReNYairtel with enclosed letterhead memorandum (LHM) both dated 9/10/68 captioned "Militant Action by Student Afro-American Society (SAS) at Columbia University, September, 1968, Racial Matters."

Bufiles indicate that captioned organization mentioned in ural 4/25/68 captioned "Students for a Democratic Society, IS - SDS, RM," your file 100-148047.

ReLHM indicated that a reliable source of your office advised that he had received information from a source who was not characterized as to his reliability that at a recent meeting of captioned organization there was a discussion regarding the possibility of firebombing some of the buildings on the campus of Columbia University. According to your LHM, no specific buildings were discussed and no dates were mentioned.

If not already done, an investigation of captioned organization should be initiated to fully determine its aims and purposes and individuals connected therewith. If warranted, separate investigations should be opened regarding leaders and militant members of the group.

MAILED 6
SEP 25 1968
COMM-FBI

Tolson _____
DeLoach _____
Mohr _____
Bishop _____
Casper _____
Callahan _____
Conrad _____
Felt _____
Gale _____
Rosen _____
Sullivan _____
Tavel _____
Trotter _____
Tele. Room _____
Holmes _____
Gandy _____

JJD:ebb
(5)

MCT-35

157-10632-1

20 SEP 26 1968

SEE NOTE PAGE TWO

REC-19

OCT 4 1968

NW 13894 DocId:70000328 Page 2

A. J. WEBERMAN

Airtel to SAC, New York
RE: STUDENT AFRO-AMERICAN SOCIETY

In connection with your investigation, your source should be recontacted to determine if any additional data has been developed regarding the alleged firebombing of buildings on the campus of Columbia University. Insure any data developed regarding possible violence on the part of captioned organization is promptly brought to the attention of local authorities if such action has not been handled by the police.

NOTE:

In April, 1968, captioned group was involved in barricading a building at Columbia University, New York City. New York source involved is a detective on the New York City Police Department who in turn received it from one of his sources. The militant activities of captioned group at Columbia and latest allegation regarding firebombing indicates active investigation should be initiated.

THE NEW CROW JIM

FD-36 (Rev. 5-22-64)

FBI

Date: 9/10/68

Transmit the following in _____
(Type in plaintext or code)

Via AIRTEL _____
(Priority)

TO: DIRECTOR, FBI (157-6-34)

FROM: SAC, NEW YORK (157-892)

SUBJECT: MILITANT ACTION BY STUDENT
AFRO-AMERICAN SOCIETY (SAS)
AT COLUMBIA UNIVERSITY
SEPTEMBER, 1968
RACIAL MATTERS

FOIA(b)(7) - (D)

Enclosed to the Bureau are 8 copies of an LHM on
above matter and confidential source referred to is _____
_____ who in turn received this information
from a confidential source of the NYCPD. For this reason,
_____ identity is concealed and the LHM is
classified "Confidential".

Dissemination of attached LHM is being made to
108th MI Group, OSI, NISO, Secret Service and USA, SDNY.

REC-21 157-10632-2

18 SEP 11 1968

C. C. Bishop

ENCLOSURE

EX-102

RACIAL INT. SECT.

- 3-Bureau (Encls. 8) (RM)
 - 1-New York (100-155132) (AASA) #43
 - 1-New York (100-163465) Student Agitation Columbia University #42
 - 1-New York (157-) Student Afro-American Society) 43
 - 1-New York
- VJA:lmg
(7)

AGENCY: ACSI, ~~OSI~~, OSI, SEC SER
DEPT ISD: CRD, IDIU
DATE FORW: 8/12/68
HOW FORW: R/S
BY: J. L. B.

54 OCT 8 - 1968
Approved: _____
NW: 15894 DocId: 30109228 Page 4

Sent _____ M Per _____

1cc the lhm
copy
copy

Ingrin
C.D. Blyden
Shackelford

A. J. WEBERMAN



UNITED STATES DEPARTMENT OF JUSTICE
FEDERAL BUREAU OF INVESTIGATION

In Reply, Please Refer to
File No. NYfile 157-892

New York, New York
September 10, 1968

~~CONFIDENTIAL~~

Militant Action By Student
Afro-American Society (SAS)
At Columbia University
September, 1968
Racial Matters

A confidential source, who has furnished reliable information in the past, furnished the following information on September 6, 1968, which he in turn received from a source not characterized as to reliability.

Approximately two weeks ago, a meeting of the Student Afro-American Society (SAS) was held in the vicinity of Columbia University, New York City. The group consisted of about fifty Negro students attending Columbia University. These students were apparently some of the Negroes who occupied the Hamilton Hall, Columbia University, during April, 1968, while student demonstrations were taking place at Columbia. The group is a supporter for "black power" and appeared to this source to be very militant in nature.

DECLASSIFIED BY 32193 AM, PDB (KRB/H)
ON 12-27-85

~~CONFIDENTIAL~~

~~GROUP 1~~

~~Excluded from automatic
downgrading and
declassification~~

This document contains neither recommendations nor conclusions of the Federal Bureau of Investigation (FBI). It is the property of the FBI and is loaned to your agency; it and its contents are not to be distributed outside your agency.

NW: 15894 DocId: 70100328 Page 5

157-10632-2
ENCLOSURE

THE NEW CROW JIM

Militant Action By Student
Afro-American Society (SAS)

CONFIDENTIAL

At the above meeting, the SAS discussed the possibility of fire-bombing some of the buildings on the Columbia University Campus. No specific buildings were discussed and no dates were mentioned. It appeared to be understood by those in attendance at the meeting that any militant action such as fire-bombing would take place sometime during the latter part of September, 1968, during school registration for the beginning of classes.

CONFIDENTIAL

-2*

NW: 15894 DocId: 70100328 Page 6

OPTIONAL FORM NO. 10
MAY 1962 EDITION
GSA FPMR (41 CFR) 101-11.6

UNITED STATES GOVERNMENT

Memorandum

1/21/69

TO: *[Handwritten initials]*
FROM: *[Handwritten initials]*
SUBJECT: *[Handwritten initials]*

DIRECTOR, FBI

DATE: 1/20/69

SAC, NEW YORK (157-2519)

CD B. B. [Handwritten]
10

STUDENTS APRO-AMERICAN SOCIETY (SAS)
RACIAL MATTERS

ReNYlet 10/28/68, including LHM also dated 10/28/68.

Enclosed herewith for the Bureau are 11 copies of an LHM relating to the current status of the captioned organization. The sources utilized within are identified as follows:

NY T-1

[Redacted box]

Shaw [Handwritten]

NY T-2

[Redacted box]

FOIA(b)(7) - (D)

[Large handwritten circle]
[Handwritten initials]

NY T-3

[Redacted box]

The enclosed LHM is classified "Confidential" since it contains information from NY T-1, NY T-2 and NY T-3, the unauthorized disclosure of whose identity might have an adverse effect upon the national security interests of the United States.

The information contained herein from was furnished to SA JOHN ROBINSON on the date noted.

2 - Bureau (Encl. 11) (RM)
1 - New York

REC-115

157-10632-4

TEB:jtc
(3)

JAN 21 1969

ENCLOSURE

RACIAL INT. SEC.

AWO: ISB: [Handwritten]
By [Handwritten]



57 FEB 24 1969 Page 14

Buy U.S. Savings Bonds Regularly on the Payroll Savings Plan

THE NEW CROW JIM

~~CONFIDENTIAL~~

Students Afro-American Society
Columbia University, New York City

"It is important that we realize that the distortion of the issues by most of the news media was not a simple mistake. The Columbia University Board of Trustees is a powerful and influential group. It was in the best interest of the administration to arouse sentiment against the demonstrators which was easily accomplished by grouping all under the name of 'left wing radical' or S.D.S. The fact that from the very beginning the administration recognized and respected this separation.

"The demonstration of SAS was organized and efficient. Throughout the occupation of Hamilton Hall its members were orderly and conducted themselves with dignity and respect. There was no destruction of any personal property; all offices and facilities in Hamilton Hall were maintained as we found them. Sanitation and maintenance teams were set up and the building was given a thorough cleaning 3 times a day. Another fact that should be brought out is that the leaders of SAS were calm, responsible Black Students. The members of SAS recognized the gravity of the situation and the momentous proportions of their actions. For this reason they conducted themselves in a manner such that nothing would detract from the rightness of their cause. On the other hand most of SDS were unruly, unclean, and destructive. They constantly yelled extremist doctrines and, in general, conducted themselves in such a fashion that none of the black students cared to be identified with them. To arouse sentiment against the demonstration, however, the news media presented the picture of SDS as representative of the whole demonstration despite all efforts of the Black students.

~~CONFIDENTIAL~~

- 2 -

Like many of the Panthers Holder had an Afro and he might have fashioned himself a mini-Panther.



During Reconstruction in Columbia County, Georgia, armed Klansmen not only intimidated voters but even cowed federal soldiers sent to guard the polling place. Not surprisingly, while 1,222 votes had been cast in Columbia County for Republican governor Rufus Bullock in April 1868, only one vote was cast for Republican presidential candidate Ulysses Grant in November 1868.¹⁴²

Bartle Bull, a former civil rights lawyer and publisher of the left-wing *Village Voice*, witnessed voter intimidation at the dawn of the New Reconstruction Era when the New Black Panther Party pulled the most blatant form of voter intimidation identical to the KKK. It began on Election Day 2008. Bull and others witnessed two Black Panthers in paramilitary garb at a polling place near downtown Philadelphia.¹⁴³ One of them, they say, brandished a

142. <http://www.georgiaencyclopedia.org/articles/history-archaeology/ku-klux-klan-reconstruction-era>

143. <https://www.youtube.com/watch?v=neGbKHGuHU>

THE NEW CROW JIM

nightstick at the entrance and pointed it at voters and both made racial threats. Mr. Bull says he heard one yell "You are about to be ruled by the Black man, cracker!"

The Justice Department, which was headed by lame duck AG Michael Mukasey filed a civil lawsuit against the New Black Panther Party and three of its members, saying they violated the 1965 Voting Rights Act by scaring voters with the weapon, uniforms and racial slurs. Bull submitted an affidavit at Justice's request to support its lawsuit.

When none of the defendants filed any response to the complaint or appeared in federal district court in Philadelphia to answer the suit, it appeared almost certain Justice would have prevailed by default. Instead, the department, now headed by H. Rapp Holder, suddenly allowed the party and two of the three defendants to walk away.

Against the third defendant, Minister King Samir Shabazz, it sought only an injunction barring him from displaying a weapon within 100 feet of a Philadelphia polling place for the next three years—action that's already illegal under existing law. H. Rapp Holder explained why the Panthers walked.

When you compare what people endured in the South in the 1960's to try to get the right to vote for African Americans, and to compare what people were subjected to there to what happened in Philadelphia—which was inappropriate, certainly that...to describe it in those terms I think does a great disservice to people who put their lives on the line, who risked all, for my people.

The behavior wasn't evil it was just "inappropriate." Holder noted that his late sister-in-law, Vivian Malone Jones, helped integrate the University of Alabama.

A. J. WEBERMAN

To compare that kind of courage, that kind of action, and to say that the Black Panther incident wrong thought it might be somehow is greater in magnitude or is of greater concern to us, historically, I think just flies in the face of history and the facts.

In 1961 Vivian Malone Jones applied to the University of Alabama but was turned down because of her race, not because of her grades which were exceptional. President Kennedy had to federalize the Alabama National Guard in order to get her past Governor George Wallace, a segregationist who blocked the entrance to the college. She eventually joined the Civil Rights Division of the Justice Department and had a traditional Black family.

No one was asking H. Rapp Holder to request that Obama mobilize the National Guard to escort Philadelphia voters to the polling booths. No one was even calling for criminal charges. The complaint read:

Defendants New Black Panther Party for Self-Defense, Malik Zulu Shabazz, Samir Shabazz, and Jerry Jackson have engaged in coercion, threats, and intimidation, and attempted coercion, threats, and intimidation of voters, and those aiding voters, in violation of Section 1 l(b) of the Voting Rights Act of 1965, 42 U.S.C. § 1973i (b).

Defendant New Black Panther Party for Self-Defense and Defendant Samir Shabazz avowedly endorse and support racially-motivated violence. Defendant Samir Shabazz has made statements attributed to him in various newspapers supporting violence against non-Black individuals and violence directed toward non-Blacks and Jews. Defendant New Black Panther Party

THE NEW CROW JIM

for Self-Defense is a Black-supremacist organization which uses military-style uniforms, has auxiliary groups such as the "Panther Youth," and is explicitly hostile toward non-Black and Jewish individuals in both rhetoric and practice. Defendant New Black Panther Party for Self-Defense has an active presence in Philadelphia, Pennsylvania, in part through the efforts of Defendant Samit Shabazz.¹⁴⁴

All Mukasey was asking was to punish these thugs for violating the law. But Holder let them walk because he once was a watered-down version of one of them. This was a contemporary event, not ancient history, and could not be compared to the racial turmoil that existed in the 1950's when the Supreme Court headed by Earl Warren, who reportedly never had much association with Blacks¹⁴⁵ ordered the desegregation of America's educational institutions.

Eric Holder was the first Black Panther United States Attorney General and shared their mentality. He was the only USAG who believed that the "pigs" constantly frame brothers for crimes they have not committed. Statistics indicate African American arrest rates for violent crime through the 1990's 45% of arrests nationally are disproportionate to their share of the population which is about 7% of the population. One third of African-American males will end up incarcerated. Are all these men and women being framed? Since Holder is a watered down Black Panther, a house Panther, he believes law enforcement is singling out Blacks not that Blacks might have a proclivity to drugs and crime. Since there is no evil and every Black is a victim of capitalism and racism it came as no

144. Case 2:09-cv-00065-SD Document 1 Filed 01/07/09 Page 1 of 9 IN THE USDC Eastern District of Pennsylvania

145. <http://www.barnesandnoble.com/w/earl-warren-g-edward-White/1101398303?ean=9780199923328>

surprise that Eric Holder didn't believe in calling the cops when some a kid acts up in school so the kid doesn't get a criminal record that follows him through life.

"A routine school disciplinary infraction should land a student in the principal's office, not in a police precinct," Attorney General Eric Holder said.¹⁴⁶ "This guidance will promote fair and effective disciplinary practices that will make schools safe, supportive and inclusive for all students. By ensuring federal civil rights protections, offering alternatives to exclusionary discipline and providing useful information to school resource officers, we can keep America's young people safe and on the right path."

Holder wanted to sacrifice the teacher's safety and that of other students so some little member of the Future Gangbangers of America can get a job as a security guard. Holder also wants to make it easier for Black kids to cop a walk from Juvenile or Family Court. A Justice Department report on St. Louis's Juvenile Court system stated:

The practice of requiring admissions from children who are eligible for informal adjustment is troubling because children who did not commit the act they are accused of, or who may have legal defenses, are nonetheless forced to admit to committing the act or face the risk of prosecution if they refuse. In addition, although statements made during the adjustment process are inadmissible at adjudication hearings, they may be included in the Deputy Juvenile Officer's pre-disposition and certification reports to the Court and, therefore, impact the

146. <http://www.ed.gov/news/press-releases/us-departments-education-and-justice-release-school-discipline-guidance-package-enhance-school-climate-and-improve-school-discipline-policiespractices>

THE NEW CROW JIM

Family Court's decisions. In one of the records we reviewed, for example, a youth's prior informal adjustment was included in the Deputy Juvenile Officer Certification Investigation Report; the Deputy Juvenile Officer ultimately recommended that the youth be certified to be tried in adult court. Moreover, a child's participation in informal adjustment itself signals an admission of wrongdoing, since in the absence of such an admission, the child would not have been permitted to enter the program. This could negatively affect the child if he or she violates the adjustment conditions or is re-arrested, as the Deputy Juvenile Officer's report informs the Court of prior adjustments.

The informal adjustment process is a diversionary mechanism which, if completed successfully, forestalls formal court adjudication. Depending on their prior records of delinquency involvement, children charged with lower-level felonies may be tracked for informal adjustment, along with children charged with misdemeanors and status offenses. According to data provided by the Office of State Courts Administrator, roughly half of the children referred to the Court between June 30, 2012 and June 30, 2014 were tracked for informal adjustment.

Informal adjustment is a form of Juvenile Offender Status where there is no court record of a crime even if it is a serious felony. Holder wants to make sure Informal Adjustment records are not used against a Black who continues to commit crimes because it might negatively impact on the outcome of their cases. All Holder worries about is how to make crime part of America's social fabric, rather than something that destroys it. Then he goes on to say that half the offenders were given Informal Adjustment status. Isn't the leniency enough?

Pretrial Detention. Race has a significant and substantial impact on pretrial detention. Even after controlling for the severity of the offense, the risks presented by the youth and the age of the youth, Black youth have two-and-a-half times (2.50) greater odds of being detained (held in custody) pretrial.

We reached this conclusion after examining the raw statistical data that demonstrated a racially disproportionate impact for Black children, and after controlling for non-racial data, such as age, backgrounds, severity of allegations, and gender. The statistically significant racial disparities we found are unexplainable on grounds other than race and are evidence of racial bias. We conclude that with respect to these aspects of the juvenile court process, St. Louis County violates the rights guaranteed to Black youths under the Equal Protection Clause of the Fourteenth Amendment.¹⁴⁷

The problem with this as you can see from the chart below so many subjective variables were programmed into these statistics that they can be easily manipulated but even then they show that Blacks have a high percentage of criminality and backgrounds that engender it than Whites so of course they are going to have a higher rate of pre-trial detention.

Zero tolerance policies must be reversed. Why? Because crime has become a part of Black culture so to suppress it is racist in the New Reconstructionist Era. Exclusionary policies such as suspension and expulsion must be stopped and the demented violent kids must be kept in class.

147. <http://www.justice.gov/opa/file/641971/download>

THE NEW CROW JIM

**Risk, Allegation, and Individual Characteristics Noted in
St. Louis County Case Records, by Race of Juvenile (2010-2013)**

| Variables | Race of Juvenile | | |
|---|------------------|--------|--------|
| | White | Black | Total |
| Risk Variables | | | |
| Under 15 at First Referral | 31% | 41% | 38% |
| Has Prior Referrals | 31% | 39% | 36% |
| Assault Referrals | 16% | 23% | 21% |
| Prior Out of Home Placement | 14% | 20% | 18% |
| Negative Peer Relationships | 20% | 29% | 26% |
| History of Child Abuse or Neglect | 6% | 9% | 8% |
| Prior Substance Abuse | 21% | 17% | 18% |
| School Attendance or Discipline Problems | 25% | 37% | 33% |
| Ineffective Parental Management | 20% | 31% | 27% |
| Parental Incarceration | 6% | 17% | 13% |
| Risk Score (number of items) | 1.9 | 2.6 | 2.4 |
| Allegation Variables | | | |
| Severity of Allegation* | 15.0 | 22.9 | 20.2 |
| Percent Felony | 10.8 | 16.0 | 14.2 |
| Percent Misdemeanor | 48.3 | 52.1 | 50.8 |
| Percent Infractions or Ordinance | 0.5 | 0.5 | 0.5 |
| Percent Juvenile Offense | 39.1 | 30.0 | 33.2 |
| Demographic Variables | | | |
| Age | 15.1 | 14.8 | 14.9 |
| Gender (Percent Male) | 64.3 | 63.9 | 64.1 |
| Total Number | 11,177 | 20,992 | 32,169 |
| *Measured by the percent of cases with this allegation which were handled by petition process | | | |

In 2014 the U.S. Department of Education and the U.S. Department of Justice, acting together, sent every school district a letter asking local officials to avoid racial bias when suspending or expelling students. District officials were advised that they risk legal action if school disciplinary policies have “a disparate impact, i.e., a disproportionate and unjustified effect on students of a particular race.”¹⁴⁸ The 2015 Nation's Report Card, or National Assessment of Educational Progress (NAEP) recorded the first decline in national math scores of fourth and eighth graders since 1990. This was partially a result of Holder and Obama’s educational policies. Obama got rid of his White Secretary of Education, Arne Duncan, and replaced with Black John B. King Jr. former Commissioner of Education in New York State in another race-based appointment. King was an affirmative action student at Harvard and his having been kicked out of a prominent private school was discounted. King was a proponent of Common Core which was a college oriented curriculum with a lot of testing. Because too many students were getting low scores under Common Core, instead of trying to raise those scores the Department of Education said students should spend no more than 2 percent of their class time taking exams effectively knocking out Common Core.

Prior to the New Reconstruction Era the federal government waded into local court cases only when the outcome directly affected a federal interest, such as national security or diplomacy. Now the Justice Department has filed statements of interest in cases involving Blacks who get legal aid in New York, Black juvenile prisoners in solitary detention in California, and Black people who take videos of police officers in Baltimore.¹⁴⁹

148. <http://educationnext.org/no-racially-disparate-discipline-policies-opposed-by-both-teachers-and-general-public/>

149. <http://www.nytimes.com/2015/08/20/us/justice-dept-presses-civil-rights-agenda-in-local-courts.html>

THE NEW CROW JIM

Holder was a proponent of affirmative action or race based hiring or admission the constitutionality of which is now being determined by the Supreme Court. The University of Texas uses a "10 per-cent plan," in which any student who graduates in the top 10 per-cent of a public high school in Texas is granted admission to the University of Texas. Since many of the state's high schools are largely segregated because of Black crime and disruptive students, the policy increased the number of black students at the university. A White student, Abigail Noel Fisher, who was denied admission in favor of a less qualified Black sued the school. BERT REIN represented Abigail Fisher, GREGORY G. GARRE, ESQ., Washington, D.C.; on behalf of Respondents, the University of Texas, GEN. DONALD B. VERRILLI, JR., ESQ., Solicitor General, Department of Justice, Washington, D.C.; for United States, as amicus curiae, supporting Respondents.

JUSTICE SCALIA: As I understand what you're saying, the Bakke approach -- comparing two individuals and -- and -- and, where they're tied, giving a -- a benefit to one for race -- that's okay. Regardless of whether there are any other means --

MR. REIN: No --

JUSTICE SCALIA: -- of achieving the -- the racial balance that you're looking for. Right?

MR. REIN: Well, Justice Powell indicated in Bakke that that approach could be used where it's part of a greater function form in the class.

JUSTICE SCALIA: Understand. Understand. But --

MR. REIN: And that -- and the Court has --

JUSTICE SCALIA: But you -- you don't --

MR. REIN: -- apparently accepted. We're not challenging it here.

JUSTICE SCALIA: You don't have to apply the question whether it could possibly be done in any other way. But you're saying anything beyond that, anything else; you have to establish first that it couldn't be done another way that doesn't take into account race, such as expanding the 10 -- top 10 percent or the top 15 percent.

MR. REIN: That is correct.

JUSTICE SCALIA: Right?

MR. REIN: And it's not just me, Justice Scalia. That's what this Court said in the prior opinion.

JUSTICE SCALIA: That's what I thought.

MR. REIN: They had -- it has to be shown to be necessary. And of course, that's true of all strict scrutiny. And the Court said in the prior opinion that its other strict scrutiny opinions, such as *Adarand*, were applicable here. This is not detached. It's not different. Strict scrutiny is a heavy burden. There's no question about it. That's why it's strict scrutiny.

Adarand Constructors had submitted the low bid on a subcontract for a federal highway project. Mountain Gravel, the prime contractor, would receive additional federal funds for awarding subcontracts to businesses owned by "socially and economically disadvantaged individuals." Mountain Gravel awarded the contract to a higher bidder on this basis. The government's policy included a presumption that minority-owned businesses were socially and economically disadvantaged.

Issue. Does the Fifth Amendment's guarantee of equal protection require the federal government's racial classifications to withstand strict scrutiny? Yes. Court of Appeals ruling reversed and remanded.

THE NEW CROW JIM

Justice Sandra Day O'Connor (J. O'Connor), writing for the majority, extends the Fourteenth Amendment requirement to the states in *Richmond v. J.A. Croson Co.*, 488 U.S. 469 (1989), to the federal government through the Fifth Amendment. Namely, strict scrutiny is applied to all race-based classification, regardless of benign or remedial motive. You have to have a damn good reason to deprive someone of their constitutional rights but because of a grave injustice long past it is appropriate in certain contexts.

JUSTICE SCALIA: There are -- there are those who contend that it does not benefit African-Americans to -- to get them into the University of Texas where they do not do well, as opposed to having them go to a less advanced school, a less -- a slower track school where they do well. One of -- one of the briefs pointed out that -- that most of the -- most of the black scientists in this country don't come from schools like the University of Texas.

MR. GARRE: So this Court --

JUSTICE SCALIA: They come from lesser schools where they do not feel that they're -- that they're being pushed ahead in -- in classes that are too -- too fast for them.

MR. GARRE: This Court -- This last remark got Scalia in a lot of hot water. He is suggesting there is certain uniformity in the intelligence of African-Americans.

JUSTICE SCALIA: I'm just not impressed by the fact that -- that the University of Texas may have fewer. Maybe it ought to have fewer. And maybe some -- you know, when you take more, the number of blacks, really competent blacks admitted to lesser schools, turns out to be less. And -- and I -- I don't think it -- it -- it stands to reason that it's a good thing for the University of Texas to admit as many blacks as possible. I just don't think -- Mr. Verrilli, do you -- you think all of this won't be necessary in another 13 years -- where we stop disadvantaging some applicants because of their race.

GENERAL VERRILLI: What I think about that is that the -- the Court, I think, made a prediction in -- in Grutter that that would hopefully be the case.

JUSTICE SCALIA: I think that's a -- that's too short term. What do you think --

GENERAL VERRILLI: I think --

JUSTICE SCALIA: -- 30 years?

GENERAL VERRILLI: I think the University's always --

JUSTICE SCALIA: What is it about this program that is going to change things, so that -- so that we can stop classifying people by race?

GENERAL VERRILLI: No. I -- I -- I think the universities do make progress on this, and I think you do get to a point where you create a virtuous cycle. And -- and I think it does work, and I think that there's -- there's -- and -- and I think there's ample reason to -- to believe that it does work. And I think the key point here with respect to compelling interests is that this really is -- in -- in terms of having the educational benefits diversity, that's in the heartland of what the Court has said, is the area in which the University's expertise and experience deserves deference.

MR. GARRE: This Court heard and rejected that argument, with respect, Justice Scalia, in the Grutter case, a case that our opponents have and asked this Court to overrule. If you look at the academic performance of holistic minority admits versus the top 10 percent admits, over time, they -- they fare better. And, frankly, I don't think the solution to the problems with student body diversity

THE NEW CROW JIM

can be to set up a system in which not only are minorities going to separate schools, they're going to inferior schools. I think what experience shows, at Texas, California, and Michigan, is that now is not the time and this is not the case to roll back student body diversity in America. Thank you, Your Honors.

In 1997, Barbara Grutter, a white resident of Michigan, applied for admission to the University of Michigan Law School. Grutter applied with a 3.8 undergraduate GPA and an LSAT score of 161. She was denied admission. The Law School admits that it uses race as a factor in making admissions decisions because it serves a "compelling interest in achieving diversity among its student body." The District Court concluded that the Law School's stated interest in achieving diversity in the student body was not a compelling one and enjoined its use of race in the admissions process. In reversing, the Court of Appeals held that Justice Powell's opinion in *Regents of the University of California v. Bakke*, 438 U.S. 265 (1978), constituted a binding precedent establishing diversity as a compelling governmental interest sufficient under strict scrutiny review to justify the use of racial preferences in admissions. The appellate court also rejected the district court's finding that the Law School's "critical mass" was the functional equivalent of a quota.

In a 5-4 opinion delivered by Justice Sandra Day O'Connor, the Court held that the Equal Protection Clause does not prohibit the Law School's narrowly tailored use of race in admissions decisions to further a compelling interest in obtaining the educational benefits that flow from a diverse student body.

The Court reasoned that, because the Law School conducts highly individualized review of each applicant, no acceptance or rejection is based automatically on a variable such as race and that this process ensures that all factors that may contribute to diversity are meaningfully considered alongside race. Justice O'Connor wrote, "In the context of its individualized inquiry into the possible

diversity contributions of all applicants, the Law School's race-conscious admissions program does not unduly harm nonminority applicants."

Affirmative Action discriminates against Whites and creates a double standard. It is a symptom of White guilt and self hate. No one should be discriminated against even the evil Whites who according to Obama have racism in their DNA. It causes people to become cynical about Black professionals and whether they were an affirmative action professional and really don't belong in the position they are in if America were a true meritocracy. Affirmative Action has had no effect on the Black Criminal Subculture.

Holder was soft on Islamist terrorists. A former al-Qaeda spokesman's guilty plea on terrorism charges was accepted by a judge who initially criticized a provision for a 10-year prison term as too lenient. U.S. District Judge Lewis Kaplan held off approving the plea at a Sept. 19, 2014 hearing in Manhattan.

He expressed concern that Adel Abdel Bary, 54, facing multiple terrorism counts tied to the 1998 bombings of two U.S. embassies in Africa, would serve less than 10 years. Some of the initial charges, related to the 224 people killed in the attacks, carried mandatory life terms.¹⁵⁰

In 2013 the government unsealed charges against a Tunisian citizen named Ahmed Abassi, saying he had come to the United States to develop a network of terrorists and commit acts of terror.

Prosecutors said he had "radicalized" one supposed terrorist and spoken of killing 100,000 people through bioterrorism. But at a hearing in Federal District Court in Manhattan, a prosecutor told a judge that the government was now prepared to allow Mr. Abassi,

150. <http://www.bloomberg.com/news/articles/2014-09-30/u-s-judge-approves-al-qaeda-spokesman-abdel-bary-s-guilty-plea>

27, to plead guilty to two counts that did not involve terrorism. He got a six month sentence.¹⁵¹

In 2014 the Justice Department dropped a long-stalled second criminal prosecution of a former college professor who pleaded guilty to aiding a terrorist group following a high-profile trial in Florida that ended with a muddled verdict almost a decade ago. Federal prosecutors in Alexandria, Va., filed a motion seeking to dismiss a criminal contempt indictment brought in 2008 against former University of South Florida mechanical engineering professor Sami Al-Arian, who was born in Kuwait to Palestinian parents.¹⁵²

Holder has returned to Covington and Burlington, attorneys for the capitalist elite. He did as much damage as he could to Honkie America. Covington and Burlington claims to be a diverse law firm hiring gays and lesbians and those self-mutilators that have their genitals removed or inverted. But its record hiring Blacks is specious judging from the ambiguous language in the awards:

Law 360 "Top 25 Best Law Firms for Black Attorneys" (2015) The list highlights firms that have significantly more Black attorneys than the industry average, particularly at the partner level.¹⁵³

Whether the law firm hires a significant number of Blacks all depends on the industry average which is probably very low.

151. <http://www.nytimes.com/2014/04/30/nyregion/milder-view-of-suspect-in-us-case-on-terror.html>

152. <http://www.politico.com/story/2014/06/sami-al-arian-prosecution-108404.html>

153. <https://www.cov.com/en/news/2015/05/covington-named-to-list-of-top-25-best-law-firms-for-Black-attorneys>

Minority Corporate Counsel Association -- Thomas L. Sager Award (2011) Honored the firm for demonstrated sustained commitment to improving the hiring, retention and promotion of minority and woman attorneys.

This is the Sager award text:

In 2010, more than half of the 85 associates who joined the firm were women and 18 associates were ethnically diverse or lesbian, gay, bisexual, or transgender. In the D.C. office, 55 percent of the 60 new associates were women and 27 percent were ethnically diverse or LGBT. Half the 72 summer associates were women and more than 41 percent were ethnically diverse or LGBT. More than 10 percent of the summer associates were African American.¹⁵⁴

What does ethnically diverse as opposed to African-American mean? I am a Jew? Do I qualify as ethnically diverse? Ten percent of the summer associates – interns – were Blacks. How many were hired by the law firm? Covington and Burlington is a Lilly White, White Collar law firm and is part of the establishment that Holder believes are racist, capitalist pigs so in reality he is Tomin' Fool. In his last full year at Covington in 2008, Holder earned \$2.1 million and another \$2.5 million upon his departure in 2009. Holder bought a \$1.5 million condominium in a residential building at City Center in 2014, a mere few hundred feet from the Covington offices. Holder and Malone still keep a home in Upper Northwest D.C. near American University. Loretta Lynch, on the other hand, lives in a modest dwelling in Brooklyn.

154. <https://www.cov.com/files/Uploads/Documents/Diversity%20-%20%20Thomas%20L.%20Sager%20Award.pdf>

THE NEW CROW JIM

Eric Holder has written to lawmakers on behalf of Uber to argue against the use of fingerprint-based background checks as they consider how to regulate ride-hailing service drivers. A letter from Holder making the case that fingerprint checks are an unfair way to screen job candidates and potentially discriminatory was sent to lawmakers in New Jersey and Chicago. In Uber's home state of California, prosecutors said background checks by the company failed to spot the criminal records of 25 drivers who gave thousands of rides to customers. Once again Holder put the well being of criminals above that of their victims.

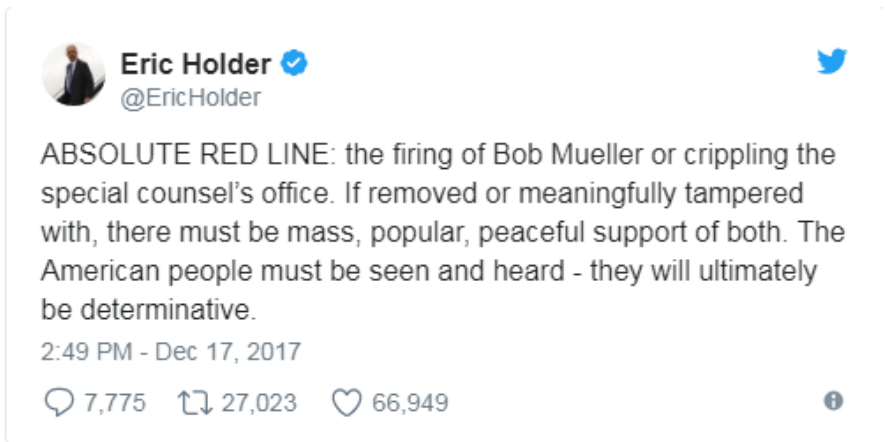

Of course Holder is going to call for peaceful protests knowing that his thug followers are look for an excuse to loot, burn and shoot whites of other thugs they have a prior beef with. The terrorist black nationalist is at it again.

CHAPTER THIRTEEN

MASS INCARCERATION AND THE “NON-VIOLENT” DRUG OFFENDER

After Lincoln was assassinated Andrew Johnson became president. Johnson was a Southerner and a racist. Johnson's vision of Reconstruction was remarkably lenient. Very few Confederate leaders were persecuted. By 1866, 7,000 Presidential pardons had been granted.

The Obama Administration issued 7,000 to pardons to drug dealers doing draconian sentences. But until March 31, 2015 Obama had commuted the sentences of only 21 people and pardoned 64, out of thousands of applications received. On that day he pardoned 21 men for crack and meth and one for marijuana.

FIRST ROUND OF PARDONS (22)

HAROLD KENNETH HERRING, HAVANA, FLORIDA

Possession of a firearm by a convicted felon;
possession with intent to distribute cocaine base.
Sentenced to life imprisonment.

Herrings appeal to shorten his sentence was turned down by a Federal Court of Appeals:

THE NEW CROW JIM

Mr. Herring's challenge to his sentence is plainly wrong on the merits. Mr. Herring had prior convictions in Florida state court for possessing a controlled substance, possessing cocaine, and conspiring to traffic in cocaine. All were felonies. Each was properly counted as a "felony drug offense" under § 841(b) (1) (A).

To be sure, other federal provisions—not including § 841(b) (1) (A)—apply only to prior convictions for drug trafficking offenses or are limited in other respects. Examples include certain guideline provisions and the *Armed Career Criminal Act*. Recent decisions have affected provisions of this kind, and in some respects the law has changed. But § 841(b) (1) (A) applies to any "felony drug offense," not just to offenses that involve trafficking or meet other specific criteria. Mr. Herring's contrary contention is wrong.

Obama's White House press releases constantly repeat the words "non-violent drug offenders." Once someone starts dealing crack they have to protect their cash and their stash. There is no honor among crack dealers. If they became diamond dealers on 47th Street in Manhattan the diamond district would become like the Old West.

DAVID NAVEJAR

David Navejar, Brooksville, Florida. Conspiracy to distribute and to possess with intent to distribute 500 grams or more of methamphetamine. Sentenced to 240 months imprisonment. This is his story: The authorities said they have busted the most prolific meth ring in Pasco County, Florida, history. The organization and its kingpin, Sergio Contreras of Dade City supplied methamphetamines through Hillsborough, Hernando, and Citrus counties.

The ring replaced another one busted last year. In all, the investigation, which combined the efforts of the Florida Department of Law Enforcement, the federal Drug Enforcement Agency and the Pasco County Sheriff's Office, has netted 10 arrests since September, officials said.

Most of them have come in the past three weeks. Authorities said they have seized 5.8 pounds of methamphetamine, which has an estimated street value of \$268,000; 294.5 grams (more than half a pound) of crack cocaine, which has a street value of \$29,000; six vehicles; and four guns. The ring regularly received shipments of 50 pounds of meth and 13 pounds of cocaine from Texas or California, authorities said. David Navejar was one of the men arrested but it is unclear what part he played in the cartel?

LAWRENCE ELMO SCOTT

Lawrence Elmo Scott was convicted of distributing cocaine base (crack) within 1000 feet of a school in violation of 21 U.S.C. § 860(a) (2000), and received a career offender sentence of 283 months imprisonment. U.S. Sentencing Guidelines Manual § 4B1.1 (2002). Scott contends that his sentence constitutes cruel and unusual punishment. We affirm.

Scott was another offender whose motion for a sentence reduction was turned down by my and Appellate Court.

The statutory maximum sentence applicable to Scott's offense was forty years (twice the maximum punishment of twenty years authorized under 21 U.S.C.A. § 841(b)(1)(C)). Scott argues that, ***because the instant offense involved a distribution of .1 grams of crack, his punishment is excessive.***

However, he concedes that harsh sentences for repeat drug offenders have been upheld against similar challenges. See *United States v. Saunders*, 973 F.2d 1354, 1365-66 (7th Cir. 1992). In this circuit, proportionality review is not available for sentences of less than life without parole. *United States v. Ming Hong*, 242 F.3d 528, 532 (4th Cir.), cert. denied, 534 U.S. 823 (2001). We therefore affirm the sentence imposed by the district court. We dispense with oral argument because the facts and legal contentions are adequately presented in the materials before the court and argument would not aid the decisional process. AFFIRMED

Cops often arrange buys near school yards to they can enhance the penalties. This man was a low level crack dealer caught up in the crack hysteria of the 1990's. He deserves his freedom. This is like Jean Val Jean getting life for stealing a loaf of bread.

LIONEL RAY HAIRSTON

In February 1999, pursuant to a written plea agreement, Hairston pled guilty to three counts of distributing cocaine base in the fall of 1998. Each offense involved more than 27 grams of crack cocaine. Hairston also had two previous Virginia felony drug trafficking offenses, one for distributing cocaine and one for possessing cocaine with the intent to distribute, both in violation of Virginia Code § 18.2-248. In 1991, Hairston pled guilty in the Henry County Circuit Court to distributing cocaine and that court sentenced him to seven years imprisonment, with six years suspended, and placed him on probation for five years.

A. J. WEBERMAN

Less than a year later, in 1992, Hairston pled guilty in the Danville Circuit Court to possessing with the intent to distribute cocaine and that court sentenced him to 12 years imprisonment.

A short while later, based on the Danville conviction, the Henry County Circuit Court revoked Hairston's probation on the distribution charge and ordered him to serve six years, with three years to run concurrently with the sentence imposed by the Danville Circuit Court.

This guy is a low level dealer who would have done much less time had the State rather than the Feds busted him.

SECOND ROUND OF PARDONS

JERRY ALLEN BAILEY, CHARLOTTE

On August 14, 1995, Bailey was convicted of Conspiracy to Possess with Intent to Distribute, and Distribute, Cocaine Base (21 U.S.C. §§ 841(a) (1) and 846). At sentencing on April 2, 1996, the Court determined that the Base Offense Level was 38, based on Bailey being responsible for at least 1.5 kilograms of cocaine base. The Total Offense Level, however, was also 38, pursuant to USSG §4B1.1 (b) (*career offender status*). This produced a Guidelines range of 360 months to life imprisonment. The Court imposed a sentence of 360 months' imprisonment.

This is crazy. Thirty years. People do less time for murder. These draconian laws were signed into law by Bill Clinton, who was a criminal himself when he turned the White House into a Whore House.

SHAUNA BARRY SCOTT

THE NEW CROW JIM

YOUNGSTOWN -- In the mid-1990s, Lester Scott and Shauna Barry Scott proclaimed to be anti-drug activists whose Dare to Dream Foundation helped inner-city youth. In 1995 Lester Scott was convicted of a drug charge. In December 1999 he received an 18-month prison sentence based on cocaine possession and illegal use of food stamps. Also in December 1999, his wife received 10 days in jail and four years' probation for perjury and illegal use of food stamps.

In October 2001 the couple crossed paths again with the Youngstown Police Department vice squad and Mahoning Valley Drug Task Force. Officers used a search warrant to enter the Scotts' Elm Street home. After knocking and announcing, "Youngstown police -- search warrant," the officers saw Lester Scott, 41, on a second-floor balcony. When no one answered the door, police forced it open. A search of the balcony turned up bags of crack cocaine in the top of a bottled water dispenser, police said. In a bedroom, crack cocaine was found in a videocassette case, they said. Police said they also found syrup bottles filled with Tussinex, a controlled substance, marijuana in a purse, prescription pills, and 23 separately packaged bags of crack in 39-year-old Shauna Barry Scott's bra.

Lester Scott, who police once said controlled drugs at a North Side housing project, faces charges of trafficking in crack, possession of drugs (Tussinex) and mislabeling of prescription drugs.

A. J. WEBERMAN

Shauna Barry Scott faces charges of trafficking in crack, trafficking in marijuana, possession of marijuana, possession of a dangerous drug (Ultram) and mislabeling of prescription drugs.¹⁵⁵

Lamont Westin, acting as a confidential informant, made buys from the couple with marked money but he disappeared before the couple's trial. The police officer who worked with him testified instead. These two crack dealers were convicted on hearsay evidence.¹⁵⁶

LARRY DARNELL BELCHER

In 1997, Petitioner was convicted by jury in the Western District of Virginia, of (1) possession with the intent to distribute cocaine, in violation of 21 U.S.C. § 841(a) (1); and (2) possession with intent to distribute marijuana in violation of 21 U.S.C. §841(a) (1). Prior to Petitioner's conviction, the Government filed an Information notifying Petitioner that "he is subject to an enhanced mandatory life sentence if convicted...." To establish the enhanced sentence, the ***Government relied on seven prior convictions in the Circuit Court for the City of Martinsville, Virginia, for the sale of cocaine.***

On December 15, 1997, Petitioner was sentenced in the underlying federal criminal case to life imprisonment for possession with intent to distribute cocaine, and to a concurrent 235-month term of imprisonment for possession with intent to distribute marijuana.

155. <http://www5.vindy.com/news/2001/oct/23/youngstown-scotts-to-face-charges-after-police/#sthash.d05QNdFt.dpuf>

156. <http://www.ca6.uscourts.gov/opinions.pdf/07a0758n-06.pdf>

THE NEW CROW JIM

(Response, Exh. 1, Att. 3; see also Response, p. 3 ("Pursuant to 21 U.S.C. [§]841(b)(1)(A) (1994), a defendant convicted of distribution of 50 grams or more of cocaine base, with two prior felony drug convictions, shall be sentenced to a mandatory term of Life imprisonment."))

Okay we get the point. The dude was a crack dealer. But life? This is racism. This is reminiscent of the laws passed against marijuana which were also aimed at Blacks.

JAMES MARION STOCKTON

Offense: Possession with intent to distribute more than five grams of cocaine base; possession of a firearm during and in relation to a drug trafficking offense; possession of a firearm by a convicted felon; possession with intent to distribute cocaine base (Western District of Virginia) Sentence: 420 months' imprisonment; eight years' supervised release (May 27, 2003) Commutation Grant: Prison sentence commuted to expire November 10, 2015.

Moreover, on one occasion, Stockton made inculpatory statements tying himself to a **handgun** found beside a metal tin containing the narcotics under his pillow. Given this evidence, we cannot say that the district court erred in denying Stockton's motion for judgment of acquittal.

KIMBERLY A. WESTMORELAND

Offense: Conspiracy to distribute in excess of 50 grams of cocaine base; carrying a **firearm** in relation to a drug trafficking crime (Southern District of Ohio)

A. J. WEBERMAN

Sentence: 180 months' imprisonment; five years' supervised release (Jan. 21, 2004) Commutation Grant: Prison sentence commuted to expire on November 10, 2015.

DUNNING WELLS

Offense: Unlawful possession of **firearm**; distribution of a quantity of cocaine; possession of a firearm during and in relation to a drug trafficking crime (Middle District of Florida) Sentence: 502 months' imprisonment; six years' supervised release (Feb. 20, 1992) Commutation Grant: Prison sentence commuted to expire on November 10, 2015.

Obama stated that America has spent billions of dollars "Incarcerating people often times who have only been engaged in non-violent drug offenses." He went on to say that the people he was pardoning "were not hardened criminals. But the overwhelming majority had been sentenced to at least 20 years 14 of them had been sentenced to life for non-violent drug offenses."¹⁵⁷ Some of the men Obama pardoned were sentenced under the Career Criminal Act. Obama issued 7,000 pardons. Does he believe all these men have been rehabilitated when there is no rehabilitation in the federal prison system? Does he believe by putting more criminals out on the street you create less crime? Obama can't deal with this contradiction:

157. <https://www.facebook.com/WhiteHouse/videos/10153612224689238/>

THE NEW CROW JIM

Well, first of all, I think it's important to look at the evidence -- and there's some conflicting data, but here's what we know -- that we increased our prison population fourfold from 1980.

And the best social science seems to indicate that, initially, locking up folks who were violent for more certain, longer stretches reduced violence on the streets, but that there was a diminishing return at a certain point and it kind of flattened out. But we just kept on locking folks up without, at that point, it being the main driver of violent crime reductions. And we have seen incredible, historic reductions in crime over the last 20 years.

[There] is a recognition that incarceration is just one tool in how we think about reducing crime and violence and making our communities safe. And if that's the only tool -- if we think we only have a hammer, then everything becomes a nail -- then we're missing opportunities for us to create safer communities through **drug diversion** and treatment, for example, or through more effective re-entry programs, or getting to high school kids or middle school or elementary school kids earlier so that they don't get in trouble in the first place, and how are we resourcing that. Now, obviously, the devil is always in the details here, and there are going to be some disagreements on how successful is drug diversion, and can we, in fact, significantly reduce the prison population if we're only focusing on non-violent offenses *where part of the reason that in some countries -- in Europe, for example -- they have a lower incarceration rate because they also don't sentence violent offenders for such long periods of time.*

Drug diversion programs for non-violent offenders is a joke. Anyone who deals hard drugs in the Black Criminal Subculture has to be armed otherwise he will be chumped off by rival dealers or professional rip off artists.

In October 2015 Tyrone Howard, a PCP dealer with a long rap sheet and an arrest for participating in a shoot out where the major witness was afraid to testify killed a New York City Police Officer six blocks from where I live in Manhattan.

Howard had been placed in a diversion program by Manhattan Supreme Court Judge Edward McLaughlin. Judge McLaughlin, with 30 years on the bench, has seen so much violence perpetrated by the Black Criminal Subculture that he had been inured to it and regarded Tyrone as small potatoes. In the last paragraph Obama suggests that America should also cut down the length of sentences for violent crime.

Will a non-violent offender be violent when he is released due to prison culture? The Catch 22 here is that after spending so many years in prison, which is a house of death, many of these men are going to be violent after they are released. So far there is no indication that any of the men whose sentences were commuted by Obama has been arrested, but it is really early in the game. In 2011 law AB 109, (also known as “prison realignment”) passed in an effort to ease the burden on California’s overpopulated prisons. The new realignment policy allows prisoners convicted of non-serious, non-sexual, and non-violent (known as N-3, or non-non-non) crimes to be shifted into already overcrowded local jails, which often leads to early release. AB 109’s language only takes into consideration the most recent conviction when applying the non-non-non classification. Pleading down to lesser crimes also makes the law less effective. For instance, someone convicted of illegal possession of a weapon could be released under AB 109, when in reality they pleaded guilty to that crime to avoid facing trial for assault with a deadly weapon, a much more serious crime.¹⁵⁸

Thirty-year-old Matthew Warner was arrested for the murder of his three-week-old daughter. After the newborn was reported missing the night before, police discovered the child’s body nearby, in the cab of a pickup truck. He had been released under AB 109.

158. <http://www.ijreview.com/2015/02/246723-california-policy-called-question-newly-released-inmate-murders-19-day-old-daughter/>



Darron Marquis Daniels, left, and Maurice Allen Kelley were arrested in connection with the shooting death 4-year-old Daniel Munoz. Sheriff's records show Kelly was supposed to have a Post Release Community Supervision hearing, which is typically associated with AB109.¹⁵⁹



159. <http://www.sbsun.com/general-news/20150803/suspects-in-highland-shooting-death-of-daniel-munoz-4-plead-not-guilty>

THE NEW CROW JIM

A grand jury in Franklin County, Ohio, returned a 10-count, death-penalty indictment against ex-con, 35-year-old Wendell Callahan, for triple murder. Callahan broke into his ex-girlfriend's apartment and stabbed the three victims, according to a statement issued by Franklin County Prosecutor Ron O'Brien announcing the indictment. Children, ages 7 and 10, were murdered to eliminate them as witnesses in the brutal massacre of their 32-year-old mother. Wendell, convicted crack dealer, was set free to commit this awful crime by his fellow criminal, Obama.¹⁶⁰ Those who lack humanity, have less respect for human life.

Obama ended solitary confinement for minors and for most offenders in the Federal prison system. There are maybe 5 juveniles in federal solitary confinement. The issue here should focus on those 5. If the system is working, those 5 should be the very worst behaved juveniles in the hundreds of federal prisons. I'm going to assume that they are.

That probably means that they have acquired weapons, attacked fellow inmates and correction officers, too. That's what really bad inmates do. They also have probably raped fellow prisoners and they probably smuggle contraband too, because that's what the very worst prisoners do. What other offense they may have committed I can only imagine.

The very worst prisoners know no bounds. Now -- what should we do about solitary confinement of the 5 juveniles who act like this? Their fellow inmates and their correction officers are no doubt petrified about their upcoming release. So whose interests come first -- those of the terrible 5 or everybody else's?

160. <http://nation.foxnews.com/2016/03/07/crack-dealer-freed-early-under-obama-plan-murders-woman-2-kids>

What good does this do? Solitary confinement is for people who commit criminal acts in prison.... So they can just get away with crimes in prison now? Knowing people who've been to prison they would say this puts them at risk. Contrary to popular beliefs, some prison communities actually promote peaceful living/tolerance and if people can act without punishment this would definitely put that peace at risk and endanger the lives of Correction Officers.

Additionally a lot of ex-cons converted to Islam in the joint and might get involved in terrorism as retribution for their excessive, draconian jail time which they did not deserve, or join ISIS. President Obama has commuted the sentences of 98 inmates, the White House announced Thursday.

October 2016 marked Obama's eighth round of commutations that year, bringing him to a total of 872 since taking office more than the past 11 presidents combined. He's commuted the sentences of 688 inmates this year alone. In September House Judiciary Committee Chairman Bob Goodlatte (R-Va.) urged Obama to suspend the program. "An alarming number of offenders whose sentences you have commuted were convicted of possession of a firearm during the commission of a felony," Goodlatte wrote in a letter to the president. He said others were known gang members. "These are clearly not low-level, non-violent drug offenders," the congressman wrote.

CHAPTER FOURTEEN

THE AUTOCRAT



Many democratically elected heads of state in Africa refuse to step down. Obama revealed himself as an African Dictator wanna-be during his WTF interview:

The last thing is that you lose fear. I was talking to somebody the other day about why I actually think ***I'm a better president, and would be a better candidate if I were running again, than I ever have been.*** It's sort of like an athlete. You might slow down a little bit, you might not jump as high as I used to, but I know what I'm doing and ***I'm fearless.*** You're not pretending to be fearless. When you get to that point. Part of that fearlessness is because you've screwed up enough times, that you know it's

all happened. I've been through this. I've screwed up. I've been in the barrel tumbling down **Niagara Falls**.

At this point I was hoping Maron would get up and say "Niagara Falls??!!" and attack Obama as in the Abbott and Costello sketch **Niagara Falls** however this did not go down. Obama has made the remark about being re-elected on at least one other occasion because he has becoming a Black racist dictator in the back of his mind.



Fearless? Obama is the most fearful President yet! He is afraid to fight ISIS, the Taliban and Iran. He had this to say about terrorism:

The same is true when it comes to how we think about the fight against terrorism. You know we ended two wars but I always said from the start there really are people out there who would have no compunctions about blowing up an entire neighborhood of Americans innocent men women and children for **ideological** reasons.

THE NEW CROW JIM

We have to deal with that. And that then means we do have to be able to identify those networks when we can find *those folks* and try to prevent them from doing what they are doing and so for the last six and half years I have been trying to do is build up a legal structure that is consistent with our values, with due process and build up an intelligence system that is consistent with our civil liberties and sometimes my supporters will write and say ah you know there is some stuff here that you are doing that is just like Bush And what I explain to them the problems with the excesses of our counter-terrorism approach after 9/11 were real and water boarding and torture and renditions were stopped but that doesn't mean that we don't have real problems out there and there aren't balances that we have to strike and figure out and its complicated and we have to mindful that whatever abstract views you have about drones or that you have about intelligence gathering that if you were sitting there in the situation you'd realize that you got some responsibilities and some choices to make and it's not all clear cut the way often times it gets presented. Yeah it's like middle management. Sometimes your job is just to make stuff work. Sometimes the task of government is to make incremental improvements or try to steer the ocean liner two degrees north or south so that ten years from now suddenly were are in a very different place than were but at time but at the moment people may feel like we need a 50 degree turn we don't need a 2 degree turn and you say well to yourself if I turn 50 degrees the whole ship turns 50 degrees and you can't turn 50 degrees it not just because of

A. J. WEBERMAN

corporate lobbies it's not because of big money it's because society's don't turn 50 degrees, democracies certainly don't turn 50 degrees and that's been true on issues of race, issues of the environment, issues of discrimination as long as we are turning in the right direction and making progress government it working the way it supposed to.

Obama's policies are making it more difficult to fight terrorism by limiting the options in the name of civil liberties. When the stakes involve Atomic, Biological or Chemical weapons it is worth sacrificing some privacy. Why worry about the NSA determining who you are calling unless you are involved in terrorism or criminal activity? ISIS wants to destroy America not for ideological political reasons but for religious ones but Obama refuses to say it because he once prayed at a Mosque. Obama is steering the country not to the North or South but to the far Left. Finally why does Obama call the terrorists "folks?"

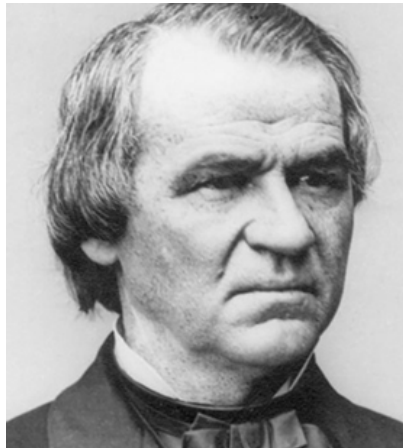

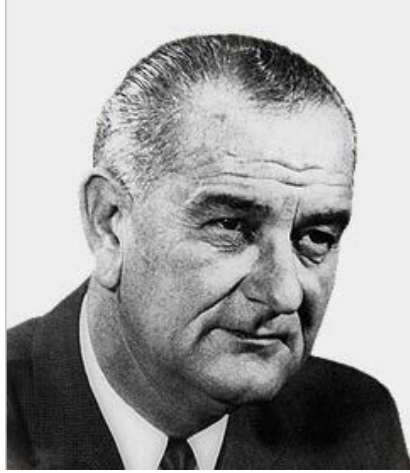

President Andrew Johnson made it clear that he was the absolute ruler of his administration's policy, and he did not defer to Congress or hesitate to use his presidential veto power or his ability to issue executive orders. The Whigs established in 1834 as a reaction to the authoritarian policies of Andrew Jackson claimed to be defending popular liberties against the autocratic Jackson, who was referred to in negative cartoons as "King Andrew I."

Just as Johnson was a White racist autocrat during Reconstruction, Obama is a Black racist autocrat during the New Reconstruction. Obama's Executive Orders weaken the power of Congress and make America more of an autocracy than a democracy. This is exacerbated by America's two-party, rather than Parliamentary, system. According to his toady Leon Panetta, despite the fact he served as a Senator, Obama never really had much respect for Congress. And Obama has nothing but praise for African autocratic dictators like Prime Minister Hailemariam of Ethiopia. Obama:

Likewise, our host, Ethiopians have much to be proud of -- I've been amazed at all the wonderful

work that's being done here -- and it's true that the elections that took place here occurred without violence.¹⁶¹

It has been relatively recently in which the Constitution that was formed and elections put forward a democratically elected government. And we are opposed to any group that is promoting the violent overthrow of a government, including the government of Ethiopia that has been democratically elected.¹⁶²

Hailemariam's ruling party and its allies achieved a clean sweep in May 2015 election, winning all 546 parliamentary seats. The elections were condemned by human rights groups as a sham. The government made it hard for opposition candidates to register, raise money and mobilize supporters, according to watchdog groups. Peaceful protesters were denied permits, harassed and in some cases arrested. News organizations were shut down and reporters harassed, threatened or arrested.

American diplomats were denied accreditation as election observers and prohibited from formally observing the process, according to the State Department, and the only international observers on the ground were from the African Union. The State Department said at the time that it was "troubled" that Obama opposition party observers were barred from some locations.¹⁶³

161. <https://www.Whitehouse.gov/the-press-office/2015/07/28/remarks-president-obama-people-africa>

162. <https://www.Whitehouse.gov/the-press-office/2015/07/27/remarks-president-obama-and-prime-minister-hailemariam-desalegn-ethiopia>

163. <http://www.nytimes.com/2015/07/28/world/africa/obama-calls-ethiopian-government-democratically-elected.html>



Obama also visited Kenya the land of half his DNA. He joked about the stupidity of the birthers and met with Uhuru Kenyatta, a mass murderer who had been indicted by the International Criminal Court in connection with post-election ethnic violence in 2007-08.

Before Obama made the visit charges were dropped against Kenyatta. The prosecutor's office said the Kenyan government had refused to hand over evidence vital to the case. Kenyan Foreign Minister Amina Mohamed said her government would try to have two other similar cases thrown out including one involving Deputy President William Ruto. Prosecutors said the evidence had "not improved to such an extent that Mr Kenyatta's alleged criminal responsibility can be proven beyond reasonable doubt". Kenyatta was the first head of state to appear before the court, after he was charged in 2012.¹⁶⁴

The prosecution repeatedly asked for more time to build its case, saying witnesses had been bribed and intimidated, and the Kenyan government had refused to hand over documents vital to the case.

164. <http://www.bbc.com/news/world-africa-30347019>

Human Rights Watch had accused the Kenyan government of acting as a roadblock and "impairing the search for truth." About 1,200 people were killed in the violence in 2007-8 and 600,000 were displaced. Ironically Jomo Kenyatta, Uhuru's father, persecuted Barak Obama Sr. after Obama's return to Kenya, Blacklisting him and making it impossible for him to find work.¹⁶⁵ Obama's African trip highlighted the fact the Africans and Democracy don't often mix.

The General Accounting Office stated that Obama violated the law in his zeal to release Islamist detainees by not serving notice to Congressional Committees:

The Department of Defense (DOD) violated section 8111 of the Department of Defense Appropriations Act, 2014 when it transferred five individuals detained at Guantanamo Bay, Cuba, to the nation of Qatar without providing at least 30 days notice to certain congressional committees.

Section 8111 prohibits DOD from using appropriated funds to transfer any individuals detained at Guantanamo Bay unless the Secretary of Defense notifies certain congressional committees at least 30 days before the transfer.

As a consequence of using its appropriations in a manner specifically prohibited by law, DOD also violated the Anti-deficiency Act.¹⁶⁶

165. <http://www.cnn.com/2015/07/25/politics/obama-kenyatta-kenya-fathers/>

166. <http://www.gao.gov/products/B-326013>

THE NEW CROW JIM

Thirty five percent of the detainees released from GITMO return to making jihad. These high profile prisoners were exchanged for an American soldier who was later charged with desertion. This exchange gave Obama an opportunity to negotiate with terrorists without congressional approval. He was pleased with the results and with an executive order, Obama made it legal to negotiate with terrorists and indirectly pay ransom demands.

The White House

Office of the Press Secretary

For Immediate Release June 24, 2015

Presidential Policy Directive -- Hostage Recovery Activities

PRESIDENTIAL POLICY DIRECTIVE/PPD-30

SUBJECT: U.S. Nationals Taken Hostage Abroad and Personnel Recovery Efforts

This Presidential Policy Directive (PPD), including its classified annex, supersedes and revokes, along with Annex 1 and Appendix A to NSPD-12, dated December 4, 2008. The policy directs a renewed, **more agile** United States Government response to hostage-takings of U.S. nationals and other specified individuals abroad

NSPD-12, United States Citizens Taken Hostage Abroad, dated February 18, 2002 is classified as are its two annexes. One declassified line reads:

The United States Government remains committed to the safe and rapid recovery of private Americans and United States Government personnel taken hostage or isolated overseas and to bringing to justice and punishing individuals or groups responsible for illegally capturing or holding such persons against his or her will.

There was no mention of paying ransoms after negotiating with terrorists in this paragraph. What this earlier national security policy directive is probably about are military options.

What does more agile mean in Obama's revision? It means more flexible willing to pay ransom. Why the use of "hostage-taker" instead of kidnapper? Because kidnapping arouses a visceral response while "hostage-taker" does not since it is rarely used. This should give you some idea of how Obama wants to make palatable to the public policies that might end in their falling prey to kidnapping and death.

PRESIDENTIAL POLICY DIRECTIVE / PPD-30 also reaffirms the United States Government's personnel recovery policy, which seeks to **prevent, prepare for,** and respond to hostage-takings and other circumstances in which U.S. nationals are isolated from friendly support. This policy will thereby further important national security and foreign policy interests by strengthening the protections for U.S. nationals outside the United States.

"Prevent" the only way to prevent kidnapping is to infiltrate terrorist and criminal groups abroad. This is the already the job of the CIA. "Prepare for and respond" the only way to prepare for a kidnapping is to have money ready to pay the ransom. "From US nationals who are isolated from friendly support." In other words, this refers to kidnapping victims whose families are forbidden to pay Ransom under current US Intelligence Directives. "Strengthening the protections for U.S. nationals outside the United States."

How could paying ransom's to kidnappers protect Americans? Common sense dictates that if the kidnapper is

THE NEW CROW JIM

successful others will do the same. Obama knows it will weaken protections for those who have NOT be kidnapped and the next part of this document reads:

The United States will use every appropriate resource to gain the safe return of U.S. nationals who are held hostage. But the United States Government will make no concessions to individuals or groups holding U.S. nationals hostage. It is United States policy to deny hostage-takers the benefits of ransom, prisoner releases, policy changes, or other acts of concession. This policy protects U.S. nationals and strengthens national security by removing a key incentive for hostage-takers to target U.S. nationals, thereby interrupting the vicious cycle of hostage-takings, and by helping to deny terrorists and other malicious actors the money, personnel, and other resources they need to conduct attacks against the United States, its nationals, and its interests.

It sounds like Obama is taking a tough line and reversely what was intimated in the first paragraph of the directive. But here is the catch:

However, this policy does not preclude engaging in communications with hostage-takers. For example, when appropriate the United States may assist private efforts to communicate with hostage-takers, whether directly or through public or private intermediaries, and the United States Government may itself communicate with hostage-takers, their intermediaries, interested governments, and local communities to attempt to secure the safe recovery of the hostage.

What are the communications with hostage-takers going to be about? The price of tea in China? They are going to be about money or a prisoner exchange. Obama is a liar.

The United States Government will lead international efforts to counter, marginalize, and deter hostage-taking by increasing the costs to hostage-takers and eliminating the benefits of hostage-taking. This shall **include engagement with foreign governments**, international organizations, and other relevant nongovernmental organizations to encourage them to adopt and implement **no-concessions policies** and statements and to seek commitments to defeat and punish hostage-takers and their aiders and abettors.

Again the pendulum swings in the other direction. Now America is going to convince countries like France that ransom the nationals, not to do it. Once the US starts paying ransoms and trading prisoners other countries will follow suit or continue to engage in this appeasement of evil. This reasoning is illogical.

When considering how to respond to a hostage situation, the United States Government shall undertake **those options that are most likely to secure the hostage's safe release**; deter future hostage-taking of U.S. nationals and combat the financing of terrorist and other criminal enterprises; and protect other U.S. national security interests.

First in priority comes securing the hostages safe release, not financing terrorist organizations is third. Those options that are most likely to secure the hostage's safe release might include paying terrorists off which means financing a war against your own country.

THE NEW CROW JIM

Obama is turning high government and intelligence community officials into traitors, financing an enemy dedicated to destroying the United States and making it part of a Caliphate.

The Hostage Recovery Fusion Cell shall serve as the United States Government's dedicated interagency coordinating body at the operational level for the recovery of U.S. national hostages abroad. The Hostage Recovery Fusion Cell shall: (1) **identify and recommend hostage recovery options and strategies to the President through the NSC**; (2) coordinate efforts by participating departments and agencies to ensure that information regarding hostage events, including potential recovery options and engagements with families and external actors (to include foreign governments) is appropriately shared within the United States Government to facilitate a coordinated response to a hostage-taking;

How is the Hostage Recovery Fusion Cell going to make its recommendations as to who lives and who dies? The Tea Party went off on a tangent with Death Panels but the Hostage Recovery Fusion Cell is a real one. Is the panel going to try to talk the price down? Is there going to be an EBay like hostage-taker website with a Buy Now and Best Offer button? This is how the directive ends:

The United States Government remains committed to the safe and rapid recovery of private Americans and United States Government personnel taken hostage or isolated overseas and to bringing to justice and punishing individuals or groups responsible for illegally capturing or holding such persons against his or her will.

What does *isolated overseas* mean? “Illegally capturing?” Obama again using a euphemism for kidnapping to hide the fact he is going to deal with them.

The White House
Office of the Press Secretary
For Immediate Release June 24, 2015
Executive Order -- Hostage Recovery Activities

EXECUTIVE ORDER

HOSTAGE RECOVERY ACTIVITIES

By the authority vested in me as President by the Constitution and the laws of the United States of America, I hereby direct as follows:

Section 1. Purpose. The 21st century has witnessed a significant shift in hostage-takings by terrorist organizations and criminal groups abroad. Hostage-takers frequently operate in unstable environments that challenge the ability of the United States Government and its partners and allies to operate effectively. Increasingly, hostage-takers target private citizens -- including journalists and aid workers -- as well as Government officials. They also utilize increasingly sophisticated networks and tactics to derive financial, propaganda, and recruitment benefits from hostage-taking operations.

The unstable environments Obama is referring to are the Islamic State and Syria. In this world anybody's ass is up for grabs.

The United States is committed to securing the safe recovery of U.S. nationals held hostage abroad and deterring future hostage-takings by denying hostage-takers any benefits from their actions. Because such hostage-takings pose unique challenges, the United States Government must be organized and work in a coordinated effort to use all instruments of national power to achieve these goals consistent with the United States Government's ***no concessions policy.***

So what is the sense of established a Hostage Recovery Fusion cell if Americas no concessions policy remains in effect?

Establishing a single United States Government operational body to coordinate all efforts for the recovery of U.S. nationals taken hostage abroad, with policy guidance coordinated through the National Security Council, will increase the likelihood of a successful recovery, ***allow for enhanced support to hostages and their families,*** promote foreign policy and national security interests abroad, and enhance the prospects of successful criminal prosecutions of hostage-takers. Dedicating a senior diplomatic representative to operate in support of this coordinated effort will further enhance the potential for the safe recovery of hostages.

This Executive Order is to allow families to ransom hostages held by Islamists. It is not at all consistent with ***the United States Government's no concessions policy.*** How is Obama going to reconcile the two?

Obama is going to establish a Hostage Recovery Fusion Cell which would make exceptions to the no ransom policy then advise

the families on how to obtain the ransom money from private citizens, CIA proprietary's, NGO's, and CIA sponsored Foundations. This has to be the case because a situation might arise where one family can afford the ransom and another cannot. If the person from the poorer background gets murdered and the one from the richer background is freed there would be a great public outcry.

Sec. 2. Establishment and Responsibilities of the Hostage Recovery Fusion Cell. (a) The Attorney General, acting through the Director of the Federal Bureau of Investigation (FBI), shall establish within the FBI for administrative purposes an interagency Hostage Recovery Fusion Cell (HRFC). (b) The following executive departments, agencies, and offices (agencies) shall participate in the Hostage Recovery Fusion Cell: (i) the Department of State; (ii) the Department of the Treasury; (iii) the Department of Defense; (iv) the Department of Justice; (v) the Office of the Director of National Intelligence; (vi) the FBI; (vii) the Central Intelligence Agency; and (viii) other agencies as the President or the Attorney General, acting through the Director of the FBI, from time to time, may designate.

What has the Department of the Treasury have to do with terrorist hostage taking abroad if not to supply ransom money? Having all these agencies involved will only confuse things. Alphabet soup!

(c) The Hostage Recovery Fusion Cell shall have a Director, who shall be a full-time senior officer or employee of, or detailed to, the FBI.

The Hostage Recovery Fusion Cell shall also have a Family Engagement Coordinator and other officers or employees as appropriate. The head of each participating agency shall, to the extent permitted by law, make available for assignment or detail to the Hostage Recovery Fusion Cell such personnel as the Attorney General, acting through the Director of the FBI and after consultation with the head of the agency, may request. Such personnel so detailed or assigned will operate utilizing the clearances provided by their respective agencies.

The Family Engagement Coordinator will work out the details of paying the ransom and insuring the kidnapers don't pull a double cross and kill their hostage.

(d) Pursuant to policy guidance coordinated through the National Security Council, the Hostage Recovery Fusion Cell shall:

(i) Identify and ***recommend hostage recovery options*** and strategies to the President through the National Security Council.

In other words approve the ransoming of hostages or disapprove and they get decapitated on YOUTUBE.

(ii) coordinate efforts by participating agencies to ensure that information regarding hostage events, including potential recovery options, ***engagements with families and external actors (including foreign governments), is appropriately shared within the United States Government to facilitate a coordinated response to a hostage-taking;***

If the family decides to pay ransom the government must be kept informed and the family and the government will work together to make sure the terrorists keep their part of the deal. Since the families and the Feds would be working together there will be no criminal prosecutions. Instead the families would be advised where to get the ransom money indirectly from the U.S. Government.

(iii) Assess and track all hostage-takings of U.S. nationals abroad and provide regular reports to the President through the National Security Council on the status of such cases and any measures being taken toward the hostages' safe recovery; Re-evaluate already existing cases and see if a payoff can be made to the terrorists or criminal syndicates to get the hostage released.

(vi) ***Make recommendations to agencies in order to reduce the likelihood of U.S. nationals being taken hostage abroad*** and enhance United States Government preparation to maximize the probability of a favorable outcome following a hostage-taking.

This is newspeak out of George Orwell. If kidnappers are paid will this discourage them from doing more kidnappings? Of course not! Obama capitulates to Islam time and time again and with this Executive Order he becomes one of their major funders.

(vii) coordinate w/ agencies regarding congressional, media, and other public inquiries pertaining to hostage events.

In other words keep the negotiations with terrorists secret so there would be no public outcry.

Sec. 3. Establishment of the Hostage Response Group. (a) There shall be a Hostage Response Group (HRG) chaired by the Special Assistant to the President and Senior Director for Counterterrorism, to be convened on a regular basis and as needed at the request of the National Security Council to further the safe recovery of U.S. nationals held abroad.

The Hostage Response Group may also be tasked with coordinating the United States Government response to other hostage-takings occurring abroad in which the United States has a national interest, as specifically referred to the Hostage Recovery Fusion Cell by the Deputies Committee.

(b) The regular members of the Hostage Response Group shall include the Director of the Hostage Recovery Fusion Cell, the ***Hostage Recovery Fusion Cell Family Engagement Coordinator***, and senior representatives from the Department of State, Department of the Treasury, Department of Defense, Department of Justice, FBI, Office of the Director of National Intelligence, and other agencies as the President, from time to time, may designate.

What is the difference between the Hostage Response Group and the Hostage Recovery Fusion Cell? The Hostage Response group will coordinate military operations against kidnapers. The phrase “from time to time” appears in the CIA’s charter and is a reference to the CIA’s mandate to carry out assassinations.

A. J. WEBERMAN

(c) The Hostage Response Group, in support of the Deputies Committee chaired by the Assistant to the President for Homeland Security and Counterterrorism, and consistent with the process outlined in Presidential Policy Directive 1 or any successor, shall:

(i) Identify and recommend hostage recovery options and strategies to the President through the National Security Council, as consistent with Presidential Policy Directive 30 of June 24, 2015 (U.S. Nationals Taken Hostage Abroad and Personnel Recovery Efforts);

(ii) Coordinate the development and implementation of U.S. hostage recovery policies, strategies, and procedures, consistent with the policies set forth in Presidential Policy Directive 30;

(iii) receive regular updates from the Hostage Recovery Fusion Cell on the status of U.S. nationals being held hostage abroad and measures being taken to effect the hostages' safe recovery;

(iv) coordinate the provision of policy guidance to the Hostage Recovery Fusion Cell, including reviewing recovery options proposed by the Hostage Recovery Fusion Cell and working to resolve disputes within the Hostage Recovery Fusion Cell; and

(v) where higher-level guidance is required, make recommendations to the Deputies Committee.

Signed BARACK OBAMA

THE NEW CROW JIM

This group will settle disputes within the Hostage Recovery Cell as to the efficacy of paying ransoms or trying a rescue operation.

There are more signs of autocracy: The United States Supreme Court unanimously rejected the administration's power grab on recess appointments by making clear it could not decide when the Senate was in recess. In January 2014, Dinesh D'Souza was indicted by federal prosecutors for campaign finance law violations. D'Souza was an author who became an anti-Obama filmmaker scoring a huge hit with the film 2016: *Obama's America*. The film claimed that Obama's presidency was solely dedicated to the cause of diminishing America's power abroad. His sentence was reminiscent of Soviet style punishment for dissidents behind the Iron Curtain. The Feds claimed they discovered his crime during a routine audit of political candidates and their contributors. Judge Richard Berman agreed. The following is from D'Souza's *Motion for Dismissal* on the basis of selective prosecution:

There is good reason for concern that the defendant in this case was selectively targeted for felony prosecution because of his outspoken vigorous and politically controversial criticism and condemnation of President Barack Obama and his administration.

Indeed, there is nothing about how this case has been handled, which even suggests that it proceeded in the traditional manner in which virtually all other campaign finance investigations are investigated and routinely resolved without referral for criminal prosecution.

Simply put, the timing in which the D'Souza case moved from campaign filings to formal FBI investigation and indictment is startling by itself

when compared to all other comparable cases, when the funds involved are minimal and when there is no evidence whatsoever of official corruption or candidate involvement.

In addition, the manner in which the government has resisted all efforts and inquiries from counsel for D'Souza and the *Senate Judiciary Committee* to determine "why" this case was singled out for criminal prosecution further suggests that the reasons for the prosecution may well have involved a prohibited selective process.¹⁶⁷

This is what Senator Jeff Sessions (Republican Alabama) discovered about the D'Souza prosecution:

About the D'Souza campaign contribution case. I see there was a conviction. He pled guilty to a count. I think that it appeared from the beginning he probably violated, and he gave money to a campaign above the limits by moving monies through other persons. I don't think he ever really fully denied that and neither did his lawyer. But my question is, we would like some specific answers about that case because looking at the data that we've seen from 2004 through 2006, not a single charge was made under that statute. And from 2007 to 2013, only 24 were charged under that statute, which roughly is about three a year over the last seven years. I've never seen his movie but this was an individual known the challenge the President. There seems to be no corrupt financial dealings involved in this

167. *USA v. Dinesh D'Souza*, 1:14-cr-00034, in the U.S. District Court SDNY

contribution and I want to know more about how he turned out to be the one that got charged. Did you personally review that indictment before – reviewed the referral of that case for indictment before it occurred.

FBI Director James Comey: No not necessarily.

Sen. Jeff Sessions: Well in the Department of Justice you know the guidelines say that you have to ask Washington's approval even at the local level involving someone of high profile.

Comey: I can't remember exactly but it's not about profile. It's about members of the media, elected officials, that sort of this.¹⁶⁸

There is no doubt that the D'Souza prosecution was politically motivated. The initial question is why the FBI was interested in a relatively small campaign donation that lacked any evidence of corruption and why the FBI did not refer the case to the FEC for a civil resolution, which more often than not are how these cases proceed. Another thing that troubles this researcher is how they made the connection between the straw contributors and D'Souza. All the information they had was a name and address of the contributor. You don't have to write an autobiography to make a campaign contribution. So these agents are going through names and see Mr. X and Mr. Y. How did they know they were friends of D'Souza? What connected them to him?

It was the old story of illegal surveillance, which could not be used in court as evidence; leading to evidence that could be admitted. These questions remain unanswered, despite specific inquiry by counsel for D'Souza and the Senate Judiciary Committee.

168. <http://www.whatthefolly.com/2014/05/28/transcript-sen-jeff-sessionss-qa-w-fbi-director-james-comey/>

What really pissed Obama off was when D' Souza brought Obama's younger half brother into the mix. D'Souza's attorney explained: "During the same time period, also in the fall of 2010, Mr. D' Souza started the "George Obama Compassion Fund" to assist Obama's half-brother, George Obama, who was at the time apparently living in a hut in a Huruma slum of Nairobi, Kenya. Mr. D'Souza personally donated his own money to the fund and also publicly encouraged others to donate as well. George Obama was then contacted by the White House officials who pressured George Obama not to accept money from D'Souza."

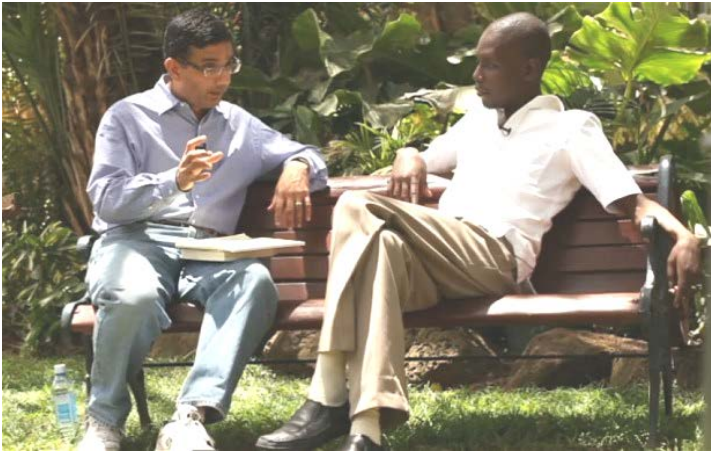

In May 2014, D'Souza pleaded guilty to one felony count of making illegal contributions in the names of others. In September 2014, the court sentenced D'Souza to 5 years probation, 8 months in a community confinement center, and \$30,000 fine. He is also required to perform a day (eight hours) of community service each week during his probation and must undergo psychological counseling on a weekly basis.

D'Souza attended a meeting of the American Renaissance Party and did an expose on these racist swine.¹⁶⁹

169. http://www.amren.com/news/2005/02/the_washington/

THE NEW CROW JIM

The IRS made it difficult for Tea Party organizations to obtain non-profit status in order to politically repress them. Lois Lerner was Obama's henchwoman. When she was called before Congress she took the Fifth.

I have not done anything wrong. I have not broken any laws. I have not violated any IRS rules or regulations and have not provided false information to this or any other congressional committee. While I would very much like to answer the committee's questions today, I've been advised by my counsel to assert my constitutional right not to testify or answer questions related to the subject matter of this hearing. After very careful consideration, I've decided to follow my counsel's advice and not testify or answer any of the questions today. Because I'm asserting my right not to testify, I know some people will assume I've done something wrong. I have not. One of the basic functions of the Fifth Amendment is to protect innocent individuals and that is the protection I'm invoking today. Thank you.¹⁷⁰



170. <http://www.fednews.com/>

J. Russell George is part of a cover up. He at first he believed there was deliberate destruction of evidence by Lerner but Obama and Holder put the screws to him and he ruled there was no targeting of the Tea Party by the IRS. Following his nomination by President George W. Bush, the United States Senate confirmed J. Russell George in November 2004, as the Treasury Inspector General for Tax Administration. A native of New York City, he attended public schools including Brooklyn Tech High School. George received his Doctorate of Jurisprudence from Harvard University's School of Law. After receiving his law degree, he returned to New York and served as a prosecutor in the Queens County District Attorney's Office. In October 2015 the Justice Department, under another African-American named Loretta Lynch, failed to bring criminal charges against Lois Lerner.

TRUMP REVERSES OBAMA'S EXECUTIVE ORDERS

Sept. 5: Trump rescinds the Deferred Action for Childhood Arrivals.

Aug. 29: Trump reversed a rule requiring large companies to report worker pay by race and gender in order to decrease the wage gap through greater pay transparency. (Chicago Tribune)

Aug. 28: Trump reversed an order banning the transfer of some surplus military equipment to police departments.

Aug. 25: Trump signed an order banning transgender troops to serve in the US military, reversing Obama-era reforms.

Aug. 15: Trump rescinded a flood-risk rule in response to climate change. The rule was intended to insure safer placement of roads, bridges and other infrastructure out of new areas prone to flooding because of sea level rise and increased precipitation. Trump reversed the rule to speed up the approval process for projects.

July 3: The Trump administration contested a Obama administration rule qualifying more people to get overtime pay by doubling the minimum salary a worker must make to qualify for a management exemption to \$47,000. (Los Angeles Times)

THE NEW CROW JIM

June 16: Trump outlined a hard-line policy on Cuba, in direct opposition to Obama's efforts to foster friendlier relations with the communist government of President Raul Castro. (Washington Post)

June 1: Trump 'quits' the Paris Climate Treaty, adopted by Obama in an executive order last year. (New York Times)

May 14: Senate voted to repeal Obama-era regulation that restricted drug-testing for job seekers receiving unemployment benefits. (Politico)

April 28: Trump signed an executive order aimed at expanding offshore oil and gas drilling in the Arctic, Atlantic, and possibly Pacific Ocean, scrapping another facet of Obama's environmental legacy. (Washington Post)

April 27: Trump directed the Interior Department to reconsider safety regulations for offshore drilling put in place after the 2010 BP oil spill in the Gulf of Mexico. The executive order was intended to roll back Obama administration attempts to ban drilling off the southeastern Atlantic and Alaskan coasts. (New York Times)

April 26: Trump signed an executive order giving the Interior Department the power to whittle down or abolish some national monuments, which would effectively reverse Obama's creation and expansion of national monuments during his term of office. (NPR)

April 13: Trump revokes an Obama administration rule protecting funding for Planned Parenthood and other organizations that provide legal abortions. (NPR)

March 28: Trump rescinded Obama's clean energy plans, which put a cap on greenhouse gas emissions by power plants. (New York Times)

March 27: Trump rescinded Obama's 2014 Fair Pay and Safe Workplaces meant to apply 14 labor and civil rights laws to federal contractors, who now will no longer have to provide documentation of their workplace practices. (Forbes)

March 27: Trump signed bills overturning two Obama-era education regulations, including required programs training new teachers and the Every Student Succeeds Act intended to hold schools accountable for student performance. (Washington Post)

A. J. WEBERMAN

Feb. 28: Trump rolled back Obama's Clean Water Rule, intended to increase the scope of waterways regulated for pollutants. (Washington Post)

Feb. 23: The Trump administration withdrew protection for transgender students to use the bathrooms and facilities corresponding to their gender identity. (CNN)

Jan. 23: Trump withdrew from the trans-pacific Partnership, a trade deal between the US and countries on the Pacific Rim. (Washington Post)

Jan. 20: Trump signed his first executive order seeking prompt repeal of the Affordable Care Act – which to date has not happened. (New York Times)

CHAPTER FIFTEEN

IMMIGRATION



Obama:

A child on the other side of the border is no less worthy of love and compassion than my own child. We can't distinguish between in terms of their worth and inherent dignity, and that they're deserving of shelter and love and education and opportunity.

This is easy for Obama to say "open the borders" from safety of his **8.1 million dollar** Washington, D.C. home.¹⁷¹

¹⁷¹ https://www.nytimes.com/2017/05/31/us/obama-buys-house-washington-kalorama.html?_r=0



OBAMA PLANS TO HOUSE MEXICAN CHILDREN HERE

This America Last Policy resulted in Obama flooding America with illegal aliens via his policy of catch and release. The Obama administration made it so that illegal immigrants frequently received notices to appear (NTA) in court and were subsequently released into the public. The then-acting chief of the Border Patrol, Ronald Vitiello, testified before a Senate committee that up to 55 percent of Mexican illegal immigrants with a notice to appear before a judge never show up in court. This practice was only partially ended by the Trump Justice Department.

ALERT FOR LAWFUL PERMANENT RESIDENTS WITH CRIMINAL RECORDS CONSIDERING APPLYING FOR UNITED STATES CITIZENSHIP by NYSDA Immigrant Defense Project [Revised June 26, 2003]

When a lawful permanent resident applicant for citizenship with a criminal record might be placed in removal proceedings:

AGGRAVATED FELONY DEPORTABILITY: A lawful permanent resident who applies for United States citizenship may be placed in

THE NEW CROW JIM

removal proceedings (with virtually no possibility of obtaining relief from removal from an Immigration Judge) if he or she has been convicted of one of the following "aggravated felony" crimes:

-- Murder, rape, or sexual abuse of a minor (including not only such NY felony offenses but possibly also NY misdemeanor sexual abuse involving a minor)

-- Illicit trafficking in a controlled substance (including NY felony drug sale offenses, and possibly also including NY felony drug possession offenses, as well as misdemeanor sale ***or second or subsequent misdemeanor possession offenses***)

-- Illicit trafficking in firearms or destructive devices, or in explosive materials

-- Certain specified money laundering offenses or unlawful monetary transaction offenses PLUS ***amount of funds involved exceeded \$10,000***

-- Certain specified offenses relating to explosive materials or firearms

-- A crime of violence ***PLUS sentence of imprisonment of at least one year***

-- A theft offense (including receipt of stolen property) or a burglary offense ***PLUS sentence of imprisonment of at least one year***

-- Certain specified ransom-related offenses

-- Certain specified child pornography offenses

-- Certain specified racketeering or gambling offenses

A. J. WEBERMAN

-- An offense that relates to the owning, controlling, managing, or supervising of a prostitution business OR certain specified offenses relating to prostitution, peonage, slavery, and involuntary servitude

-- Certain specified national security offenses

-- An offense that involves fraud or deceit ***PLUS loss to the victim(s) exceeds \$10,000 OR an offense that is described in section 7201 of the Internal Revenue Code of 1986 PLUS revenue loss to the Government exceeds \$10,000***

-- Certain specified alien smuggling offenses

-- Certain specified illegal entry or reentry offenses

-- Certain specified passport or document fraud offenses ***PLUS sentence of imprisonment of at least 12 months***

-- Failure to appear for service of a criminal sentence ***if the underlying offense is punishable by a term of imprisonment of at least 5 years***

-- Commercial bribery, counterfeiting, forgery, or trafficking in vehicles the identification numbers of which have been altered, ***PLUS sentence of imprisonment of at least one year***

-- Obstruction of justice, perjury or subornation of perjury, or bribery of a witness, ***PLUS sentence of imprisonment of at least one year***

-- Failure to appear to answer to or dispose of a charge of a felony ***for which a sentence of at least 2 years' imprisonment may be imposed***

THE NEW CROW JIM

Since most felonies never go to trial but get bargained down to misdemeanors even if you possess heroin, launder money less than \$10,000, commit a crime of violence, receive stolen property, commit fraud less than \$10,000, forge a passport you can still stay in the United States under New York State law.

DREAMERS

Was Obama's Executive Order on the dreamers, the children of illegal immigrants brought here through no fault of their own and in school and not in any gang, too far reaching? Judge Andrew Hanen, a United States District Court Judge in Texas, thought so. He also believed that not only did Obama overstep his constitutional authority with the order legalizing dreamers; he also thought that the Justice Department overstepped its authority and tried to bamboozle the judge.

The Government claims that the reason its lawyers were not candid with the Court was that they either "lost focus on the fact" or that somehow "the fact receded in memory or awareness." [Doc. No. 242 at 18]. The Government's brief admits that its lawyers, including the lawyers who appeared in this Court, knew that the Defendants were granting three-year DACA renewals using the three-year period created by the 2014 DHS Directive at issue in this case. Yet the Government's lawyers chose not to tell the Plaintiff States or the Court. In fact, the Justice Department knew that DHS was implementing the three-year renewal portion of the 2014 DHS Directive weeks before its attorneys told this Court for the very first time that no such action was being taken. Apparently, lawyers, somewhere in the halls of the Justice Department whose identities are

unknown to this Court, decided unilaterally that the conduct of the DHS in granting three-year DACA renewals using the 2014 DHS Directive was immaterial and irrelevant to this lawsuit and that the DOJ could therefore just ignore it. [Doc. No. 242 at 17].

Then, for whatever reason, the Justice Department trial lawyers appearing in this Court chose not to tell the truth about this DHS activity. The first decision was certainly unsupportable, but the subsequent decision to hide it from the Court was unethical.¹⁷²

Trump has been in power for a month and has not reversed this Deferred Action for Childhood Arrivals EO.

The hard-line white nationalists like Bannon still regard Hispanics as beaners and don't want White jobs going to them. Trump will get around to them sooner or later.

Aside from usurping Congressional power, Obama's immigration executive action had far reaching consequences if it is held to be constitutional. Eventually those granted amnesty will be given citizenship and be beholden to the Democratic Party. Aside from punishing the Whites for racism the idea is to change the demographics of America so the Democrats will remain in power forever. Obama knows he is screwing White Americans and stated:

I know some worry immigration will change ***the very fabric*** of who we are, or take our jobs, or stick it to middle-class families at a time they already feel they've gotten a raw deal for over a decade. I hear those concerns, but that's not what these steps

172. <http://www.scotusblog.com/wp-content/uploads/2016/05/Judge-Hanen-ethics-ruling-5-19-16.pdf>

would do.¹⁷³

Obama has done more than any other United States president to ***change the fabric*** of American society to his skin color and race. Just as Whites have dog whistle terms African-American racists have theirs. One of them is “fabric,” which means *race* or *skin color*. That is why Black racists constantly make references to *changing the fabric of society*. After the *fabric* changes everything is not going to be equal: it will be the Whites who will suffer as they get pay back for centuries of racism that they had no part in. As Bob Dylan put it in *Subterranean Homesick Blues* “lookout kid it’s something you did / God knows when but you’re doing it again.”

Obama formulated a fabric changing work around that entailed forcing minorities to vote:

Maybe the single biggest change that we could make in our political process that would reduce some of the polarization, make people feel more invested and restore integrity to the system is just make sure everybody is voting. Australia has got mandatory voting. If you start getting 70 or 80 percent voting rates, that’s transformative.

This is merely a way to circumvent the constitution which gives rural self sufficient yeomen more of a say in things than city dwellers.

This is what Obama wants to do: “change the very fabric of who we are” from White to Brown and Black. When Blacks hear *fabric* they know what it means. Obama knows he is breaking the law and grabbing power from Congress by doing what he did when he issued his Executive Order on Immigration:

173. <https://www.Whitehouse.gov/the-press-office/2014/11/20/remarks-president-address-nation-immigration>

Obama: *Well, I think as— as you know— and I’ve said this before to you, Jose, but— I’m not a king. You know, my job as the head of the executive branch ultimately is to carry out the law. And when it comes to enforcement of our immigration laws we’ve got some discretion. We can prioritize what we do. But we can’t simply ignore the law.*

To sort through all the possible cases of everybody who might have a sympathetic story to tell is very difficult to do. This is why we need comprehensive immigration reform. To make sure that once and for all in a way that is ratified by Congress, *we can say that there is a pathway to citizenship for people who are staying out of trouble, who are trying to do the right thing, who’ve put down roots here.*

It is gonna be tough. They’re gonna have to pay a fine. They’re gonna have to pay back taxes. Background checks. You know, learning English. They’ve gotta work hard to achieve this incredible privilege of being a U.S. citizen. And it may take some time. But the point is there should be certainty for them that if they do these things they can achieve it. *What we don’t want is I think a vague promise that somewhere down the line maybe sort of kinda you may be able to achieve citizenship. We wanna give people clarity about how they can move forward.*

JDB: Mr. President, will the record number of deportations continue even if there is some serious progress on immigration reform on Capitol Hill? Will these deportations continue the same level that we’ve seen under your administration?

Obama: *Well, look– I’ve said this before and I’ll say it again. My job is to carry out the law. And so Congress gives us a whole bunch of resources. They give us an order that we’ve gotta go out there and enforce the laws that are on the books. And we’ve done so. And we’ve done so effectively. And I make no apologies for us enforcing the law as well as the work that we’ve done to strengthen border security. As a consequence we’ve actually seen an 80% drop in illegal crossings. **And what we’ve seen is that the people who are being deported, the vast majority of them now are criminals.** That did not used to be the case. But there’re still obviously gonna be people who get caught up in the system.*¹⁷⁴

What Holder and Obama did was to make it easier for illegal alien criminals to remain in the United States by allowing “sanctuary cities” to exist. The San Francisco Sheriff’s Department, like nearly all local California jurisdictions and many nationwide, has stopped complying with U.S. Immigration and Customs Enforcement requests that immigrant inmates be held beyond their release dates for pickup and potential deportation. This policy allowed the illegal alien Juan Francisco Lopez-Sanchez who had been deported, imprisoned, deported and imprisoned numerous times to kill a tourist visiting San Francisco.

San Francisco’s sheriff defended his release saying federal authorities failed to provide legal basis to continue to hold him. Such a request from ICE was denied in his case. He had been transported to San Francisco on order of the San Francisco Sheriff’s Department from a Victorville federal prison where he was completing his sentence for his most recent illegal entry into the United States.

174. <https://www.Whitehouse.gov/blog/2014/12/11/excerpts-president-obamas-telemundo-and-univision-interviews>

In 2010 the Justice Department made an astonishing statement about its unprecedented lawsuit to stop the Arizona illegal-immigration law. Eric Holder's spokeswoman, Tracy Schmalzer, claimed that it was appropriate to go after Arizona, but inappropriate to stop "sanctuary cities." Schmalzer said:

There is a big difference between a state or locality saying they are not going to use their resources to enforce a federal law, as so-called sanctuary cities have done, and a state passing its own immigration policy that actively interferes with federal law. That's what Arizona has done in this case.¹⁷⁵

In 1996, Congress prohibited sanctuary cities in no uncertain terms: A "local government entity or official may not prohibit, or in any way restrict, any government entity or official from sending to, or receiving from, the Immigration and Naturalization Service information regarding the citizenship or immigration status, lawful or unlawful, of any individual (8 USC Sec. 1373(a)." But H. Rapp Holder decided he was just going to ignore the law thereby encroaching on the power of Congress.

Now Obama is continuing to break down the rule of law by not punishing those who broke it by illegally entering this country but rewarding them for it. This should come as no surprise if you know his hidden agenda. Anyone with any common sense knows Obama is leading America down the path of demagoguery and racial dictatorship.

The mid-term elections were a repudiation of America's first African-American president after White voters realized they had elected a racist president determined to sacrifice the lives of Whites

175. <http://articles.latimes.com/2010/jul/25/nation/la-na-immigration-sanctuary-20100725>

on the altar of immigration. In 2005 the Government Accounting Office reported:

At the federal level, the number of criminal aliens incarcerated increased from about 42,000 at the end of calendar year 2001 to about 49,000 at the end of calendar year 2004--a 15 percent increase. The percentage of all federal prisoners who are criminal aliens has remained the same over the last 3 years--about 27 percent. The majority of criminal aliens incarcerated at the end of calendar year 2004 were identified as citizens of Mexico. We estimate the federal cost of incarcerating criminal aliens—Bureau Of Prison's cost to incarcerate criminals and reimbursements to state and local governments under SCAAP--totaled approximately \$5.8 billion for calendar years 2001 through 2004.

BOP's cost to incarcerate criminal aliens rose from about \$950 million in 2001 to about \$1.2 billion in 2004--a 14 percent increase.¹⁷⁶

Another manifestation of Obama's plan to change the fabric of America is the election of Donald Trump. "When Mexico sends its people," Trump said during his presidential announcement, "they're not sending the best. They're not sending you, they're sending people that have lots of problems and they're bringing those problems. They're bringing drugs, they're bringing crime. They're rapists and some, I assume, are good people, but I speak to border guards and they're telling us what we're getting."

176. <http://www.gao.gov/products/GAO-05-337R>

A. J. WEBERMAN

How would the border guards know the criminal records of the Mexicans they are apprehending? They have no access to Mexican police data bases nor does Mexico have access to those in the United States. Trump is the Great White Hope.

CHAPTER SIXTEEN

OBAMA'S RACIALIST AND PC HIRING PRACTICES



During the New Reconstruction Period the White House is filled with unqualified and violent appointees. The Emperor Obama's imperial retinue is based on race and gender. This can have disastrous consequences. For example there was a breakdown in security in the United States Secret Service after it was transferred from the Treasury to the Homeland Security Department. Obama and Jeh Johnson appointed a female to head the Secret Service and Obama had female Secret Service agents guarding him in order to be politically correct. But political correctness almost came home to roost for Emperor Obama when Omar "Speedy" Gonzales leaped over the White House Fence, made it through bushes judged to be impenetrable by the United States Secret Service and sprinted through the front door of the White House. Speedy made it much farther into the building than previously known, ***because he overpowered one female Secret Service officer.***

The Officer stationed inside the White House near the Portico doors, seated in a chair next to a window, heard unintelligible noise on her radio. She looked out the window and saw the Officer right outside next to a pillar with his gun drawn.

The Officer did not hear the activation of the emergency communication system and was unaware that the system at her post was muted. Realizing that she was in an emergency situation, she got up from her chair to close and lock the North Portico doors. She was able to close both doors, but Gonzalez barged through them and knocked her backward before she could lock them.

The Officer gave Gonzalez verbal commands and attempted to alert the Joint Operations Center via her radio. Ignoring her commands, Gonzalez walked past the Officer toward the East Room. After attempting twice to physically take Gonzalez down but failing to do so because of the size disparity between the two, the Officer then attempted to draw her baton but accidentally grabbed her flashlight instead. The Officer threw down her flashlight, drew her firearm, and continued to give Gonzalez commands that he ignored. Gonzalez entered the East Room briefly and then began walking back down the hallway toward the grand piano located on the State Floor.¹⁷⁷

Speedy looked like he was unarmed to the USSS but was found to be carrying a knife. The USSS believed the White House door was locked but it was not and never did let the dogs loose on Speedy!

177. <http://chsdemocrats.house.gov/SiteDocuments/20141113173420-75418.pdf>

THE NEW CROW JIM

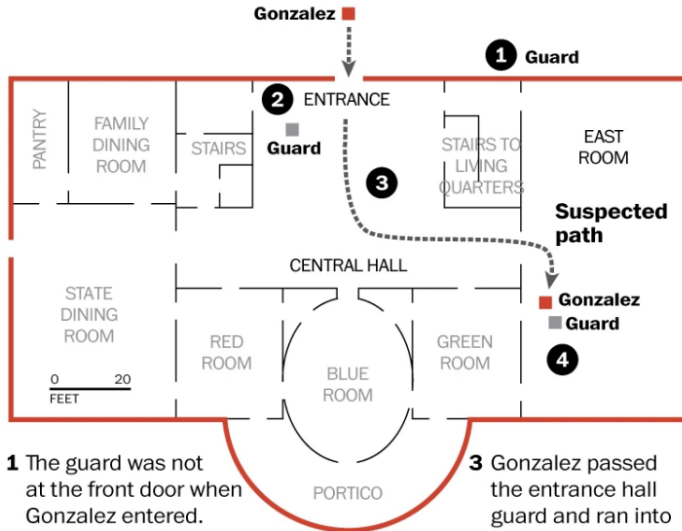

- 1** The guard was not at the front door when Gonzalez entered.
- 2** An alarm box that would have alerted the guard inside was muted.
- 3** Gonzalez passed the entrance hall guard and ran into the East Room.
- 4** Gonzalez was tackled in the East Room.

Returning to Speedy Gonzalez: How did Speedy get as far in as he did? An alarm box near the front entrance of the White House designed to alert guards to an intruder had been muted at a request of the usher's office.¹⁷⁸



178. http://www.washingtonpost.com/politics/White-house-fence-jumper-made-it-far-deeper-into-building-than-previously-known/2014/09/29/02efd53e-47ea-11e4-a046-120a8a855cca_story.html

This was because the head of the White House Ushers, Angella Reid, was hired because she was female and African-American, not because of any other qualifications. Reid was born in Saint Thomas Parish, Jamaica, and attended high school in Kingston, Jamaica, before immigrating to the United States. The White House commented on her appointment:

Angella Reid currently is General Manager at The Ritz-Carlton, Pentagon City, Arlington, Virginia. Previously, she served in management positions at The Ritz-Carlton properties in Miami, Florida and Washington, D.C. Before her tenure with Ritz-Carlton, Reid was General Manager at the Hartford Marriott Rocky Hill Hotel in Connecticut and Director of Operations at the Renaissance New York Hotel in New York City. Reid holds a degree in Hospitality Management from the Carl Duisberg Gesellschaft School in Munich, Germany and is conversational in German and basic Spanish.¹⁷⁹

She is clearly unqualified for the job. JDO is not saying she wanted the alarms muted so she could smoke a spliff and listen to Bob Marley, she had no security background. Look at the qualifications of her predecessors. Rear Admiral Stephen W. Rochon is the former Director of the Executive Residence and White House Chief Usher. Admiral Rochon served his last day on active duty with the Coast Guard on March 9, 2007, and began his service at the White House on March 12.¹⁸⁰

Admiral Rochon succeeded Gary Walters, who retired in January 2007 after 20 years as White House Chief Usher. He

179. <https://www.Whitehouse.gov/the-press-office/2011/10/04/White-house-announces-new-chief-usher-angella-reid>

180. https://en.wikipedia.org/wiki/Stephen_W._Rochon

THE NEW CROW JIM

resigned as Chief Usher in 2011 to work in the United States Department of Homeland Security and was replaced as Chief Usher by Angella Reid on October 5, 2011.

Who knows what Speedy Gonzales had in mind for Obama? Wow. What if Obama was there and was stabbed to death? Talk about chickens coming home to roost!

Then there was the case of another deranged man Oscar Ramiro Ortega-Hernandez shooting a few rounds into the White House and getting away? The gunman parked his Black Honda directly south of the White House. He pointed his semiautomatic rifle out of the passenger window, aimed directly at the home of the president of the United States, and pulled the trigger.

A bullet smashed a window on the second floor, just steps from the Obama's formal living room. Another lodged in a window frame, and more pinged off the roof, sending bits of wood and concrete to the ground. At least seven bullets struck the upstairs residence of the White House, flying some 700 yards across the South Lawn.¹⁸¹ President Obama and his wife were out of town on that evening of Nov. 11, 2011, but their younger daughter, Sasha, and Obama's mother-in-law Marian Robinson, were inside.

Secret Service officers initially rushed to respond. *One, stationed directly under the second-floor terrace where the bullets struck, drew her .357 handgun and prepared to crack open an emergency gun box.* Snipers on the roof, standing just 20 feet from where one bullet struck, scanned the South Lawn through their rifle scopes for signs of an attack.

181. http://www.washingtonpost.com/politics/secret-service-stumbled-after-gunman-hit-White-house-residence-in-2011/2014/09/27/d176b6ac-442a-11e4-b437-1a7368204804_story.html

With little camera surveillance on the White House perimeter, it was up to the Secret Service officers on duty to figure out what was going on. Then came an order: “No shots have been fired. Stand down,” a supervisor called over his radio. He said the noise was the backfire from a nearby construction vehicle.

By the end of that night, the agency had confirmed a shooting had occurred but wrongly insisted the gunfire was never aimed at the White House. Instead, Secret Service supervisors theorized, gang members in separate cars got in a gunfight near the White House’s front lawn, an unlikely scenario in a relatively quiet, touristy part of the nation’s capital.

But wait a cotton pickin’ minute. The shots were fired just above the female Secret Service Agent’s head and she didn’t start a flap when her Supervisor said it was first from backfire and then from gang bangers? Gang bangers? In front of the White House? If this bullshit comes from the Secret Service maybe they don’t have their hearts into protecting an African American? This is implying that the Obama family has turned the White House into a housing project because they tipped the hood when they moved in? African-American voters have been asking their representatives if racism on the part of the Secret Service could be responsible for the lapses in security. In January 2015 shots were fired at Joe Biden’s house and the perpetrator at this time is unknown to the USSS.

This comes after numerous blotto Secret Service agents were hiring hookers during trips abroad. Even the Agent in Charge of investigating the whoring, David Nieland, was a john.¹⁸² However he claimed he was doing an investigation of hookers just as Peter Townsend claimed he was investigating child pornography when caught with it on his computer.

182. <http://www.foxnews.com/politics/2014/10/29/investigator-in-secret-service-prostitution-scandal-resigns-after-implicated-in/>

THE NEW CROW JIM

After Julia Pierson, the female head of the USSS, stepped down and Joe Clancy took over not much changed. On March 4, 2015 two senior Secret Service agents, including a top member of the president's protective detail, drove a government car into White House security barricades after drinking at a late-night party. Officers on duty who witnessed incident wanted to arrest the agents and conduct sobriety tests but the officers were ordered by a supervisor on duty that night to let the agents go home. Video of the incident was destroyed. **Clancy never lowered the boom.** Why this sudden downturn in the morality of the Secret Service? Could it be the racially motivated hiring practices with more minority agents? Or is it gender driven? Or it could be that with a "negro" President the USSS has adopted what it believes to be the morality of the "negro" or in former Secretary of Agriculture Earl Butz's words: "I'll tell you what the coloreds want. It's three things: first, a tight pussy; second, loose shoes; and third, a warm place to shit."

Table 2: Rate of Sexual Harassment and Sexual Misconduct Allegations by Population

| | Employees | Total Offenses | Rate by Population |
|------|-----------|----------------|--------------------|
| ATF | 4,719 | 51 | 10.8 |
| DEA | 11,053 | 136 | 12.3 |
| FBI | 35,344 | 343 | 9.7 |
| USMS | 5,602 | 91 | 16.2 |

Sources: Component misconduct case files and annual reports.

Michele Leonhart, who served as head of the DEA since 2007 resigned after an inspector general's report documented a series of episodes in which agents hired prostitutes.¹⁸³ DEA Agents had sex parties with some women hired by Colombian drug cartels and received Rolex watches from them even though they deserved Patek Philippe.

183. <https://oig.justice.gov/reports/2015/e1504.pdf>

Continuing investigations by the Office of the Inspector General into DEA Task Force Officer Foster Gene John (Michele Leonhart's husband now retired) assorted misuse and abuse of authority while employed in the Los Angeles County Sheriff's Department continues. Here are some of the cases the IG Report covered:

CLARENCE THOMAS JR.

Case #1: A FBI line supervisor, an Assistant Section Chief, a Section Chief, and an Assistant Director failed to report a Supervisory Management and Program Analyst's (SMAPA) repeated unprofessional behavior, including cornering his subordinates in their cubicles and ***displaying the size of his genitals by tightening his pants***, making graphic and inappropriate sexual comments and gestures, and otherwise creating a hostile work environment.

US MARSHALL HAD HOOKERS ANSWERING HIS TELEPHONE

Case #2: A United States Marshall Service supervisor failed to promptly report allegations that a Deputy U.S. Marshal (DUSM) solicited prostitutes while on an extradition mission in Bangkok, Thailand. According to the case file, the supervisor learned about the allegations when the DUSM's colleague reported the matter to management. At that time, the supervisor met with the DUSM; the DUSM admitted the misconduct and received an oral admonishment.

This dude was caught because when his boss called his hotel room one of the two Thai hookers he had entertaining him answered the telephone.

SEX WITH FUGITIVES “WIFE”

Case #3: An Acting Supervisory Deputy U.S. Marshal (SDUSM) reported to district executive management allegations that a DUSM had an inappropriate relationship with *the common law spouse* of a fugitive. However, the Acting Chief Deputy U.S. Marshal, other district executive management, and a representative of the Office of General Counsel (OGC) failed to report these matters to OPR-IA and instead counseled the DUSM.

Common law spouse equals baby mom.

THE CASE OF THE GLORY HOLE

Case #4: In November 2009, an ATF Director of Industry Operations (DIO) who holds a Top Secret security clearance was on temporary assignment. According to the IAD report of investigation, the DIO solicited consensual sex with anonymous partners and modified a hotel room door to facilitate sexual play. In addition, the DIO removed smoke detectors from the hotel room and inadvertently caused damage to the hotel’s centralized fire detection system. When the hotel supervisor contacted the local police, the DIO admitted the conduct and told local police this type of conduct was not an isolated incident for him and had occurred in the past. The DIO pled guilty to one count of misdemeanor “fire prevention interference.” The DIO was placed on inactive probation for 12 months and was ordered to pay a fine and court costs. The incident received significant media attention in the local area.

A. J. WEBERMAN

This is by far the most bizarre, perverted case of all. “The DIO solicited consensual sex with anonymous partners and modified a hotel room door to facilitate sexual play.” He set up his own “glory hole” by drilling a hole in the door and had men he did not know stick their penises through it so he could give them a blow job. “In addition, the DIO removed smoke detectors from the hotel room and inadvertently caused damage to the hotel’s centralized fire detection system.” He was smoking pot while he was doing this or between penises. More turmoil:

Shirley Sherrod, a former USDA official, was forced to resign from her position in 2010 after a conservative blogger published a video of her questioning whether to help a White man losing his farm since so many Black people lost their farm before him.

Desiree Rogers the first African-American White House Social Secretary had to resign because she was totally incompetent and let two party crashers attend an Obama event. Katherine Archuleta who helped get Obama the Hispanic vote resigned as head of the Office of Personnel Management because of a massive data 2015 data breach. All were race-based appointments.



THE NEW CROW JIM

Aside from incompetence violent African Americans have become part of Emperor Obama's court like "Barfetta" Singletery:

On August 7, 2015 at approximately 0230 hours the victim Reginald Cleveland received a text from the defendant Barvetta Singletery asking him to come to her residence at 13800 Burnished Wood Court Upper Marlboro, Prince George's County, for sexual intercourse. Once the victim arrived at the defendant's house they engaged in a *brief sexual encounter* at which time the defendant began asking the victim about another female that he was dating. The defendant asked the victim to step outside of the residence and they walked to the victim's Cadillac Escalade parked out front. The defendant entered the front driver's seat and asked the victim where his cell phones were. After the victim refused to tell the defendant where his phones were, the defendant reached in his bag and retrieved both cell phones and the victim's .40 caliber Glock 23 service weapon. The victim is an officer with the US Capitol Police Department. The defendant exited the truck and ran towards her residence. The victim followed the defendant into her residence and pleaded with her to return his weapon. The defendant demanded the passwords to the victim's phones and he refused. The defendant pulled the Glock handgun out of its holster and pointed it at the victim. The defendant stated, "You taught me how to use this, don't think I won't use it." The defendant racked the handgun discharging an unused bullet from the weapon. The defendant walked to the kitchen table and sat down as the victim sat on the couch approximately 10 feet from her.

The defendant again demanded the passwords to the victim's cell phone. When he refused she asked him, "Your phone is more important than me holding this gun on you?" ***The defendant pointed the gun in the direction of the victim, still seated on the couch, and fired one round.*** The victim, fearing for his life, attempted to gather his belongings and eventually fled the residence. The defendant was observed wiping the gun down with a towel. The victim called 911 and patrol officers arrived on scene placing the defendant in custody without incident.

It would seem that Singletary should be charged with attempted armed robbery, attempted murder, and assault with a deadly weapon, assault on a law enforcement officer, and theft of government property would appear to be just some of the charges she should be facing. But since she is part of the New Reconstruction Era she was only charged with domestic violence.

CHAPTER SEVENTEEN

JEH CHARLES JOHNSON

At one time in our history the three top law enforcement officials in the United States identified as African-American. These were appointments based on race not merit and have had serious consequences for America. Holder's replacement was also African-American but much more traditional than Holder. Research reveals Secretary Jeh Johnson was appointed on the basis of race and furthering a political agenda, not merit.



JOHNSON AND HIS WIFE DR. SUSAN DIMARCO

The *New York Times* reported:

The Justice Department has ordered the FBI to take a new look at evidence used to convict a former immigration official imprisoned for conducting illegal searches of Hispanic-owned businesses in Washington

Heights, senior law-enforcement officials in New York said. Jeh Johnson, a former assistant attorney under Mr. Obermaier, who is now at the law firm of Paul Weiss, Rifkind, Wharton & Garrison, confirmed that FBI investigators had questioned him about the case and that they indicated that they also planned to re-interview witnesses in response to Mr. Molinari's charges that they committed perjury.

"Occhipinti and his supporters have been making this bogus claim for over a year," Mr. Johnson said. "But they have never presented these witnesses to the judge who tried the case or the United States Attorney." In response to the charge that many of the witnesses were drug dealers who doubled as bodega owners, Mr. Johnson said: "That's pure nonsense put out by the Occhipinti propaganda machine." He said that none of the witnesses had any convictions for narcotics, and that, in any case, 7 of the 36 witnesses called by the prosecution were law-enforcement officers who testified that Occhipinti had denied the store owners their civil rights.

The charges against Occhipinti centered on his actions during the course of Project Bodega, an operation devised to investigate allegations that a Dominican drug cartel was using bodegas in Washington Heights to smuggle in aliens. Joseph Occhipinti's lawyers produced 55 audio tapes that supplied evidence that the witnesses who testified against him were in fact engaged in criminal activities and that the allegations lodged against Joseph Occhipinti were part of a deliberate conspiracy by

THE NEW CROW JIM

the Federation of Dominican Merchants and Industrialists to shut down "Project Bodega."¹⁸⁴

Joseph Occhipinti's trial and conviction was questionable. The bodega owners who testified against him might have been engaged in criminal activities but not detected yet. They may have perjured themselves during Occhipinti's trial, and two of the witnesses were allegedly paid \$20,000 by the Federation of Dominican Merchants and Industrialists to perjure their testimony; Joseph Occhipinti had, on his own behalf, an affidavit filed by former *El Diario* newspaper editor Manuel De Dios which stated that numerous members of the Federation of Dominican Merchants and Industrialists supplied fraudulent complaints and provided perjured testimony against Occhipinti out of fear that Dominican drug lords would kill them and their families. Shortly after providing this affidavit to Staten Island, New York Borough President Guy Molinari, Manuel De Dios was murdered by the Cali Cocaine Cartel, not by Dominicans. He was the first journalist in America to be murdered by a drug cartel. He knew his stuff! May he rest in peace!

After serving 8 months of a 37-month prison sentence President Bush pardoned Occhipinti in 1993. Occhipinti is now Executive Director of the National Police Defense Foundation. Joseph Occhipinti traveled to Italy on August 23, 2015 in order to transport 15 year old Claudia Digregorio to the United States to participate in a clinical research study run by the National Institute of Health (NIH) in Bethesda, Maryland from August 31st to September 5th in order to determine the nature of her disease.

Occhipinti antagonist, Jeh Charles Johnson, was sworn in on December 23, 2013 as the fourth Secretary of Homeland Security after fundraising for Obama.

184. <http://www.nytimes.com/1992/08/06/nyregion/fbi-takes-second-look-at-evidence-in-conviction.html>

Prior to joining DHS, Secretary Johnson served as General Counsel for the Department of Defense, where he was part of the senior management team and led the more than 10,000 military and civilian lawyers across the Department. As General Counsel of the Defense Department, Secretary Johnson *oversaw the development of the legal aspects of many of our nation's counter-terrorism policies*, spearheaded reforms to military commissions system at Guantanamo Bay in 2009, and co-authored the 250-page report that paved the way for the repeal of "Don't Ask, Don't Tell" in 2010.

As General Counsel Jeh did his best to tie the hands of the Defense Department by making sure its actions conformed to criminal law. But where is his experience in law enforcement specifically counter-terrorism?

Secretary Johnson's career has included extensive service in *national security, law enforcement*, and as an attorney in private corporate law practice. Secretary Johnson was General Counsel of the Department of the Air Force from 1998 to 2001, ***and he served as an Assistant U.S. Attorney for the Southern District of New York from 1989 to 1991.***¹⁸⁵

This is the key. He only served two years in law enforcement yet his official biography stated that he had extensive experience in it.

In private law practice, Secretary Johnson was a partner with the New York City-based law firm of *Paul, Weiss, Rifkind, Wharton & Garrison LLP*.

185. <http://www.dhs.gov/secretary-jeh-johnson>

THE NEW CROW JIM

In 2004, Secretary Johnson was elected a Fellow in the prestigious American College of Trial Lawyers, and he is a member of the Council on Foreign Relations. Secretary Johnson graduated from Morehouse College in 1979 and received his law degree from Columbia Law School in 1982.

Morehouse College has a prestigious law school but not Harvard or Yale. *Paul, Weiss, Rifkind, Wharton & Garrison LLP* is a very powerful Leftwing law firm. The lawyers there are in a whole other financial world from the clients they represent. We are talking about an elite bunch of attorneys who only come across Blacks as pro bono clients in court. They traditionally live in all affluent White neighborhoods in Manhattan yet in the 1960's they decided the poorer Jews and Whites had to integrate with the Blacks. They are hypocrites to the core.

Here is how these limo liberals got their start: Jewish lawyers who entered practice in New York City a century ago found it difficult to join non-Jewish law firms and impossible to become partners; instead they formed their own all-Jewish ones.

The firm that eventually became Paul, Weiss, Rifkind, Wharton & Garrison was founded before World War I as a general commercial practice for a small group of wealthy Jewish entrepreneurs of German origin, such as the Straus family, who owned Macy's department store. One of these lawyers was Samuel William Weiss. In 1923, his son Louis started his own firm with a Columbia University Law School classmate, John F. Wharton, a Protestant. They intended their firm, Weiss & Wharton, to be one in which Jews and Gentiles could work together as partners, employees, and clients.

They merged with the earlier firm a few years later, and it now became Cohen, Cole, Weiss & Wharton. Wharton was a

specialist in theatrical law who became the sole trustee of the trusts that controlled the rights to Cole Porter's songs after the composer's death.

With the coming of the Roosevelt Administration's New Deal, Cohen, Cole, Weiss & Wharton emerged as a firm stocked with partners identified with liberal politics and the fortunes of the Democratic Party. One of its lawyers, Walter Pollak, represented the "Scottsboro Boys" four young Alabama Black men convicted of raping a White woman and sentenced to death in a cause célèbre of the 1930s. Lloyd K. Garrison, great-grandson of the abolitionist William Lloyd Garrison and former dean of the University Of Wisconsin Law School, joined the firm in 1945 and represented such clients as Black poet Langston Hughes, playwright Arthur Miller, and physicist J. Robert Oppenheimer in cases involving their communistic political views.

Paul, Weiss became the first major New York law firm to take a woman partner, Carolyn Agger, albeit in the firm's Washington office, established in 1946, rather than in New York. In 1949, it hired William I. Coleman, Jr., an African-American graduate first in his class of Harvard University Law School. A Philadelphia native, Coleman came to New York because, he said, no firm in Philadelphia would hire him. Coleman served on the Warren Commission, and was part of one of the biggest cover-ups in American history. Jeh Johnson became the first African-American partner in the firm which judging from its history had affirmative action as its middle name.¹⁸⁶

JEH HELPED CREATE ISIS

Inferring from a speech Jeh Johnson gave at Oxford University in late November 2012 Jeh was part of the Emperor

186. <http://www.fundinguniverse.com/company-histories/paul-weiss-rifkind-wharton-garrison-history/>

Obama's retinue that played down or ignored the threat posed by ISIS.

In late summer 2011, Islamic State of Iraq (ISI) leader Abu Bakr al-Baghdadi dispatched operatives to Syria to set up a new jihadist organization. Among them was Abu Muhammad al-Jawlani, the leader of what would become al-Nusra which officially announced itself in late **January 2012**. By **November 2012**, Jawlani had built al-Nusra into one of the opposition's best fighting forces.

Due to these successes, Baghdadi changed the name of his group from ISI to ISIS Islamic State of Iraq and Syria in **April 2013** and he publicly announced that al-Nusra and ISIS were one and the same. Abu Muhammad Jawlani rebuffed the change and reaffirmed his allegiance to AQC chief Zawahiri, who later failed to nullify Baghdadi's power play.¹⁸⁷ Using this as background listen to what Johnson ***doesn't have to say about ISI*** in **November 2012**:

We increased the number of combat forces in Afghanistan and have reversed much of the Taliban's momentum in the country. Challenges remain, but violence is down across the country. We have a timetable for transitioning our efforts in Afghanistan to the Afghans' own security forces, and we are adhering to it.

And though we have disagreed with our Afghan partners from time to time, as of this date we have negotiated and signed understandings with the Afghan government on detention operations, special operations and an overall strategic partnership, representing major milestones toward the day when

187. <http://www.washingtoninstitute.org/policy-analysis/view/al-qaeda-in-syria-a-closer-look-at-isis-part-i>

the peace and security of that country is fully in the hands of the Afghan people and their government.¹⁸⁸

There had been a 20 hour assault on the American Embassy in Kabul prior to Jeh making this statement.¹⁸⁹ Johnson was bragging about how Obama is going to adhere to the time table in Afghanistan. Obama reversed the complete withdrawal time table because of an increased Taliban insurgency and the fact that the Taliban controls a lot of Afghanistan. Suicide bombings are increasing across Afghanistan not decreasing. Government officials continue to be targeted. Jeh Johnson cannot predict future insurgency when he is busy denying that a current insurgency does not exist. Jeh:

We banned enhanced interrogation techniques, consistent with the calls of many in our country, including our own military, that great nations simply do not treat other human beings that way. These controversial practices have been banned, yet we continue to gather valuable intelligence in a manner consistent with our Army Field Manual, the Detainee Treatment Act, and international law.

So, just as Holder was more interested in protecting the rights of the Black offender than the victim, Johnson is more interested in protecting the rights of the enemy than members of the American Armed Forces.

There is an awful lot at stake if a terrorist is in possession of a chemical, biological or radiological weapon and if its location has to be beaten out of him to save thousands of lives, so be it.

188. <http://www.lawfareblog.com/jeh-johnson-speech-oxford-union>

189. <http://www.gq.com/story/nato-report-state-of-taliban-afghanistan>

THE NEW CROW JIM

We worked with our Congress to enact the Military Commissions Act of 2009, which reformed our system of military commissions to ensure due process and fairness for the accused. Today, our system of military commissions' prosecutions of Khalid Sheik Mohammed and the other alleged organizers of the September 11 attacks is more credible, sustainable and transparent.

Holder wanted to give Khalid Sheik Mohammed, 911 mastermind, the same rights as a criminal defendant, so he insisted KSM be tried in a Federal Court in New York City. *The New Yorker* reported: "In weighing the cases of Mohammed and his co-conspirators, Holder conferred with top Pentagon lawyers, including Jeh Johnson, the Defense Department's general counsel, and William Lynn, the Pentagon's head of detainee affairs. The Pentagon's prosecutors were initially reluctant to relinquish the cases, but in the end supported the decision."¹⁹⁰

Jeh bragged about America's Military Commission when at one time he opposed them in favor of the criminal justice system. Isn't there someone else around to worry about the rights of terrorists other than the Head of Homeland Security. Maybe he should be on the other side of the issue?

And, finally, we have, in a manner consistent with our laws and values, taken the fight directly to the terrorist organization al Qaeda, the result of which is that the core of al Qaeda is today degraded, disorganized and on the run. Osama bin Laden is dead. Many other leaders and terrorist operatives of al Qaeda are dead or captured; those left in AQ's

190. <http://www.newyorker.com/magazine/2010/02/15/the-trial-2>

core struggle to communicate, issue orders, and recruit.

Just AQ. No mention of al-Nusra or ISIS even though it was getting its act together in Syria and Iraq. The Head of Homeland Security is supposed to be ahead of the game in this area. It sounds like he was one of Obama's advisors who agreed with the President when he called ISIS a Junior Varsity terrorist group.

But, there is still danger and there is still much to do. Al Qaeda's core has been degraded, leaving al Qaeda more decentralized, and most terrorist activity now conducted by local franchises, such as Al Qaeda in the Arabian Peninsula (based in Yemen) and Al Qaeda in the Islamic Maghreb (operating in north and west Africa). So, therefore, in places like Yemen, and in partnership with that government, we are taking the fight directly to AQAP, and continually disrupting its plans to conduct terrorist attacks against U.S. and Yemeni interests.

No mention of problems in Syria and Iraq. Under Obama Yemen has fallen and the American Embassy abandoned. Obama policies have turned Yemen into a failed state. Jeh is just an apologist for Obama.

We have publicly stated that our enemy consists of those persons, who are part of the Taliban, al-Qaeda or associated forces, a declaration that has been embraced by two U.S. Presidents, accepted by our courts, and affirmed by our Congress. We have publicly defined an "associated force" as having two characteristics: (1)an organized, armed group that has entered the fight alongside al Qaeda, and (2) is a co-belligerent

THE NEW CROW JIM

with al Qaeda in hostilities against the United States or its coalition partners.

Okay Johnson is getting warmer with *associated forces* but still no mention of the Islamic State. He is fixated on al Qaeda. Jeh:

Our enemy does not include anyone solely in the category of activist, journalist, or propagandist.

Jeh is a really a blithering idiot. Most of the “American” Mohammedans who join or attempt to join ISIS have been influenced by propagandists who work the internet. The reason the word American appears in quotation marks is because their loyalty is not to the United States but to the Umma, the world Muslim state.

Michael Steinbach FBI Assistant Director, Counterterrorism Division February 11, 2015 had this to say about ISIS propagandists:

We are concerned about the possibility of homegrown extremists becoming radicalized by ***information available on the Internet***. ISIL utilizes high-quality, traditional media platforms, as well as widespread social media campaigns, to propagate its extremist ideas. The group’s ability to produce visually appealing messaging coupled with the rampant use of social media by ISIL supporters exhibits the diverse propaganda capabilities. Combined, these tactics result in sophisticated propaganda which may continue to inspire individuals in the homeland to travel to fight overseas. Recent propaganda releases include multiple issues of English language publications,

including a complete English magazine. Several videos of ISIL-held hostages and videos sensationalizing ISIL members have also been released.

Terrorists also recruit from the ranks of activists, radical Islamist journalists and propagandists like CAIR and Al-Jeezera. Jeh continued:

Nor does our enemy in this armed conflict include a “lone wolf” who, inspired by al Qaeda’s ideology, self-radicalizes in the basement of his own home, without ever actually becoming part of al Qaeda. Such persons are dangerous, but are a matter for civilian law enforcement, not the military, because they are not part of the enemy force.¹⁹¹

Johnson is going to tie the military’s hands when it comes to collecting intelligence on suspected terrorists who are American citizens and operate within the borders of the United States without a direct connection to international terrorists. Military Intelligence should be allowed to track down these future enemy combatants. Jeh is splitting hairs in favor of the terrorists.

All you have to do is watch a few videos, abide by Sharia law and swear bayat to ISIS and you are just as much a part of ISIS as if you were in Iraq. Jeh is more interested in protecting the rights of domestic terrorists than their victims.

I do believe that on the present course, there will come a tipping point – a tipping point at which so many of the leaders and operatives of al Qaeda and its affiliates have been killed or captured, and the

191. <https://www.fbi.gov/news/testimony/the-urgent-threat-of-foreign-fighters-and-homegrown-terror>

group is no longer able to attempt or launch a strategic attack against the United States, such that al Qaeda as we know it, the organization that our Congress authorized the military to pursue in 2001, has been effectively destroyed.

At that point, we must be able to say to ourselves that our efforts should no longer be considered an “armed conflict” against al Qaeda and its associated forces; rather, a counter-terrorism effort against individuals who are the scattered remnants of al Qaeda, or are parts of groups unaffiliated with al Qaeda, for which the law enforcement and intelligence resources of our government are principally responsible, in cooperation with the international community – with our military assets available in reserve to address continuing and imminent terrorist threats.

At that point we will also need to face the question of what to do with any members of al Qaeda who still remain in U.S. military detention without a criminal conviction and sentence. *In general, the military’s authority to detain ends with the “cessation of active hostilities.”*

For this particular conflict, all I can say today is that we should look to conventional legal principles to supply the answer, and that both our Nations faced similar challenging questions after the cessation of hostilities in World War II, and our governments delayed the release of some Nazi German prisoners of war.¹⁹²

192. <http://www.lawfareblog.com/jeh-johnson-speech-oxford-union>

Is this man completely nuts? He is busy predicting a tipping point where Islam, practiced in its true fundamentalist form is going to be wiped out? Just the opposite is happening with recent attacks in France, Tunisia, and Afghanistan. Who is going to alter the Koran that says to fight until every disbeliever in Islam either reverts or is wiped out? The Jews Rifkin and Weiss? This man is in dreamland, not the homeland.

Then after the war ends he wants to release the imprisoned enemy soldiers immediately because America waited too long when it came to releasing the Nazi prisoners. No wonder Obama consulted with Johnson about using his executive powers to become The Emperor Jones of 5 million people who entered the country illegally. So it should come as no surprise that Johnson stated:

We in the administration and the government should give voice to the plight of Muslims living in this country and the discrimination that they face. And so I personally have committed to speak out about the situation that very often people in the Muslim community in this country face. *The fact that there are 1.6 billion Muslims in the world and the Islamic faith is one about peace and brotherhood.*

Brotherhood? He means the Islamic Brotherhood.

JEH JOHNSON AND WILLIAM KUNSTLER

On October 25, 2005, in Washington, D.C., United States District Court Judge Gladys Kessler issued an opinion in the case of four Saudi nationals on hunger strike at the Guantánamo Bay prison camp. In an emergency hearing the week of October 14, lawyers with the law firm of Paul, Weiss, Rifkind, Wharton & Garrison,

THE NEW CROW JIM

which is working in conjunction with the Center for Constitutional Rights (CCR) argued for contact with their clients and immediate access to their medical records.¹⁹³ The CCR was founded by William Kunstler, Jew-hating, Israel-hating and America-hating attorney.

The Center for Constitutional Rights Global Justice Initiative has solicited millions of dollars as well as hundreds of pro bono lawyers from top-tier law firms to support the Center's campaign to defend detainees at Guantanamo Bay.

Between 2001 and 2012, Center for Constitutional Rights coordinated over 500 pro bono lawyers, many from elite “White shoe” law firms, to file suit on behalf of terrorist detainees. Beginning in 2009, Global Justice Initiative gained a direct link to the White House through Attorney General Eric Holder, whose former law firm, Covington and Burlington, had been prominent among those participating in the initiative to defend sixteen Guantanamo detainees.

Johnson is not above playing politics by exploiting the threat of terrorism. When Congress threatened to cut off funding to the DHS and Al-Shabab issued a threatening video Johnson stated:

*If anyone is planning to go to the Mall of America today, they've got to be particularly careful. There will be enhanced security there, but public vigilance, public awareness and public caution in situations like this is particularly important and it's the environment we're in, frankly.*¹⁹⁴

193. <https://ccrjustice.org/home/press-center/press-releases/attorneys-gitmo-detainees-hunger-strike-win-court-order-receive>

194. <http://www.washingtonpost.com/blogs/post-politics/wp/2015/02/22/its-imperative-congress-fund-dhs-jeh-johnson-says/>

During the New Reconstruction Period there was no neglect of protecting the rights of terrorists while screwing over veterans. There was a diminution in America's Armed Forces that left us weaker and attribution of a terrorist offense against our armed forces to work place rage. During this period in our history President Obama has shown no respect for the military and forced a member of the Air Force to cancel his wedding so that he could play a round of golf on a green. There have been more cover-ups like that of the Boston Marathon bombers connection to international terrorism. There were more provocations of dangerous foes such as China and Russia, more double-crossing of Israel and more advancement of Islamism. This is life during the New Reconstruction Era.

When a Mohammad inspired chain immigration terrorist, Akayed Ullah, detonated a bomb in a New York City subway passageway Jeh claimed that the Port Authority passageway was part of his daily commute. Johnson said he happened to be walking above ground in a break with his normal routine. Does he really expect us to believe that the former head of Homeland Security would ride the subway?

CHAPTER EIGHTEEN

OBAMA AND ISLAM

COINCIDENCE OR CONSPIRACY?



Nine months after President Trump promised to defeat ISIS "quickly and effectively," U.S.-backed forces captured Raqqa, which had served as the ISIS capital. The rapidity with which ISIS was defeated tells us that Obama was a Muslim mole who kept ISIS alive by ordering that his troops obey strict rules of engagement and hampering their battle in other ways, such as making them fight alongside gay and transgender troops and screwing up the order of battle. The media suggests that Obama actions culminated in ISIS's defeat in order to hide the fact that Barak Obama played down ISIS and then nurtured them. He is a traitor to the United States and should be tried for treason.

On February 3, 2016 President Barack Obama came out of the closet and visited a Mosque known as The Islamic Society of Baltimore. Mohamad Adam El Sheikh, was a former longtime imam

at the mosque. In 2004, after he left the Islamic Society of Baltimore, El Sheikh was quoted by the Washington Post as saying that suicide **bombings might be acceptable in extreme circumstances**. Mosque attendees included Majid Khan, the al-Qaida member from Baltimore County who pleaded guilty to transporting money used in a hotel bombing that killed 11 people in Indonesia. Khan taught computer classes and directed traffic during Friday prayers at the mosque before he was arrested in Pakistan in 2003.

Khan, who has been held at Guantanamo Bay since 2006, has agreed to cooperate with military lawyers as they prosecute his former al-Qaida comrades. El-Sheikh helped found the Northern Virginia-based Dar Al-Hijrah mosque. This mosque was once led by Anwar al Awlaki, an American al Qaeda affiliate who was killed by a U.S. drone strike in 2011, and was attended by Nidal Hassan, the Ft. Hood shooter.

But none of this mattered to Obama whose actions during his presidency, culminating in having his United Nations Ambassador, Samantha Powers, abstain in a vote condemning Israelis reclaiming Judea, the land they were named after. The Obama Administration released \$221 million to the Palestinians hours before the Trump Inauguration. The outgoing administration notified Congress of move just before Trump's swearing-in, despite Republican opposition.

These are excerpts from the speech Obama gave to Muslims, who although not personally involved in terrorism, give to charities under the guise of Zagat then launder the money and funnel it to jihadists. Obama:

As well as two other great leaders in Congress [who are at the Mosque] —and proud Muslim Americans—Congressman **Keith Ellison** from the

THE NEW CROW JIM

great state of Minnesota and Congressman **Andre Carson** from the great state of Indiana.

Keith Ellison is a “former” member of the Nation of Islam, and helped organize the Million Man March. Defeated for his bid to become Democratic National Chairman, he received the support of Bernie Sanders, a Jew in Name Only. In a 2007 speech, Ellison compared the 9/11 terrorist attacks to the Reichstag fire that helped bring Adolf Hitler to power in Nazi Germany. The Reichstag fire was a 1933 arson attack on the German Parliament that was a false flag operation that helped Hitler assume power.

"Remember 9/11. Right? You had never have [sic] all this discrimination against religious minorities but for 9/11," Ellison said. "You had it, but you didn't have it to the degree that we have it now. 9/11 is this juggernaut event in American history, and it allows—it's almost like, you know, the Reichstag fire kind of reminds me of that. Does anybody know what I'm talking about?"

"But who benefited from 9/11?" an audience member asked.

"Well, I mean, you know, you and I both know," Ellison said.

"Yeah, Bush," the audience member replied.

"But the thing is that, you know, after the Reichstag was burned, they blamed the communists for it, and it put the leader of that country in a position where he could basically have authority to do whatever he wanted," Ellison said.

Ellison used the analogy to compare President George W. Bush to Hitler, arguing the former was granted greater presidential power after Sept. 11, 2001 in a manner similar to the latter following the fire.

Ellison said in 1992 that black Americans do not have an obligation to obey the government because it considers them "less than human." Ellison also told protesters that black people do not live in a democracy. He wrote that the U.S. Constitution is evidence of a white racist conspiracy Ellison once wrote a column that called the U.S. Constitution the "best evidence of a white racist conspiracy to subjugate other peoples."

Rep. André Carson has spent his entire political career in the company of, and advocating on behalf of, Muslim Brotherhood-linked organizations. Carson has extensive ties to the Council on American Islamic Relations (CAIR), the Islamic Society of North America (ISNA), the Muslim American Society (MAS), and others revealed in federal law enforcement documents to be tied to the U.S. Muslim Brotherhood, and (in the case of CAIR and ISNA) to the terrorist organization Hamas. He has been both funded by Islamists, as well spoken at fundraisers on their behalf.¹⁹⁵

In a closed-door meeting on January 13, 2015, House Minority Leader Nancy Pelosi announced that "in the coming days" she would name Carson to the House's Permanent Select Committee on Intelligence, making him the first Muslim to serve on that panel. At the time, Carson was already a member of the House Armed Services Committee. In addition, he had previously worked for the Department of Homeland Security's Fusion Center—the clearinghouse in charge of streamlining the data-sharing process between the CIA, FBI, Department of Justice, and military.

A member of the Muslim brotherhood, whose goal is to inflict Sharia law on non-Muslim infidel countries through the electoral process, was put on the House Intelligence Committee. This is like putting a communist on the House UnAmerican

195. <https://www.opensecrets.org/politicians/summary.php?cid=N00029513>

THE NEW CROW JIM

Activities Committee in the 1950's. Back to the Head Muslim mole's mosque speech:

Now, this brings me to the other reason I wanted to come here today. I know that in Muslim communities across our country, this is a time of concern and, frankly, a time of some fear. Like all Americans, you're worried about the threat of terrorism. But on top of that, as Muslim Americans, you also have another concern—and that is your entire community so often is targeted or blamed for the violent acts of the very few.

And since 9/11, but more recently, since the attacks in Paris and San Bernardino, you've seen too often people conflating the horrific acts of terrorism with the beliefs of an entire faith. And of course, recently, we've heard inexcusable political rhetoric against Muslim Americans that has no place in our country.

Jihad is the universal belief of the Muslim faith however not every Muslim is willing to put their life on the line. Instead they support in financially.

The Muslim American community remains relatively small—several million people in this country. And as a result, most Americans don't necessarily know—or at least don't know that they know—a Muslim personally. And as a result, many only hear about Muslims and Islam from the news after an act of terrorism, or in distorted media portrayals in TV or film, all of which gives this hugely distorted impression.

Pew Research projects that by 2030; the Muslim populations in the United States will more than double. In large part this will be

attributable to immigration; to a lesser degree due to the size of Muslim families. This statistic does not factor in conversion or reversion as the Muslims call it, because everyone is born a Muslim but takes a bad turn somewhere along the line.

No surprise, then, that threats and harassment of Muslim Americans have surged. Here at this mosque, twice last year, threats were made against your children. Around the country, women wearing the hijab—just like Sabah—have been targeted. We've seen children bullied. We've seen mosques vandalized.

But you haven't seen a mass killing at Mosque! Six people were killed and eight wounded when gunmen opened fire at a Quebec City mosque during Sunday night prayers, but that was in Canada not the United States.

We're one American family. And when any part of our family starts to feel separate or second-class or targeted, it tears at *the very fabric* of our nation. So let's start with this fact: For more than a thousand years, people have been drawn to Islam's message of peace. And the very word itself, Islam, comes from salam—peace. The standard greeting is as-salamu alaykum—peace be upon you. And like so many faiths, Islam is rooted in a commitment to compassion and mercy and justice and charity. Whoever wants to enter paradise, the Prophet Muhammad taught, "Let him treat people the way he would love to be treated." For Christians like myself, I'm assuming that sounds familiar. And we can't suggest that Islam itself is at the root of the problem.

THE NEW CROW JIM

That betrays our values. It alienates Muslim Americans. It's hurtful to those kids who are trying to go to school and are members of the Boy Scouts, and are thinking about joining our military.

As you shall see if you continue reading this book, the word "fabric" is a liberal dog whistle term for race. The rest of the speech is false news. Islam is rooted in violence and intolerance, just look at its history and read the Qur'an. The Arabic term "Islam" itself is usually translated as "submission"; submission of desires to the will of God. It comes from the term "aslama", which means "to surrender" or "resign oneself." It means you can be at peace because once you submit to this evil dogma you don't have to worry about getting your head chopped off as an infidel pig. Obama:

Groups like al-Qaeda and ISIL, they're not the first extremists in history to misuse God's name. We've seen it before, across faiths.

This is a current theme of Obama's. Modern day Christians are responsible for the crusades which by the way were fought to prevent Europe from being taken over by the Mohammadans.

But right now, there is a organized extremist element that draws selectively from Islamic texts, twists them in an attempt to justify their killing and their terror. They combine it with false claims that America and the West are at war with Islam. And this warped thinking that has found adherents around the world—including, as we saw, tragically, in Boston and Chattanooga and San Bernardino—is real. It's there. And it creates tensions and pressure that disproportionately burden the overwhelming majority of law-abiding Muslim citizens.

The jihadists are Muslim fundamentalists who take the Qur'an literally. The overwhelming majority of Muslims support the Muslim Brotherhood, which will destroy the constitution, if God forbid, they ever come to power in America. Call that law-abiding?

After more than 200 years, our blended heritage, the patchwork quilt which is America, that is not a weakness, that is one of our greatest strengths. It's what makes us a beacon to the world.

What happened to the melting pot? It has been replaced by a patchwork quilt made in China and composed of a mish mash of races religions all at each other's throats instead of assimilating.

Smug sophisticated complacent New Yorkers ridiculed the Tea Party when it was suggested the Obama was Muslim or had an affinity for Islam. However, as Obama presidency festered, more and more circumstantial evidence surfaced such as his visit to the Baltimore Mosque that made one wonder, are Obama's policies and activities coincidence or conspiracy? Is he a Muslim Mole? Or is he a Muslim groupie like his mother? Obama was intent on bringing Islam into every aspect of American life including Thanksgiving. In 2015 Obama had Dr. Jihad Douglas officiate at the annual turkey pardoning ceremony at the White House. Obama referred to him as "Dr. Douglas," side-stepping the man's first name, which refers to spreading Islam through violence. Obama referred to a second turkey farmer, Joe Hedden, by his first and last names. Obama is a Commander-and-Chief who waited nearly a week before flying the American flag at half mast after a filthy Islamist scum killed 5 members of the military in Chattanooga, Tennessee. Obama invited

Ahmed Mohamed, “the clock boy” who repackaged a digital clock, put it in a metal book carrying case and displayed it to his teachers until he found one who called the cops.¹⁹⁶ Obama backed down in its dispute with Silicon Valley over the encryption of data on iPhones and other digital devices, concluding that it is not possible to give American law enforcement and intelligence agencies access to that information. Obama claimed this would create an opening that terrorists could exploit when exactly the opposite is true.

This decision angered the FBI and other law enforcement agencies. Pen registers and trap and trace devices have long been used for federal law enforcement purposes however Obama made it much more difficult for the NSA to use these programs against terrorists. The federal criminal pen register statute was enacted in 1986 and, in 1998, Congress amended FISA to authorize the NSA to use pen registers to collect foreign intelligence information in national security investigations after obtaining an order from the Foreign Intelligence Surveillance Court (FISA Court). Pen registers record telephone numbers, e-mail addresses, and other dialing, routing, addressing, or signaling information that is transmitted by instruments or facilities - such as telephones or computers - that carry wire or electronic communications. Trap and trace devices record similar information that is received by such instruments or facilities. The information that is recorded is commonly referred to as "metadata" and does not include the contents of communications, which pen registers and trap and trace devices are statutorily prohibited from recording. Having to obtain a court order limited the scope of this intelligence gathering because it changes a broad based procedure into a focused one. For example once someone receives a call or places a call to a suspected terrorist that person’s incoming and outgoing calls are saved and those

196. <http://blogs.artvoice.com/techvoice/2015/09/17/reverse-engineering-ahmed-mohameds-clock-and-ourselves/>

calling them or receiving a call from them are subjected to the same procedure branching out in a pyramidal configuration. The FISA Court would be overloaded with requests. The NSA realized this and instituted a warrantless trap and pen register program and stored it in its own databank. The traitor Edward Snowden revealed this secret and Obama signed legislation forcing NSA to obtain individual warrants, just as if it was ELSUR tap. The data will remain with the Phone Company or ISP for only two years. This came into force a few days before the San Bernadine terrorist raid.

Another piece of the Obama / Muslim is how he reacts to terrorist events. On Nov. 5, 2009, Major Hasan shot and killed 12 soldiers and one civilian while wounding or shooting at 30 other soldiers and two police officers. Prosecutors said one of his motivations was to kill as many soldiers as he could to wage jihad on American military personnel. He told a military mental-health panel the shooting was justified because the soldiers he killed were “going against the Islamic Empire.”

Before the attack, he sent messages and emails to Anwar al-Awlaki, a radical American-born cleric described by officials as the leader of external operations for Al Qaeda in the Arabian Peninsula. Immediately following the first Fort Hood attack, Mr. Obama avoided calling the shooting an act of terror and instead have his subordinates refer to it as “workplace violence.” What was his motive in doing this? To prevent Americans from realizing the threats to life that emanate from Islam?



Obama's affinity to Islamism was engendered by his Muslim groupie mom, Stanley Ann Dunham. It also runs in his blood on his father's side. Obama:

She thought all cultures were fascinating. And she was loved I wasn't brought up with the religion thing I mean we would go to church for Easter sometimes. ***We had a Shinto temple across the street from where we were living. When I was in Indonesia that's a Muslim country and we had Mosques*** but she instilled in me these core values that for awhile I thought were corny and then right around 20 you start realizing honesty, kindness, hard work, looking out for other people are actually pretty good values they are homespun they come out of my Kansas roots. They are the things that ultimate become most important and how I built my life.

Obama's mama was into a smorgasbord of religion. When she was living with her son in the US they attended a Shinto Temple. When they were living in Indonesia they attended a mosque which meant they adopted Islam from the religion of the month club. You can't just walk into a Mosque and start praying, especially if you are a woman. Most of the Mosque is reserved for men but some mosques have a small area for women. One has to recite the Shahada. Obama and his mother had to have said the Shahada to obtain admission to the Mosque.

In Islam, the first of the five pillars is the Shahada. Shahada is the Muslim profession of faith, expressing the two simple, fundamental beliefs that make one a Muslim. "There is no god but God and Muhammad is the prophet of Allah." In other words all other religions are false and Muhammad is a beacon of truth. Obama and his baby mamma (Obama was born out of wedlock) only attended church once a year. This accounts for Obama's lack of sympathy for Christians dying at the hands of Islamists. His [Kansas](#) roots? He hates the Republican majority there.



THE NEW CROW JIM

In August 2010 a national survey by the Pew Research Center found that nearly one-in-five Americans (18%) believed Obama is a Muslim.¹⁹⁷ But Obama has no beard, eats pork, and is pro-gay marriage, pro-abortion and does a lot of other things that are major *shirks*, or sins, in Islam - unless they are necessary in the course of making violent jihad. The media ridiculed the Tea Party for thinking he was a Muslim, but it had part of the truth. Obama was a Muslim for a brief period in his life. But there is a hidden agenda at work here: the reason Obama supports the Muslims is not so much because he believes in Islam but because he hates Jews and despite his protestations that he loves Israel, he either consciously or subconsciously wants to see the State of Israel destroyed. It doesn't matter what religion Obama adheres to - what counts are the results of his policies.



197. <http://www.pewforum.org/2010/08/18/growing-number-of-americans-say-obama-is-a-muslim/>

This attitude of tolerance and hidden agenda resulted in his describing ISIS as a “Junior Varsity” terrorist team and allowing the terrorist enclave to take over half of Syria giving Muslims an excuse to flee to Europe and Islamize it.

This is all part of Obama’s plan to destroy Western Civilization that he believes is inherently racist and imperialist. In February 2015 Obama met with members of the Muslim Brotherhood at a secret White House enclave: Participants included Azhar Azeez, President, the Islamic Society of North America, which is the Muslim Brotherhood.¹⁹⁸ Azeez is head of group of attorneys who security-strip America in the name of Civil Liberties whose real agenda is to create an environment conducive to the initiation of terrorist operations.

Farhana Khera, President, Muslim Advocates attended the secret meeting. Muslim Advocates is part and parcel of the Muslim Brotherhood. Hoda Hawa, National Policy Advisor, *Muslim Public Affairs Council* was there. MPAC co-sponsored pro-Palestinian rallies in the fall of 2000, where MPAC speakers chanted “Khaybar, Khaybar, oh Jews, the Army of Muhammed is coming for you!” The rally featured literature and many placards calling for the annihilation of the Jews and Israel.



198. <http://www.discoverthenetworks.org/printgroupProfile.asp?gpid=6178>

A few hours after the 9/11 terrorist attacks, MPAC Co-Founder Salam Al-Marayati told a Los Angeles talk radio audience: "If we're going to look at suspects, we should look at the groups that benefit the most from these kinds of incidents, and I think we should put the state of Israel on the suspect list." In 2003, MPAC opposed the designation of Hamas and Hezbollah as terrorist groups and suggested that the designation was "based on political considerations." MPAC National Director Ahmed Younis spoke at a Muslim Students' Association sponsored event, where he explained that because Adolf Eichmann was himself a Jew, it could accurately be said that Jews had killed themselves in the Holocaust.¹⁹⁹

Opposed to efforts to shut down Islamic charities that fund terrorism -- alleging that such efforts interfere with freedom of religion and the exercise of the Muslim obligation to give to charity -- MPAC states that the U.S. government should instead investigate what it terms Jewish "terrorists" like the Jewish Defense Organization. The Council signed and sponsored a petition to reinstate the assets of Hamas' charitable front, the *Holy Land Foundation for Relief and Development*, after it was designated as a front for terrorist financing.

Islamist Spring: After a Tunisian fruit vendor set himself on fire in December 2010 touching off the Islamist Spring, President Obama said nothing about the collapsing rule of Zine El Abidine Ben Ali, a longtime American ally, until Ben Ali fled the country; then he celebrated. In November 2011, MPAC held a Washington, DC event in honor of Rachid Ghannouchi, the leader of the Ennahda, the Muslim Brotherhood affiliate that had emerged victorious in the political elections in Tunisia and replaced Ben Ali.

Ghannouchi is a longtime Islamist who, during the 1990s, was invited to the United States by Palestinian Islamic Jihad leader

199. <http://www.discoverthenetworks.org/printgroupProfile.asp?grpId=6177>

Sami Al-Arian but was banned from the country. In March 2015 the Bardo Museum in Tunis was targeted by jihadists. Twenty tourists from Japan, Italy, Colombia, Spain, France, Australia, Poland and Britain were killed, and about 50 others wounded.



In June 2015 at least 37 people were killed in an attack by a gunman on a beach and hotel in the Tunisian resort town of Sousse. “A terrorist infiltrated the buildings from the back before opening fire on the residents of the hotel, including foreigners and Tunisians,” said Interior Ministry Spokesman Mohammed Ali Aroui.²⁰⁰ British, German and Belgian nationals were among the dead, the Tunisian health ministry reported. Another 36 people were wounded in the attack, including up to three people who are in critical condition.

Obama had praised and supported the Arab Spring. All the blood that is on this man’s hands is incalculable. This attack was the result of Tunisia having been governed by Islamists. Tunisia's

200. <http://www.usnews.com/news/world/articles/2015/06/26/report-gunmen-kill-19-in-attack-on-tunisian-coastal-resort>

THE NEW CROW JIM

Ennahda government promoted Sharia. They allowed Islamists to commandeer mosques throughout Tunisia and invited jihadist preachers from the Middle East to preach, while doing little to try and arrest Abou Iyadh, the head of the terrorist group Ansar el-Sharia. More than forty Sufi shrines were torched. Some of the Islamists who morphed into the Ennahda party seemed to consider such targets as legitimate. Three thousand Tunisians traveled to Libya or to the Islamic State for training.

Is it any wonder that the Israeli Government doesn't trust Obama with its national security? Many Israeli believe Obama was waiting for an opportunity to attack Prime Minister Netanyahu and found it when Bibi said he would never allow another terrorist state like Gaza to be formed under his watch and the NGO's were bussing Arabs to the polls in droves. Netanyahu also wanted input in the Iran Nuclear talks and told the U.S. Congress so. Black racists notoriously hate Jews and Obama is their leader.



On **August 13, 2010** evidence that Obama had no regard for the victims of 911, Obama praised an Islamist Provocation at a White House Iftar Ramadan celebration:

Let me be clear: As a citizen and as President I believe that Muslims have the same right to practice their religion as everyone else in this country. That includes the right to build a place of worship and a community centre on private property in Lower Manhattan, in accordance with local laws and ordinances. This is America, and our commitment to religious freedom must be unshakable. The principle that people of all faiths are welcome in this country and that they will not be treated differently by their government is essential to who we are.

What if the Polish Nazis purchased private property adjacent to the Auschwitz death camp and opened a community center there?

Would that be okay with Obama? There are very few Muslims in lower Manhattan who would attend services at the World Trade Center Mosque as there are few Muslims in the neighborhood. The idea of the World Trade Center Mosque was a provocation. It was rubbing New Yorker's noses in shit. Obama continued:

The writ of the Founders must endure. And Ramadan is a reminder that Islam has always been a part of America. The first Muslim ambassador to the United States, from Tunisia, was hosted by President Jefferson, who arranged a sunset dinner for his guest because it was Ramadan making it the first known Iftar at the White House, more than 200 years ago.²⁰¹

201. <https://www.Whitehouse.gov/the-press-office/2010/08/13/remarks-president-iftar-dinner>

THE NEW CROW JIM



The first Muslim Ambassador came to collect a ransom and in doing so turned James Madison into a pimp. The backdrop to this state visit of Sidi Soliman Mellimelli was the ongoing conflict between the United States and the Barbary states, autonomous provinces of the Ottoman Empire that rimmed the Mediterranean coast of North Africa. Soon after the Revolutionary War and the consequent loss of the British navy's protection, American merchant vessels had become prey for Barbary corsairs. Jefferson was outraged by the demands of ransom for civilians captured from American vessels and the Barbary States' expectation of annual tribute to be paid as insurance against future seizures. He took a hawkish position against the prevailing thought that it was cheaper to pay tribute than maintain a navy to protect shipping from piracy.

The crisis with the Mohammedans of Tunis erupted when the USS Constitution captured Tunisian vessels attempting to run the American blockade of Tripoli. The Bey of Tunis threatened war and sent Mellimelli to the United States to negotiate full restitution for the captured vessels and to barter for tribute.

Jefferson balked at paying tribute but accepted the expectation that the host government would cover all expenses for such an emissary. He arranged for Mellimelli and his 11 attendants to be housed at a Washington hotel, and rationalized that the sale of the four horses and other fine gifts sent by the Bey of Tunis would cover costs. Mellimelli's request for "concubines" as a part of his accommodations was left to Secretary of State James Madison. Jefferson assured one senator that obtaining peace with the Barbary powers was important enough to "pass unnoticed the irregular conduct of their ministers."²⁰² The first visit of a Muslim Ambassador was to negotiate ransom from America, not unlike the Islamists of today who take hostages and demand millions of dollars for their release. James Madison was turned into a pimp. This is the real Arab – American history not Obama's distorted version.



In December 2015 Obama made a farce out of the White House Menorah lighting ceremony by having "Rabbi" Susan Talve light the Menorah. Talve is a "reformed" Rabbi, in other words a closeted Christian. This female "Rabbi" is a member of the anti-

202. <https://www.monticello.org/site/research-and-collections/tunisian-envoy>

THE NEW CROW JIM

Israel group T'ruah which is currently promoting assorted "soft BDS" programs designed to destroy Israel's economy and the scum are more interested in the rights of Muslims than in the rights of Jews. The following is from their "Stand Together with American Muslims against Islamophobia" page.

Across the United States today, we see attempts to prevent the construction of mosques, laws **outlawing Sharia law**, and the vilification of our Muslim neighbors and friends as un-American. Jewish historical experience remembers that not too long ago, we too were the victims of suspicion and hatred based on our religion and ethnicity. The actions of the few should not condemn the many, **and every religion has its teachings both of violence and of peace**. Jewish tradition demands that we remember the heart of the stranger, because we were strangers in the land of Egypt. If one minority can be singled out for congressional hearings or restrictions on places of worship, anyone can be.

T'ruah wants to allow Shari'a law districts in America, Christianity and Judaism are equally as violent as Islam which should not be investigated nor any restrictions be put on its places of worship, often recruiting centers for jihadi. What kind of Jews are these self-hating fools. Don't they know it killing Jews is part of Islam? Talve began her speech:

I stand here today with my 90-year-old father whose parents fled the Ottoman Empire. As they passed by Lady Liberty they planted within us the promise that the gates would stay open for all immigrants and refugees who would come to build our nation.

Talve's father was fled the Ottoman Empire wherein a form of Shari's law was in force and came to the United States. Now Talve wants to admit Muslims, who persecuted her father, into the United State? She is making a fool out of him. Immigration is a hot issue. Obama wants to admit 10,000 Syrian refugees into the United States despite the impossibility of adequately vetting them because the records of their existences in Syria had been destroyed. Vetting failed to uncover Tashfeen Malik's jihadist tendencies even though records on her existed in Pakistan and Saudi Arabia. What was the consequence? Syed Rizwan Farook and Tashfeen Malik, a married couple, opened fire at a holiday party at the Inland Regional Center in San Bernardino on Dec. 2, 2015. Fourteen people were killed and 22 injured, most of them county employees. It took Obama days to admit this was a terrorist event, not workplace violence although he ended up saying it might be a combination of the two.

We don't know at this point the extent of their plans. We do not know their motivations. It is possible that this was terrorist-related, but we don't know. It's also possible that this was workplace-related. There may be mixed motives involved in this, which makes the investigation more complicated.

The minute the names of the suspects were really most Americans knew it had to be terror related. Obama still claims the FBI is still searching for a motive when the motive is clear. Both Farook and Malik are Hafez. They know the Qu'ran by heart from cover to cover. There is nothing in their minds but this book. Quran words: 77439 words. Quran verses: 6236 verses Quran chapters: 114.

I stand here today with my fierce family of clergy and black-lives-matter activists who took to the streets of Ferguson to stand firm until all members of the community would see God in the face of the

THE NEW CROW JIM

other. I stand here for two groups of Saint Louis moms, one working to get the guns off of our streets.

The Justice Department determined that the riots, arson and looting in Ferguson, Missouri, was based on lies concocted to frame a police officer but Talve sees the hand of God in this. She stands with moms working to get guns off the streets as if the guns were at fault and not a Black Criminal Subculture churned out by single moms.

I stand here to light these lights that say no to the darkness of islamophobia, and homophobia and transphobia and racism and anti-Semitism and all the other isms that dare to dim our hope.

Jews are in the same class as those pathological individuals who wish to mutilate themselves but can never really change their gender. Jews are freaks just like transsexuals. The Muslims are not going to be overjoyed about being lumped in with gays and trannies.

And I stand here like the Maccabees of old who defied the culture of their time that said that destiny could not be changed and instead, jumped in to write a new story that demanded freedom and equal opportunity for all.

Talve stands with the Maccabees? If she was alive back then she would have been an advocate of sword control.

Let us celebrate the real miracle-- that no matter how much violence there is in Paris, in California or the streets of our nations-- we will respond with more love and more understanding and more

compassion and we will see that the good in us has grown like the lights of Hanukkah-- and in spite of all odds- like the Maccabees of old -- We, too, will win.

Israel's president "Mohammad" Rivlin, who was standing behind her, could be seen mouthing the word "insh'Allah," or "Allah willing." Rivlin, an Arabic speaker, holds a largely ceremonial role in Israel which he has used to promote Arab-Jewish coexistence in Israel. Talve apparently heard him say the Arabic phrase to Obama, and she responded with her own, "Insh'allah, insh'allah, insh'allah."

During a Prayer Breakfast in February 2015 Obama omitted an important part of religious history that Christianity played a large part in the lives of Freeman and instead went way back in history to disrespect it:

So how do we, as people of faith, reconcile these realities -- the profound good, the strength, the tenacity, the compassion and love that can flow from all of our faiths, operating alongside those *who seek to hijack religions for their own murderous ends?* Humanity has been grappling with these questions throughout human history. *And lest we get on our high horse and think this is unique to some other place, remember that during the Crusades and the inquisition, people committed terrible deeds in the name of Christ.*²⁰³

For abolitionist Christian Northerners, victory was God's mandate to change the South. Missionaries founded schools for former slaves and attempted to convert Southern Christians to their anti-slavery views. For former slaves, the church defended new

203. <https://www.Whitehouse.gov/the-press-office/2015/02/05/remarks-president-national-prayer-breakfast>

THE NEW CROW JIM

hopes for freedom. They viewed Emancipation as God's deliverance from bondage. Black churches became not only centers of political action, but also of economic development and education.

Not only did Obama state that ISIS had hijacked Islam, rather than that ISIS is going by the book when it comes to Islam and the book is the Quran, but he compared Christianity to ISIS with his Crusades allusion: The Crusades were military campaigns sanctioned by the Roman Catholic Church during the High Middle Ages and Late Middle Ages 1095 – 1291. The Spanish Inquisition was in 1478. The JDO has heard this comparison before from apologists for Islamic atrocities and it tells us that Obama is no different from them. It's comparing apples and oranges. One thing is a past history of a religion; the other is contemporary and growing! Obama continued:

In our home country, slavery and Jim Crow all too often was justified in the name of Christ.

The first slave ship docked in Jamestown, Virginia in August 1619, and a year before the pilgrims landed at Plymouth Rock. Slavery officially ended December 6, 1865, the day the 13th Amendment to the Constitution was ratified. The Christian clergy played a pivotal role in the abolitionist and Civil Rights Movements. Remember the *Reverend* Martin Luther King? Why blame slavery on Christianity?

So this is not unique to one group or one religion. There is a tendency in us, a sinful tendency that can pervert and distort our faith. In today's world, when hate groups have their own Twitter accounts and bigotry can fester in hidden places in cyberspace, it can be even harder to counteract such intolerance. But God compels us to try.

There have been crimes linked to Christianity such as the shooting of abortionists but these are few and far between. The standard line is that ISIS is to Islam as the Westboro Christian Church is to Christianity.



However the Westboro Baptists don't number more than a dozen wherein the terrorist Islamists are innumerable. JDO knows how to deal with both these Westboro scum: When the Westboro Jew haters came to Brooklyn the JDO trashed their car and slashed its tires. Obama:

And in this mission, I believe there are a few principles that can guide us, particularly those of us who profess to believe. And, first, **we** should start with some basic humility. *I believe that the starting point of faith is some doubt -- not being so full of yourself and so confident that you are right and that God speaks only to us, and doesn't speak to others, that God only cares about us and doesn't care about others, that somehow we alone are in possession of the truth.*

God speaks only to us, and doesn't speak to others is a tenet of Islam more so than diverse Christianity. Islam holds it is in

possession of the only truth. Muslims believe the Old and New Testaments have been altered to cut out any reference to Mohammed who was associating with Moses, Jesus and other Biblical figures. That means all other religions are deliberate frauds and have zero validity. This admonition is aimed at Christians because Obama says “we” should start with basic humility. It should be aimed at Islam. The Jewish religion, however, holds that even if you are not a Jew you can still go to heaven if you follow the Laws of Noah.

At a speech at the 21 Club former NYC Mayor Rudy Giuliani echoed the sentiments of those who resented Obama comparing Christianity to the Islam of ISIS:

I do not believe, and I know this is a horrible thing to say, ***but I do not believe that the president loves America.*** He doesn't love you. And he doesn't love me. He wasn't brought up the way you were brought up and I was brought up through love of this country.²⁰⁴

What is Rudy Giuliani is saying here? Obama is an American hater. He hates people like those attending the speech at the 21 Club. Whites and Jews. He was brought up to be a Communist by his Muslim-loving wife. Or is he making a reference to Frank Marshall Davis, a Black communist who the far Right believes was Obama's mentor?

Or is he saying that despite the fact Obama was brought up by Whites Obama reverted to Black America-hating, cop-hating ghetto culture and has no love of this country?

You criticize Christianity for the part of Christianity that is wrong. I'm not sure how wrong the Crusades

204. <http://www.washingtonpost.com/blogs/the-fix/wp/2015/02/19/how-rudy-giuliani-marginalized-himself/>

are. The Crusades were kind of an equal battle between two groups of barbarians. The Muslims and the crusading barbarians.

What the hell? What's wrong with this man that he can't stand up and say there's a part of Islam that's sick? You've got to be able to criticize Islam for the parts of Islam that are wrong. People find him unemotional except on subjects where he gets emotional. Not the slaughtering of the Christians, not the slaughtering of the Jews, not the slaughtering of the Syrians, but Ferguson.

Why should Obama get emotional about ISIS slaughtering Syrians? He started it by ignoring and belittling ISIS. The Left blames ISIS on Bush and Cheney and the invasion of Iraq but the Islamic State started in Syria due to the Assad Regime. PEW Reseach:

Muslim Legal Permanent Residents, 1992-2012

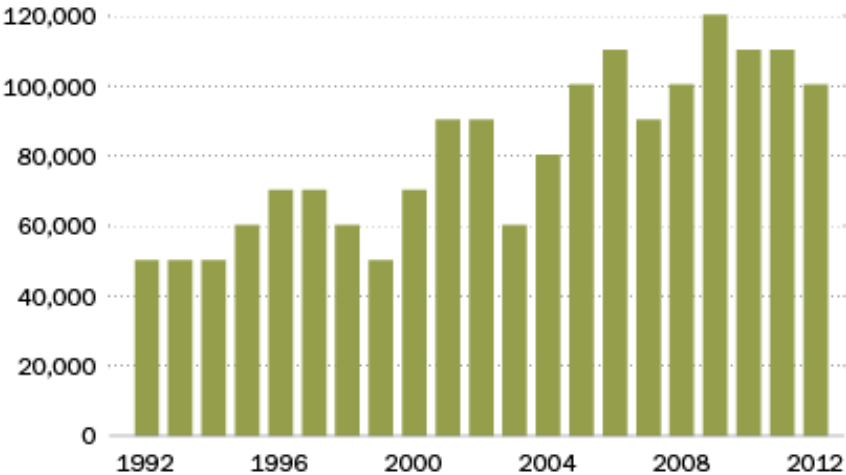

During the New Reconstruction Era more Muslims have to come to America than ever before. During the first year of the Obama presidency Muslim immigration reached its all time high.²⁰⁵ The statistics on the chart above only relate to legal immigrants, not the ones who overstay their visas or sneak in through Canada or Mexico. Once Muslims arrive Muslims marry Christian women who convert to Islam and raise their offspring as Muslim. Additionally they do dawa work to create converts - who they call reverts as Islam states that everyone is born a Muslim but some take a wrong turn along the road of life.

More than three-quarters (77%) of Muslim Americans say they have always been a Muslim, while 23% say they converted to Islam; 9-in-10 (91%) converts to Islam were born in the United States, and almost three-fifths (59%) of converts to Islam are African American.²⁰⁶

Christian Fundamentalists like Mike Huckabee sense Obama's affinity for Islam and hatred of Israel and Jews:

This president's foreign policy is the most feckless in American history. It is so naive that he would trust the Iranians. By doing so, he will take the Israelis and march them to the door of the oven. This is the most idiotic thing, this Iran deal. It should be rejected by both Democrats and Republicans in Congress and by the American people. I read the whole deal. We gave away the whole store. It's got to be stopped.²⁰⁷

205. <http://www.pewforum.org/2013/05/17/the-religious-affiliation-of-us-immigrants/>

206. <http://www.pewresearch.org/daily-number/converts-to-islam/>

207. <http://www.breitbart.com/big-government/2015/07/25/huckabee-obama-marching-israelis-to-door-of-oven/>

Does Obama have the destruction of the Jewish people as part of his hidden agenda by allowing Iran to build a bomb ten years from now? Crypto-Nazis like Ron Paul and Black Nazis alike Al Sharpton back the Iran deal. One thing is for sure, as a result of Obama's hidden Jew-hating agenda, terrorist Islam, which devolves from the mainstream Islam Obama constantly praises as a religion of peace, has made more progress getting parts of the world to regress intellectually than it has under any previous president.

This is why Obama is popular with Muslims and received majority job approval during the first half of 2014 from U.S. Muslims (72%), higher than any other U.S. religious group.²⁰⁸

Former Israeli Ambassador Michael Oren has formulated the "Muslim Bridge" theory of Obama's affinity for Islam: "I could imagine how a child raised by a Christian mother might see himself as a natural bridge between her two Muslim husbands." As this researcher understands it Barak Obama Sr. was an ex-Muslim who eventually married a Jew.

There is a simpler explanation. How bad could Muslims be if me very own mother is schupting one? Or two of them? Not at the same time of course. Stanley Ann Dunham was a real peace of work. Her father wanted a boy so he named her Stanley. She wasn't attracted to or was repulsed by White men. Not in Kansas anymore, almost upon arrival in at college, she met her first boyfriend in **Russian** class, a 23-year-old African exchange student named Barack Hussein Obama. Dunham was pregnant became his baby mama at 17 and married after her 18th birthday, apparently without a clue that her husband had left another wife at home in Kenya.

208. <http://www.pewforum.org/2007/07/06/how-muslims-compare-with-other-religious-americans/>

THE NEW CROW JIM

Was Barack Hussein Obama still a Muslim when he met Stanley Ann Dunham and was allowed more than one wife because he was prosperous or was he a low down varmint that took advantage of and knocked up a 17 virgin from the Midwest? However you want to look at it they were soon divorced.

Meanwhile a scenario was playing out that would help determine the course of her career. On Sept. 30, 1965, six Indonesian army generals and one lieutenant were kidnapped and killed in Jakarta, in what the army characterized as an attempted coup planned by the Communist Party against Suharto. Her brand new shiny Muslim husband Lolo, whose US studies were sponsored by the Indonesian government and who was pro-Suharto, was soon summoned home to serve in the military. A year later, in 1967, Ann graduated with a degree in anthropology, gathered up her 6-year-old love child Obama and moved to Indonesia to join her husband. Her first job was teaching English on behalf of USAID in the American Embassy in Jakarta where the CIA station was located.

The first trial of the failed anti-Suharto coup members had been held in February, 1966, to try coup leader Njono. Njono was a member of the PKI's Politburo and headed the Djakarta regional committee. He was also the chairman of the PKI trade union federation, SOBSI (Sentral Organisasi Buruh Seluruh Indonesia--All Indonesian Federation of Labor Unions). Njono admitted that the Politburo had decided to support the "progressive officers" plan to foil the coup planned by the "Council of Generals."

Njono was sentenced to death in February 1966. After March 1966, repression against SOBSI was stepped up. Many union members were killed or imprisoned. Prior to the crack-down, U.S.-trained trade unionists had gathered information about SOBSI members and sympathizers. Once the massacres and killings began, these lists were used to identify SOBSI followers.²⁰⁹

209. <http://www.sukarnoyears.com/books/Indonesian%20Coup.pdf>

The organization was banned. USAID workers monitored the trade union to make sure it didn't return to its old communistic ways. Stanley Ann Dunham worked with the SOBSI Indonesian Federation of Labor Unions after it had been largely co-opted by the CIA and pro-Suharto elements. Dunham spent years working on rural development, microfinance, and women's welfare through CIA linked organizations including the World Bank, the Ford Foundation, and Bank Rakyat Indonesia.

Was Stanley Ann a spook? Or was she unwittingly used by the intelligence community by providing cover since she was a legitimate aid worker? The answer is simple – very unlikely she was with the Agency as she was married to a foreign national. Was Ann Dunham done with ham and did she say the shahada when she was with Lolo, who was a Muslim? Only her Imam knows for sure. Obama told Marc Maron that a lot of his uncertainty as to his identity and his desire to be a heroin dealer:

"...revolved around issues of race and being able to say that I don't have to be one way to be an African-American but also someone who affirms the White side of my family. I don't have to push back from the love and values that my mom instilled in me.

In other words Obama claims he refused to adopt the anti-White racism of African-Americans and not denounce the values of his White family. He didn't have to adopt their morality to be a true Blackman or did he?

She and I never fought. She was as sweet as could be. She had a good sarcastic sense of humor and she kind of put up with my adolescent rebellion. I always call her the last of the great **secular humanists**. She was she thought all religions had something to say.

Secular humanist is another word for atheist or agnostic. If she was secular, devoid of religious belief why did she marry a

Muslim and an ex-Muslim?

For those who are listening who haven't read my book or something my dad was a tragic figure in many ways a brilliant man by all accounts who sorta took a leap from *a tiny village in the backwaters of Kenya* to suddenly the United States getting a degree attending Harvard and he never managed that leap as well as he could have. And part of the process of me writing the book was to figure out what happened to him and how he became what he was. He ended up becoming an alcoholic and abusive to several wives to some degree a neglectful father. In some ways because I didn't grow up with him he was an abstraction to me. That stuff didn't seep into me.

What tragic flaw in Obama's father's character caused him to be unable to cope with Western society? His father was from the backwoods, his grandfather was a cook for the British colonialists and his great grandfather might have been from the rainforest, hunting, gathering, eating bush meat and living in a very primitive state. Obama is saying that his father was too primitive to deal with the upper echelons of Western civilization.

My mother and my grandparents who did raise me fortified me. One thing they always did that I thought was wise they never portrayed a negative picture of him they actually accentuated what was good about him. I didn't internalize a bunch of negative attitudes about who he was and thereby did think that was who I had to be. I had the adolescent rebellion screw up period that has been well chronicled. But it turned out that a lot of his craziness I didn't end up internalizing.

But where does Obama's Jew hatred agenda come from? Not from his father who presumably divorced his Kenyan wife and married a Jewish woman. It comes from the fact Obama the first hip hop president and is immersed in African-American subculture which is now inherently anti-Semitic. A 1993 survey found not only that African-Americans are twice as likely as Whites to hold anti-Semitic views but significantly that it is among the younger and more educated African-Americans that anti-Semitism is most pronounced.²¹⁰ Obama continued:

OBAMA AND ISLAMOPHOBIA

But just as it is the responsibility of Muslims around the world to ***root out misguided ideas that lead to radicalization***, it is the responsibility of all Americans of every faith to reject discrimination. It is our responsibility to reject religious tests on who we admit into this country. ***It's our responsibility to reject proposals that Muslim Americans should somehow be treated differently***. Because when we travel down that road, we lose. ***That kind of divisiveness, that betrayal of our values plays into the hands of groups like ISIL***. Muslim Americans are our friends and our neighbors, ***our co-workers***, our sports heroes -- and, yes, they are our men and women in uniform who are willing to die in defense of our country. We have to remember that.

"Root out misguided ideas that lead to radicalization."

That means root out the Qu'ran.

Read the Qu'ran is you want to know what motivates Muzzies. "The infidels are your sworn enemies Sura 4:101"

210. <http://www.nytimes.com/1992/07/20/opinion/Black-demagogues-and-pseudo-scholars.html>

THE NEW CROW JIM

“Make war on the infidels who dwell around you Sura 9:123” “When you meet the Infidels in the battlefield, strike off their heads Sura 47:4” “Mohamed is Allah’s apostle. Those who follow him are ruthless to the infidels Sura 48:29” “Prophet, make war on the infidels Sura 66: 9” “Never be a helper to the disbelievers Sura 28:86” “Kill The disbelievers wherever we find them (Sura 2:191)” “Sura 9:29 [And] fight against those (Al-La-Zina) who despite having been vouchsafed revelation [aforetime]-do not [truly] believe either in God or the Last Day, and do not consider forbidden that which God and His Apostle have forbidden, and do not follow the religion of truth [which God has enjoined upon them till they [agree to] pay the exemption tax with a willing hand, after having been humbled [in war]. 47:4

Therefore, when you meet The infidels (unbelievers), smite their necks until you overcome them fully, and then tighten their bonds; but thereafter [set them free,] either by an act of grace or against ransom, so that the burden of war may be lifted. No way around it, as long as they belief this nonsense and practice it, they will never blend in with other countries. So, as with any sociopathic disease, it has to be expelled from the body of civilized nations.

It’s our responsibility to reject proposals that Muslim Americans should somehow be treated differently. So Obama doesn’t want any special surveillance of Muslims so they can commit their foul acts with impunity. They deserve the same amount of attention as nuns do in a convent.

That kind of divisiveness, that betrayal of our values plays into the hands of groups like ISIL.

So Americans created ISIL or ISIS. What prompted Obama to change ISIS to ISIL? This muzzie lover is devious. He did it to confuse people make them think ISIS had been defeated and there is another group called ISIL.

“Muslim Americans are our friends and our neighbors, **our co-workers**” Our co-workers? Look what happened to a Muslim’s co-workers in the San Bernadine jihadist raid. Obama went to San Bernadine to consol the families when it was his very policies that caused their deaths. Finally there are few Muslims in the American Armed forces, and they include Fort Hood jihadist Nidal Hassan.

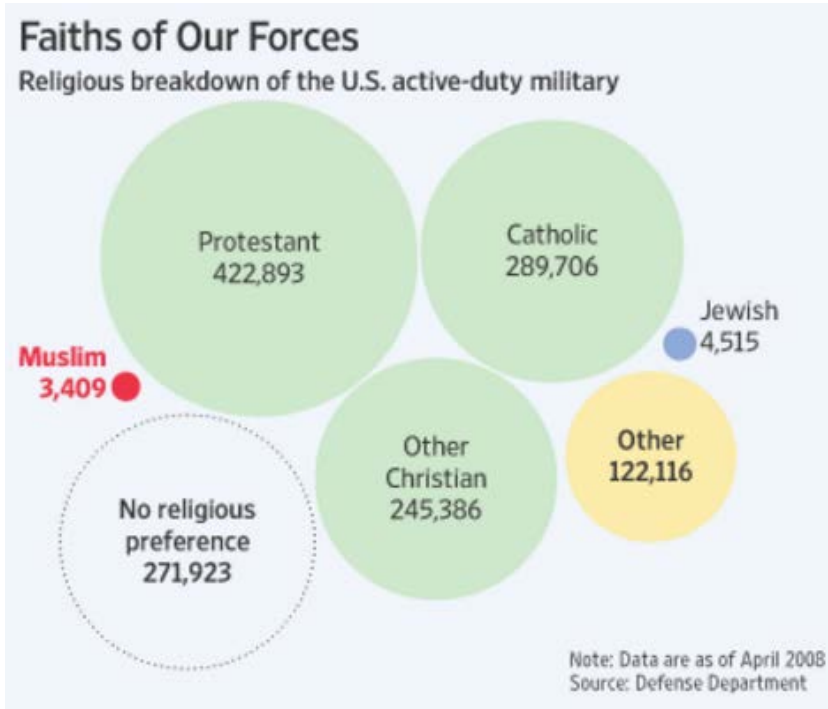

“We are committed to protecting the rights of all Americans — including Muslims — to practice their religion without discrimination whether it be **in the workplace** or at school. This is not blind adherence to political correctness- it is devotion to our founding documents.” Eric Holder - United States Attorney General

THE NEW CROW JIM

In retrospect hollow words. This is a partial transcript of Attorney General Loretta Lynch's remarks at the **Muslim Advocates** dinner on Dec. 3, 2015. When she was introduced it was pointed out that this was her first appearance before a Muslim group.



Question.

What you see as your highest priorities as Attorney General?
Attorney General Loretta Lynch:

...Obviously there are a number of issues that challenge the Department of Justice, many of which the **Muslim Advocates** are deeply involved in. I also thank you for your partnership on so many of those issues as well.

Why speak at Muslim Advocates when they are an enemy of the FBI and of its Countering Violent Extremism Programs. Muslim Advocates sued the FBI for a copy of their Investigate Guidelines

and were actually allowed to look at a copy at an FBI office.²¹¹ That wasn't enough and Muzzie Advocates website states: "Our legal team has been involved in an ongoing effort to seek full disclosure of the unedited copy of the Domestic Investigative Operational Guidelines (DIOGs), the investigative guidelines issued by the FBI to its agents." Look who's ass Lynch is kissing. This is from Muslim Advocates website.

False Assumptions Underlying Countering Violent Extremism Programs

The government's misguided CVE programming is a product of many false assumptions. The "radicalization theory" is perhaps the best known. Although it has been debunked as junk science many times, the FBI and other law enforcement agencies continue to use its rhetoric and rely upon its faulty premises. The theory suggests that there is a "path" down which individuals go that leads to the point of being willing to commit acts of violence. Indicators of so-called radicalization include being part of "Muslim enclaves," wearing "Islamic clothing," growing a beard, abstaining from alcohol and joining advocacy organizations or community groups.

By using identifiably Islamic practices and Muslim community involvement as supposed indications of radicalization, the government stigmatizes Muslims and discourages them from all aspects of practicing their faith, threatening bedrock values of our democracy: freedom of expression, religion, and assembly.

211. http://www.amp-oneb.ghazali.net/html/muslim_advocates_file.html

Anytime law enforcement targets members of a community based upon who they are—instead of behavior indicative of crime—those practices become ineffective and damage the relationships with the communities they are supposed to be serving. In that sense, CVE programs are tantamount to racial and religious profiling.

Further undermining community trust, these programs have been designed to gather intelligence on participating community members and the information used to further target American Muslims without evidence of wrongdoing. Thankfully, President Obama made clear at the Summit his disapproval of using engagement with communities as a cover for surveillance, but it remains to be seen if there will be safeguards put in place to ensure these practices do not continue.

Muslim Advocates argues that Islamist terror only accounts for 4% of the deaths by terrorism in the United States. So why all this focus on the Muslim community? They make a persuasive argument. However, there is one problem with the jihadists without beards and burka's deception. We are not dealing with petty crimes like burglary or heroin dealing. We are dealing with terrorism. The potential crimes here involve dozens; hundreds maybe even thousands of lives. We cannot wait until the Muslims show "behavior indicative of crime" because that might be too late.

There has to be counter-insurgency within the Muslim community and the Mosques that are like cheese for rats. The Muslim Advocates never presents an alternative to CVE other than giving to Muslim charities.

Ironically, government CVE efforts to "build partnerships and build trust" with Muslim

communities often reveal the underlying biases of such efforts. When meeting with Muslim leaders in Southern California in September 2014, for example, Department of Homeland Security Secretary Jeh Johnson actually told them: “This is as much your homeland, your country, your public safety as anybody else’s,” as if they needed to be reminded that they are Americans and should be concerned about public safety.

Another significant problem underlying the government’s CVE programming is an ***overreaction to an exaggerated threat of extremist violence***. Last year, Director of National Intelligence James Clapper told the Senate ***“I have not experienced a time when we have been beset by more crises and threats around the globe.”*** This is basically the same thing he told Congress the previous two years. Such hyperbole does not, of course, accomplish anything except instilling fear.

More insidious, the government has exaggerated the actual threat of extremist violence. In 2007, for example, the Inspector General for the Department of Justice “found that the Department components and the Department as a whole did not accurately report terrorism-related statistics” and overstated terrorism data and overstated the number of terrorism-related convictions.

Lynch is speaking before a group that wants America to become complacent about terrorist attacks so they can become routine and eventually succeed in changing American domestic and foreign policies ***“overreaction to an exaggerated threat of extremist violence.”*** Tell to the victims of the Paris attacks and those in San Bernadine, California.

Lynch:

The work of the department is vary. It's wide. It's multifaceted. I am focusing in the time that I have in four main areas. **But it in no way diminishes the issues that we discover in areas, in others.** And I'm focusing on national security and terrorism.

But as we have seen, the threats are ever evolving and they are widespread. They affect us. They affect our partners.

Lynch is going to make going after anti-Muslim activities a priority on the same level with terrorism.

And I think frankly they are affecting us in really deep and fundamental ways. They're causing us to look at how we evaluate certain crimes and the language that we use to describe them and forcing us and I think in an ultimately very positive way to really grapple with the issue of protecting ourselves and also protecting our rights.

Lynch is saying that we don't use the words "Radical Islam." President Barack Obama said that he refuses to describe the Islamic State and al Qaeda as groups fueled by "radical Islam" because the term grants them a religious legitimacy they don't deserve.

"They are not religious leaders; they are terrorists," Obama said during remarks at a White House event on countering violent extremism. "We are not at war with Islam. We are at war with people who have perverted Islam." They no more represent Islam than any madman who kills in the name of Christianity or Judaism or

Buddhism or Hinduism," he said. "No religion is responsible for terrorism. People are responsible for violence and terrorism." Islam is responsible for terrorism. How do I know, the Quran tells me so. "Strike terror (into the hearts of) the enemies of God and your enemies." Surah 8:60. Lynch:

Question:

Since the tragic attacks in Paris three weeks ago, there's been a decidedly disturbing uptick in anti-Muslim uptick and anti-Muslim rhetoric.

It's been very divisive and many of us frankly feel that the rhetoric is the worst that it's ever been, and we're very concerned about the environment it creates a very toxic environment that might even give license to some to engage in acts of violence. So in light of these attacks and this toxic climate, what message does the federal government have for the American Muslim community?

Attorney General Loretta Lynch:

I think you could not have touched on a more timely issue. Certainly in the wake of Paris, which as a country and as a part of Europe has been grappling with anti-Muslim rhetoric for some time now because of smaller incidents. This large one is really their equivalent of 9/11. And certainly as we saw here in the U.S., ***an incredibly disturbing rise in anti-Muslim rhetoric, the fear that you have just mentioned is in fact my greatest fear as a prosecutor,*** as someone who is sworn to the protection of all of the American people, which is that the rhetoric will be accompanied by acts of violence.

Obviously, the incidents in Paris were a tragedy and I know that everyone sympathizes with the victims there and the tremendous loss of life and we continue to support that investigation. ***But what I think is important to note is that the Department of Justice's view is that we can and will do that. But we also will not give into fear. And my message to not just the Muslim community but the entire American community is we cannot give in to the fear that these backlashes are really based on.*** And I understand. I, we all remember whether it's 9/11 or when a neighbor of yours is assaulted. When you feel that fear, that sense of lack of control and the inability to do something about it...[inaudible] to spin and try and find ways that you think will be the easy fix, the simple way to corral an issue or to contain a concern. And so in many eyes, anti-Muslim rhetoric becomes that path. What's greatly concerning to us is the rise that you've mentioned. And I remember 9/11 and those were very, very difficult days. I heard some disturbing things from people that I never thought I would hear...Now I think the rise of the Internet, the ability of people to issue hateful speech of all types from the anonymity of a screen is something that increases that rhetoric. Now, obviously, this is a country that's based on free speech. But when it edges towards violence. When we see the potential for someone lifting that mantle of anti-Muslim rhetoric or as we saw after 9/11 violence directed at individuals who may not even be Muslims but may be perceived to be Muslims and they will suffer just as well, just as much. When we see that we will take action. My view is that we cannot be ruled by fear.

A. J. WEBERMAN

Because when we're ruled by fear, we're actually not making ourselves safe. We're not effective. We're not thinking things through. We're not looking at what works. We have now sadly a lot of experience in this area and a lot of experience in this field. This is what we do 24/7.

And I know people are saying ***"Oh, if we stop the refugees and sign a bill and make people sign to guarantee them"***, you know this is not the way. I will look at anything and consider anything that will keep the American people safe. But simply rushing to judgment on something as a friend of mine once said we take aggressive action; you don't take impetuous action. Because you then waste your resources and you end up doing more harm than good. So my message to the Muslim community is that we stand with you in this. I think again one of the reasons why I particularly appreciate this invitation is that Muslim Advocates understand the power of language, the powerful harm as we've been talking about.

"Oh, if we stop the refugees and sign a bill and make people sign to guarantee them" this is a proposal I never heard of before.
Lynch:

But the incredible power of language for good, the incredible power of language to educate, to inform, and to illustrate, and you also understand the power of organization and focusing that voice. And I think it is so tremendously important in this time to let your voices be heard. And as you do that know, please know that the Department of Justice and this Attorney General will be your partner in that effort.

THE NEW CROW JIM

Question: We've also been noticing an uptick in hate crime incidents affecting individuals, our institutions, and in the wake of the Paris attacks, we've actually been noticing a disturbing, even greater rate of attacks. What the Justice Department is doing to hold perpetrators of hate crimes accountable?

Attorney General Loretta Lynch:

For us this has been an important issue since 9/11. But I would say in the last several years and as you mentioned most recently we also have seen this uptick and it's incredibly disturbing. I'm incredibly proud of the work that our civil rights division does in terms of cases but also investigations and counseling in areas. But where we do see anti-Muslim rhetoric and actions turn into violence, we do take action. Criminal prosecutions, the Matthew Shepard James Byrd Hate Crimes Act has been incredibly effective for us but I did want to just note that I think we have charged 225 defendants with hate crimes offenses over the last six years, most of those in the last three years. Since 9/11, we've had over 1,000 investigations into acts of anti-Muslim hatred, including rhetoric and bigoted actions, with over 45 prosecutions arising out of that. I think sadly that number's going to continue. I think it's important however that as we again talk about the importance of free speech, we make it clear that actions predicated on violent talk are not American. They are not who we are. They are not what we do. And they will be prosecuted. So I want that message to be clear also.

A. J. WEBERMAN

Question: “When our communities try to build mosques or expand mosques and they essentially encounter opposition at the local level that sometimes is with the veneer of being a zoning issue but under the surface it’s motivated by anti-Muslim kind of attitudes.

And obviously our country has a robust First Amendment guaranteeing freedom of worship and that includes building of houses of mosques. What advice do you have for our community members who are simply trying to go about their First Amendment right to practice their faith and to build a house of worship?

Attorney General Loretta Lynch:

Well, obviously with my own background, I think that’s a very important area. I mean, houses of worship really can be the heart of a community. They can be the cradle of a family. They can be places where our children go to learn not just our faith but to make friends and to build their own connections. And they’re essential to a healthy America and every community deserves the right to have those houses of worship operate in safety and in peace. And as the Muslim community expands, which is a wonderful thing, I mean, Muslims have been in this country as long as any other group. And we have some of the oldest and most beautiful mosques in this hemisphere. We have seen, frankly, a disturbing increase in the rhetoric against them. And I think what you’re going to see are as people continue own this path, which I think frankly is an unfortunate one, but it is one driven by fear, people will try and use things, such as you mentioned the

THE NEW CROW JIM

zoning laws, to try and make them become a bludgeon against a peaceful religion and a house of worship.

I mean, frankly, wouldn't you rather have a house of worship in your midst as opposed to another strip mall, you know, or some other thing. Maybe not. But in terms of the value of it, the value has been seen for years until we get these backlashes.

She is kissing the Muslims asses as they pray. She wants to see more Muslims in America? She wants more Mosques where terrorists are recruited and raids planned? Whose side is she on anyway? Obama put her up to this, she never cow towed to the Muslims before being a church going African-American.

We have a very, very active practice in the RLUIPA litigation. Essentially it protects the freedom to build a mosque and also to practice religion. Most of the cases under that particular statute that get the most attention [from DOJ] tend to be involved institutionalized persons or the rights of prisoners to practice their faith. But also it focuses on the right to build a house of worship in an appropriately zoned area.

And so we have a number of matters in which we have successfully defended the rights of mosques to either expand as is often the case or to build.

And I think probably one of the ones that was the most well known was the Murfreesboro case where I think the law was bent and twisted in a way that showed how strong this backlash can be. And so again, what I would say with that is when you see efforts like that and you have concerns like that, please reach out to the Department of Justice. That

A. J. WEBERMAN

is what we are here for and we are honored to take those cases.

I should also add that in respect to not just houses of worship but other areas in which we are seeing growing areas of concern also and we have for some time now specifically involve our children and the issue of bullying in the schools. And that's an area in which we have partnered with the Department of Education to provide guidance to schools on how to handle situations where students come to them and they feel bullied. And we've seen this for a number of years. We saw it a lot in the New York area unfortunately where there'd be a backlash against the Muslim community in general.

And I think, you know, we as parents often feel we can withstand these issues and we can at least argue back or talk back. But you know, our children go to school and they don't have those tools yet. They don't know, and kids are very good at finding that spot and pushing and so we are very, very active in that front as well. And so what I would urge people to do, if you are aware of situations where children are involved, please contact the Department of Justice and the Department of Education. We can provide guidance, we can have conversations. Everything need not result in a lawsuit.

But some things do have to go to that area. We have, as you know, opened an investigation into the case of the young man in Irving, Texas. You know, we will see where that investigation goes. [Clock Boy]

THE NEW CROW JIM

So you have extreme situations like that. But you also have those everyday things that happen, and we have an important role to play. So please, please think of us there as well.

This is crazy. Muslim Advocates wants to make it more difficult to stop terrorist plots in the name of civil rights violations. This is from the Muslim Advocates website:

October 13, 2015, Philadelphia – Today, the U.S. Court of Appeals for the Third Circuit issued a comprehensive and stirring decision in the case *Hassan v. City of New York*, recognizing that New Jersey Muslims who have been subjected to the New York City Police Department’s program of blanket, suspicionless surveillance stated a valid claim of discrimination on the basis of their religion. The decision reverses a district court ruling dismissing the case.

Muslim Advocates and the Center for Constitutional Rights challenged the spying program on behalf of a diverse group of plaintiffs from throughout the state – ranging from a decorated Iraq war veteran to the former principal of a grade-school for Muslim girls – who share one thing: their Muslim faith. The district court had dismissed the case on February 20, 2014, in a controversial 10-page summary ruling that has been compared to the discredited 1944 Supreme Court case upholding the internment of Japanese-Americans during World War II.

Without subjecting the City’s program to the strict scrutiny required when governments engage in discriminatory practices, the district court simply

accepted the City's claim that the discrimination was justified by its purported goal of protecting national security. The district court also found that any harm to the communities that have been spied on was not caused by the unlawful surveillance program itself, but by the Pulitzer Prize-winning reporting by the Associated Press that exposed it.

The court reaffirmed the elementary principle that law enforcement cannot spy on and harass individuals for no other reason than their religion and the equally important principle that courts cannot simply accept untested claims about national security to justify a gross stereotype about Muslims. There is no Muslim exception to the Constitution," said Center for Constitutional Rights Legal Director Baher Azmy. "This case of religious profiling is the other side of the stop-and-frisk coin, yet the de Blasio administration, which won the election on a platform of police reform, still defends this form of outright discrimination against Muslims.

Referred to as the "Demographics Unit," the unit, advised by an official from the Central Intelligence Agency, had engaged in broad surveillance of Muslim communities, such as neighborhoods, mosques, businesses in New York and New Jersey because that is where the jihadists congregate, not in churches or synagogues. The Unit refused to reveal any of its successes in order not to endanger its methods sources.

MUSLIM ADVOCATES: MOST DANGEROUS MUSLIM SHARIA LAW GROUP IN AMERICA

Muslim Advocates is made up of some pretty [establishment](#) type Muslims primarily of Palestinian origin since Muslim Advocates is basically Hamas and the Muslim Brotherhood.

THE NEW CROW JIM

Its **990 IRS forms** indicate it is run out of Oakland, California by three employees. It raised a third of a million for events and 1.2 million from contributions.

| | (line) | ORG | IND | ST | ST | ST | ST | ST | ST |
|--|--------|-----|-----|----|----|----|----|----|----------|
| (1) FARHANA Y. KHERA PRESIDENT & E.D. | 50.00 | X | | X | | | | | 125,004. |
| (13) NAHEED QURESHI DEPUTY DIRECTOR | 50.00 | | | | | | | X | 110,004. |
| (14) GLENN KATON LEGAL DIRECTOR | 50.00 | | | | | | | X | 100,008. |



Farhana Khera is the first executive director of Muslim Advocates. Prior to joining Muslim Advocates in 2005, Ms. Khera was Counsel to the U.S. Senate Judiciary Committee, Subcommittee on the Constitution, Civil Rights, and Property Rights. In the Senate, she worked for six years directly for Senator Russell D. Feingold (D-WI), the Chairman of the Constitution Subcommittee. Ms. Khera focused substantially on the Patriot Act, racial and religious profiling, and other civil liberties issues raised by the government’s anti-terrorism policies after September 11, 2001. She was the Senator’s lead staff member developing anti-racial profiling legislation and organizing subcommittee hearings on racial profiling.



This is not the headscarf wearing crowd. Many of these Muslims worked at the most prestigious law firms and corporations in America. Some ACLU-types were at very high levels of Government. Glenn Katon: “He also served as Trial Attorney with the U.S. Department of Justice, receiving the Tax Division’s Outstanding Attorney Award in 2001. Mr. Katon began his career as a law clerk to the Honorable Terry R. Means, U.S. District Judge for the Northern District of Texas.”

Naheed Qureshi serves as deputy director at Muslim Advocates. Ms. Qureshi worked for the Washington Legislative Office of the American Civil Liberties Union (ACLU), where she was responsible for the Patriot Act, and other post-September-11th civil rights violations. After 9/11 she was recruited to join the U.S. Department of Justice Civil Rights Division to help shape the Initiative to Combat Post-9/11 Discrimination. She has also gained experience in local government during her time at the City of Los Angeles Department of Neighbourhood Empowerment. Naheed filed for bankruptcy in 2010.²¹²

212. <http://www.freecourtdockets.com/dockets/abdus-salam-queishi-and-naheed-queishi-closed-10-32054-california-northern-bankruptcy-court-docket.html>

THE NEW CROW JIM

Muslim Advocates hires those who represent social and racial classes that have been discriminated against in the past.

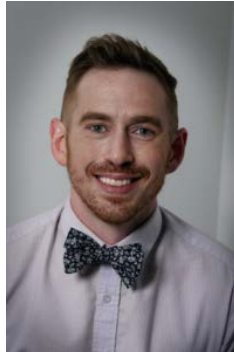

They even hire homosexuals whose fate is sealed under Islam. Scott. Simpson served as an HIV test counselor and youth advocate, as president of the LGBT Congressional Staff Association and as secretary of Q Street, the association of LGBT policy advocates and lobbyists. But there is no record of sharia law groups making threats against it because they know that once Muslim Advocates achieves its goal the gays will go out the window – literally. Muslim Advocates opposes extreme vetting because they want more terrorists to enter the country. This is an excerpt from the Executive Order that was stayed by a “so-called” federal judge with a liberal agenda.

In order to protect Americans, the United States must ensure that those admitted to this country do not bear hostile attitudes toward it and its founding principles. The United States cannot, and should not, admit those who do not support the Constitution, or those who would place violent ideologies over American law. In addition, the United States should not admit those who engage in acts of bigotry or hatred (including "honor" killings, other forms of violence against women, or the

A. J. WEBERMAN

persecution of those who practice religions different from their own) or those who would oppress Americans of any race, gender, or sexual orientation.

(a) To be more transparent with the American people, and to more effectively implement policies and practices that serve the national interest, the Secretary of Homeland Security, in consultation with the Attorney General, shall, consistent with applicable law and national security, collect and make publicly available within 180 days, and every 180 days thereafter:

(i) information regarding the number of foreign nationals in the United States who have been charged with terrorism-related offenses while in the United States; convicted of terrorism-related offenses while in the United States; or removed from the United States based on terrorism-related activity, affiliation, or material support to a terrorism-related organization, or any other national security reasons since the date of this order or the last reporting period, whichever is later;

(ii) information regarding the number of foreign nationals in the United States who have been radicalized after entry into the United States and engaged in terrorism-related acts, or who have provided material support to terrorism-related organizations in countries that pose a threat to the United States, since the date of this order or the last reporting period, whichever is later; and

THE NEW CROW JIM

(iii) Information regarding the number and types of acts of gender-based violence against women, including honor killings, in the United States by foreign nationals, since the date of this order or the last reporting period, whichever is later.

The order was clearly aimed at Jihadist Muslims and would make it much difficult from them to operate as their numbers would be closely monitored. This researcher took a press release from Muslim Advocates and altered it so that the truth about this dangerous group could become apparent.

Muslim Advocates, Southern Poverty Law Center, and Americans United for Separation of Church and State, with the pro bono support of the Arnold & Porter Kaye Scholer law firm, filed a lawsuit to stop the ban for good. The name of our case, UMAA v Trump, speaks volumes because in Arabic “ummah” means “the community.”



FOR IMMEDIATE RELEASE 5 October 2016

Obama and Lynch Justice Department Knuckle Under and Cancel Counter-terrorism Program

The U.S. Department of Justice (DOJ) announced today that it has stopped plans for a controversial countering violent extremism (CVE) initiative due to Muslim Advocates having pressured them into doing so. The cancellation of "Shared Responsibility Committees" (SRCs) today comes after a year of dialogue and protest against the program. SRCs, which would have been directed and controlled by the FBI, would have essentially deputized educators, health care workers, and religious leaders as arms of law enforcement, creating a network of informants which would have made it difficult for the jihadists among us to kill the kefir. Law enforcement has an important job to protect us, but it must not protect the infidels from the death we will inflict upon them.

When Muslim Advocates learned about the SRC program, we began regularly meeting with DOJ officials to discuss the damage likely to be caused by the program to our efforts to create an environment conducive to carrying out terrorist acts. After extensive dialogue with Muslim Advocates, the American-Arab Anti-Discrimination Committee, Arab American Institute, CAIR and other allied organizations, DOJ reexamined SRC plans and ended this dangerous and deeply flawed initiative so there will be plenty of terror attacks coming each one increasing in deadliness.



The SRCs would have convened religious leaders, social workers, health professionals, and local community members to speak with individuals law enforcement identified as "potentially violent extremists" and might have obtained valuable information. While it appeared the participants had to maintain strict confidentiality, couldn't identify themselves as part of the program, or even seek legal counsel, law enforcement could collect and share all information gathered through the program, however they wanted, including with foreign governments. Furthermore, the program appeared to give the committees, which had no legal training, authority to make recommendations for whether individuals should be further investigated by law enforcement. It was highly effective program and had to be stopped in the name of "civil rights" even though we believe in "sharia rights."

As you can see from the chart on the next page Muslim Advocates offers its mureeds a gray area, where it is difficult to ascertain if their money is going to jihadist or charities or both. The bottle line here despite their establishment veneer these Muslim scum are no better than the jihadists they help by creating an environment conducive to terrorism by hamstringing the police and engaging in lawfare. They are an arm of Hamas and had approved KindHearts as a legitimate charity rather than a Hamas front. Muslim Advocates submitted a friend of the court brief when KindHearts assets were frozen because they were a front for Hamas.

THE NEW CROW JIM



Guidance on International Charitable Giving

Muslim Advocates provides this general guidance to donors engaging in international charity. The laws for international philanthropy are complex and constantly evolving. This guidance seeks to clarify permissible and impermissible donations to groups or individuals. We urge donors to exercise due diligence prior to providing money, items or services abroad and to consult with an attorney to provide guidance for your specific circumstances.



RED – Prohibited Items or Activities:

- Money (in any form) or any item (ex. food, blankets, tents, explosives, weapons, personnel, lodging, transportation, communications equipment) to a designated terrorist group*
 - o Exceptions: medicine, religious materials
- Money (in any form) or any item directed to a country on the sanctions list** (ex. Libya, Syria, Iran, etc.)
- For non-US citizens, material support to any terror group listed or not listed by the U.S. government can result in deportation or other adverse immigration action



YELLOW – Consult an Attorney Before Proceeding:

- "Training," "services," or "expert advice" to a designated terror group:
 - o Medical services
 - o Medical equipment
 - o Medical training on treating infectious diseases
 - o Advice on conflict resolution



GREEN – Permissible Activities:

- Medicine
- Religious Materials

Permissible assuming donations are *not* going to a designated terror group.

Some examples:

- Donations to lawful, U.S.-registered 501(c)(3) charities
- Food, drinking water
- Tents, blankets
- Latrines & sanitation equipment
- Medical services, medical equipment
- Clothing

* To determine whether an organization or entity has been designated a terrorist organization by the U.S. government, use the Office of Foreign Assets Control (OFAC) "SDN Search" tool at <http://sdnsearch.ofac.treas.gov/>.

** For more information on the country sanction list, visit <http://www.treasury.gov/resource-center/sanctions/Programs>.

The information contained in this fact sheet is being provided for educational purposes only and not as part of an attorney-client relationship. It is not a substitute for expert legal, tax, or other professional advice tailored to your specific circumstances, and may not be relied upon for the purposes of avoiding any penalties that may be imposed under the Internal Revenue Code or federal or state law.

For more information, contact Muslim Advocates at info@muslimadvocates.org or (415) 692-1484.

The record amply supports OFAC's reasonable belief that blocking pending investigation ("BPI") was warranted to determine if KindHearts was founded to, and did, carry out the role of two previously blocked charitable organizations— the Holy Land Foundation for Relief and Development ("HLF") and the Global Relief Foundation ("GRF"). In December 2001, the Treasury Department designated HLF for its ties to Hamas and blocked pending investigation the assets of GRF for its support to Usama Bin Laden, al-Qaeda and other designated entities. Both actions were upheld against legal challenge. Within a month of the blocking actions against HLF and GRF, Khaled Smaili, a fundraiser for GRF, founded KindHearts and subsequently staffed it with former officials and employees of HLF and GRF, including well-known Hamas leaders with a lengthy track record of providing financial support to Hamas through front organizations purporting to do charitable work. Smaili contracted with, among others, high-ranking HLF officials and fundraisers and GRF's former executive director, some of whom have now been convicted on terrorist-financing related charges. These circumstances alone were sufficient to raise ample suspicion about KindHearts' activities.²¹³ The administrative record for the BPI indicates reasons to believe that KindHearts continued HLF's work with Hamas in Lebanon and the West Bank. KindHearts transferred large amounts of money overseas, especially to Lebanon and the West Bank, ostensibly for

213. Case: 3:08-cv-02400-JGC Doc #: 120 Filed: 07/30/10 6 of 32.
PageID #: 3071

THE NEW CROW JIM

charitable work, and did business with Hamas fronts such as Sanabil Association for Relief and Development, an entity shortly thereafter designated for providing funding, and other support to, and recruiting for, Hamas. Confidential reporting confirmed that KindHearts was relying on Hamas donors, participating in Hamas fundraisers and intentionally funneling money to Hamas. Given OFAC's expertise in terrorist financing in general and HLF's and GRF's personnel, activities and methods in particular, OFAC acted reasonably in issuing the BPI in light of the genesis, history, and activities of KindHearts which were at odds with its claimed concern for its reputation and federal law.

These cases generally discuss reasonable suspicion of a "violation." That terminology is inapposite here because persons are not designated for "violations" of any criminal or civil requirement. As previously explained, designation is not a punishment for specific prohibited acts; rather, it is a decision that the designee falls with those categories of entities whose property should be blocked in order to advance the foreign policy and national security interests of the United States. Violations of the prohibitions in E.O. 13,224 can result in civil or criminal penalties, to which different procedures and standards attach. Accordingly, the applicable standard here would be reasonable suspicion that KindHearts meets one or more of the standards for designation.

One reason for that respect is that national security and foreign policy KindHearts has a sufficient foreign nexus to fall within the broad delegation of authority in IEEPA. Concerns arise in connection

with efforts to confront evolving threats in an area where information can be difficult to obtain and the impact of certain conduct difficult to assess. The dissent slights these real constraints in demanding hard proof-with “detail,” “specific facts,” and “specific evidence” that plaintiffs’ proposed activities will support terrorist attacks. That would be a dangerous requirement. In this context, conclusions must often be based on informed judgment rather than concrete evidence, and that reality affects what we may reasonably insist on from the Government. The material-support statute is, on its face, a preventive measure-it criminalizes not terrorist attacks themselves, but aid that makes the attacks more likely to occur. The Government, when seeking to prevent imminent harms in the context of international affairs and national security, is not required to conclusively link all the pieces in the puzzle before we grant weight to its empirical conclusions.

OFAC has ample reason to believe that KindHearts is a reincarnation of HLF and GRF, two charities previously designated for channeling funds to Hamas and other terrorist groups, in an effort to avoid the applicable sanctions on those charities. The findings of the courts reviewing HLF’s and GRF’s designation challenges are particularly instructive as to these organizations’, and their officials’, substantial ties to Hamas, Al Qaeda, and other terrorist organizations. In August 2002, the district court reviewing OFAC’s December 2001 designation of HLF determined that “the administrative record contains ample evidence that (1) HLF has had financial connections to Hamas

THE NEW CROW JIM

since HLF's creation in 1989; (2) HLF leaders have been actively involved in various meetings with Hamas leaders; (3) HLF funds Hamas-controlled charitable organizations; (4) HLF provides financial support to the orphans and families of Hamas martyrs and prisoners; (5) HLF's Jerusalem office acted on behalf of Hamas; and (6) FBI informants reliably reported that HLF funds Hamas." The court rejected the constitutional and statutory claims of HLF, and the District of Columbia Circuit affirmed in April 2003, finding that "[t]he ample record evidence (particularly taking into account the classified information presented to the court in camera) establishing HLF's role in the funding of Hamas and of its terrorist activities is incontrovertible." In July 2004, HLF and many of its officers, including original Chairman and chief fundraiser El-Mezain, fundraiser and representative Abdulrahman Odeh, and Director Haitham Maghawri, were indicted for a variety of terrorism-related charges, including providing material support to Hamas. On November 24, 2008, HLF and its officers, including el-Mezain and Odeh, but excluding Maghawri, who remains a fugitive, were convicted on Hamas's semi-covert use of charitable foundations to further its goals.

So there you have it. The Chief Law enforcement officer of the United States was talking before a Hamas Front group, under orders from Obama. Loretta Lynch had been effectively recruited into a terrorist support group. Things have taken a bizarre turn. Obama tries to convince the American people that ISIL wants to be wiped out:

We should not be drawn once more into a long and costly ground war in Iraq or Syria. That's what

A. J. WEBERMAN

groups like ISIL want. They know they can't defeat us on the battlefield. ISIL fighters were part of the insurgency that we faced in Iraq. But they also know that if we occupy foreign lands, they can maintain insurgencies for years, killing thousands of our troops, draining our resources, and using our presence to draw new recruits.

So it's a form of neo-military imperialism that has created ISIL not a rebirth of Fundamentalist Islamic thinking, if you want to call it that, and a desire for Islam to rule the world. If we don't occupy foreign lands they will disappear. This bullshit was part of a 15 minute address after the San Bernadine mass murder. One of the jihadists was let in on a fiancé visa but Obama couldn't get it straight:

That's why I've ordered the Departments of State and Homeland Security to review the visa *Waiver program under which the female terrorist in San Bernardino originally came to this country.

It took the Obama Administration months to admit the shootings in Chattanooga, Tennessee were directed by ISIS from overseas. Obama is always downplaying the threat because he is on the side of Islam:

So far, we have no evidence that the killers were directed by a terrorist organization overseas, or that they were part of a broader conspiracy here at home. But it is clear that the two of them had gone down the dark path of radicalization, embracing a perverted interpretation of Islam that calls for war against America and the West.

Everyone knows the Koran does exactly that. Every page is filled with threats against disbelievers and the punishments they will receive in hell for rejecting Islam. It is the duty of every Muslim to force the disbelievers to convert for their own good. Not only does Obama lie about the threat in the homeland he lies about the one abroad.

I don't think they're gaining strength. What is true is that from the start, our goal has been first to contain and we have contained them. They have not gained ground in Iraq, and in Syria they'll come in, they'll leave. But you don't see this systemic march by ISIL across the terrain. What we have not yet been able to do is to completely decapitate their command and control structures. We've made some progress in trying to reduce the flow of foreign fighters, and part of our goal has to be to recruit more effective Sunni partners in Iraq to really go on offense rather than simply engage in defense.

HAMSTRINGING INTELLIGENCE

A Presidential Policy Directive entitled Signals Intelligence Activities²¹⁴ Obama made it more difficult for the NSA to spy on terrorists in the name of "civil liberties."

Our signals intelligence activities must take into account that all persons should be treated with dignity and respect, regardless of their *nationality* or wherever they might reside, and that all persons

214. Policy Directive/PPD-28 <https://obamawhitehouse.archives.gov/the-press-office/2014/01/17/presidential-policy-directive-signals-intelligence-activities>

have legitimate privacy interests in the handling of their personal information.

In light of the evolving technological and geopolitical environment, we must continue to ensure that our signals intelligence policies and practices appropriately take into account our alliances and other partnerships; the leadership role that the United States plays in upholding democratic principles and universal human rights; the increased globalization of trade, investment, and information flows; our commitment to an open, interoperable and secure global Internet; and the legitimate privacy and civil liberties concerns of U.S. citizens ***and citizens of other nations.***

Privacy and civil liberties shall be integral considerations in the planning of U.S. signals intelligence activities. The United States shall not collect signals intelligence for the purpose of suppressing or burdening criticism or dissent, or for *disadvantaging persons based on their ethnicity, race, gender, sexual orientation, or religion.* Signals intelligence shall be collected exclusively where there is a foreign intelligence or counterintelligence purpose to support national and departmental missions and not for any other purposes.

When he left office Obama was in the same league as Pol Pot in the suffering to humanity his “no boots on the ground” policies caused. Nearly 60 million people were driven from their homes by war and persecution, most from Islamism, since Obama took power, an unprecedented global exodus that has burdened fragile countries with waves of refugees and littered deserts and

THE NEW CROW JIM

seas with the bodies of those who died trying to reach safety.²¹⁵ This is the first time that has happened on this scale since World War II. Much of this is a result of Obama's tolerance of evil both at home and abroad. When you have to power to stop evil and don't use that power you become part of that evil. Refugee camps and graveyards are the Obama presidential legacy, not peace and Obamacare. To allow unmitigated evil of ISIS to spread like a cancer throughout humanity while having the power to stop it makes Obama as evil as those who do the deeds. If, in 15 years, Obama's Iran Nuclear deal results in a second Holocaust then history must label him a Black Adolf Hitler.

215. <http://www.nytimes.com/2015/06/18/world/60-million-people-fleeing-chaotic-lands-un-says.html>

CHAPTER NINETEEN

THE CONSEQUENCES OF “NO BOOTS ON THE GROUND”

Obama caused more deaths, injuries and suffering in the world than any other US president. He did this deliberately to further Islam. He is war criminal and should be tried at the Hague. Obama was more interested in praising the Arab Spring than praising Mubarak for keeping the Islamists on the defensive in Egypt. In fact Obama destabilized Egypt with a dog whistle speech.

THE CAIRO UNIVERSITY SPEECH



I have known Islam on three continents before coming to the region where it was first revealed –
Barak Hussein Obama

Obama invited at least ten members of the outlawed Moslem Brotherhood to his speech in Cairo in June 2009. From the Brotherhood website:

MUSLIM BROTHERHOOD IN AUDIENCE FOR OBAMA
CAIRO SPEECH – Feature Cairo - At least 10 members
of parliament from Egypt`s banned Muslim

THE NEW CROW JIM

Brotherhood will attend US President Barack Obama's landmark speech to the Muslim world in Cairo, it was confirmed by the group Tuesday.

As well as various lawmakers, activists, charity workers and non-governmental organizations at the address, invitations have been sent to the group for the keynote speech.²¹⁶

It wasn't what he said during that speech, it was who he invited that really mattered. Obama gave the signal to anti-Mubarak elements that America no longer supported the anti-Islamist Egyptian strongman Hosni Mubarak. Obama said that "America respects the right of all peaceful and law-abiding voices to be heard around the world, ***even if we disagree with them***" a veiled reference to the Muslim Brotherhood.

The Brotherhood is composed of Islamists who wish impose Shar'ia law on Egypt, then the world, through the electoral process rather than through jihad, as they have been beaten at that violent game in the past. Once they have done this in a country they will terminate democratic process and institutions, consolidate power and form a theocracy based on Shar'ia. This is what Obama told the Muslim Brotherhood and the others:

I am convinced that in order to move forward, we must say openly to each other the things we hold in our hearts and that too often are said ***only behind closed doors***.²¹⁷

216. <http://www.ikhwanweb.com/article.php?id=20326>

217. <https://www.Whitehouse.gov/the-press-office/remarks-president-cairo-university-6-04-09>

Obama is addressing Egyptians who live in a repressive country, thanks to the Islamists, to voice their opposition to the Mubarak Government in public rather than behind closed doors. Mubarak has always been a close ally of America and that gives added credence to the fact that Obama is double-crossing him just the way he double-crossed the Israelis.

There must be a sustained effort to listen to each other; to learn from each other; to respect one another; and to seek common ground. As *the Holy Koran* tells us, "***Be conscious of God [Allah] and speak always the truth.***" That is what I will try to do today -- to speak the truth as best I can, humbled by the task before us, and firm in my belief that the interests we share as human beings are far more powerful than the forces that drive us apart.

Obama took this quotation out of context. He was reading from Chapter 9 Verse 119 of the Quran, which deals with the theme of not abandoning Muhammad. The Qu'ranic passage immediately after it continues:

Neither the dwellers of the city, nor the Arabs around them, shall seek to stay behind the messenger of Allah (when he mobilizes for war). Nor shall they give priority to their own affairs over supporting him. This is because they do not suffer any thirst, or any effort, or hunger in the cause of Allah, or take a single step that enrages the disbelievers, or inflict any hardship upon the enemy, without having it written down for them as a credit. Allah never fails to recompense those who work righteousness.

THE NEW CROW JIM

The two passages are part of a Quranic section scolding local Muslims in Medina for refusing to accompany Muhammad on a war expedition to Tabouk in northern Arabia, where he was seeking to fight a Byzantine garrison. Obama continues:

Now part of this conviction is rooted in my own experience. I'm a Christian, *but my father came from a Kenyan family that includes generations of Muslims*. As a boy, I spent several years in Indonesia and ***heard the call of the azaan at the break of dawn and at the fall of dusk***. As a young man, I worked in Chicago communities where many found dignity and peace in their Muslim faith.

Obama is saying the despite the fact that he is a Christian Islam runs in his blood. When Obama was in Indonesia his religion was listed as Islamic on a Catholic school application. He claims it was part of a series of errors on the document. Heard the call of the azaan two times a day? What about the other three times? Obama means call as in to summon to a specific office, profession, etc: he was called to Islam. In the Maron interview Obama intimated Islam was one of several religions his mother introduced him to including Shintoism and Christianity.

What the case maybe Obama had a certain affinity for and familiarity with Islam which continued when he was a community organizer in Chicago where he realized once again there was peace and dignity in Islam. Obama continued to woe the Brotherhood:

Moreover, freedom in America is indivisible from the freedom to practice one's religion. That is why there is a mosque in every state in our union, and over 1,200 mosques within our borders. *That's why the United States government has gone to court to protect the right of women and girls to wear the hijab and to punish those who would deny it.*

Obama approves of Islam spreading in America even though he is on different sides of the abortion, gay marriage, prohibition issues. It is instrumental in changing the fabric of America and that is most important to Obama and other Black racists.



ALICIA KEYES GLAMORIZES BURKA

Obama had Holder threaten to fine or imprison employers who objected to their employees wearing hijab or head scarf because it was bad for business. He had the Justice Department enforcing Sharia law. What about burkas? Should American states be punished for making women take off their burkas so they can be photographed for driver's licenses?

Obama continued:

I'm aware that there's still some who would question or even justify the events of 9/11.

Obama knows that his audience is filled with Muslims who are 911 Revisionists who believe, or pretend to believe, the Jews or George Bush was behind the event. It was a Black Racist, LeRoy Jones, who propagated the lie that no Jews showed up for work in the Twin Towers that day. Now his son is Mayor of Newark. Obama is addressing those slime in the audience who were happy about 3,000 or more Americans dying that day and justified the events based on America support of Israel. What kind of America hating, Israel hating audience is the President of the United States addressing? But it should not be unexpected as Obama has had 911 revisionists in his administration. Remember Obama's African-American Green energy czar appointee Van Jones? Obama continued his Cairo speech:

The Holy Koran teaches that whoever kills an innocent is as -- it is as if he has killed all mankind. And the Holy Koran also says whoever saves a person, it is as if he has saved all mankind. The enduring faith of over a billion people is so much bigger than the narrow hatred of a few. Islam is not part of the problem in combating violent extremism it is an important part of promoting peace.

This quotation is taken totally out of context. The verse:

For this reason, We made it a ***law for the children of Israel*** that the killing of a person for reasons other than legal retaliation ***or for stopping corruption in the land is as great a sin as murdering all of mankind.*** However, to save a life would be as great a virtue as to save all of mankind. Our Messengers had come to them with clear authoritative evidence but many of them (Israelites) thereafter started doing wrong in the land.²¹⁸

218. <http://corpus.quran.com/translation.jsp?chapter=5&verse=32>

This was law for the Children of Israel, the Jews, not for the Mohammedans. Obama's out of context quotation omitted the ambiguous "spread of corruption" clause which could mean anything that corrupts Islam such as Christian proselytizing.

In reality the Quran contains at least 109 verses that call Muslims to war with nonbelievers and murder them for the sake of Islamic rule. Some are graphic, with *commands to chop off heads* and fingers and kill infidels wherever they may be hiding. So ISIS is just going by the book. Muslims who do not become "Koranbots" are called 'hypocrites' and warned that Allah will send them to Hell if they don't join the slaughter. Obama continued:

Today, America has a dual responsibility: to help Iraq forge a better future -- and to leave Iraq to Iraqis. And I have made it clear to the Iraqi people -- (applause) -- I have made it clear to the Iraqi people that *we pursue no bases, and no claim on their territory or resources. Iraq's sovereignty is its own. And that's why I ordered the removal of our combat brigades by next August.*

That is why we will honor our agreement with Iraq's democratically elected government to remove combat troops from Iraqi cities by July, and to remove all of our troops from Iraq by **2012**. We will help Iraq train its security forces and develop its economy. But we will support a secure and united Iraq as a partner, and never as a patron.

There it is in Black and White. This is the signal to the jihadists to lock and load because the opportunity to destroy the rag tag Iraqi army is not far off. When the American troops are away the jihadist rodents will play. Obama continued:

THE NEW CROW JIM

Around the world, the Jewish people were persecuted for centuries, and anti-Semitism in Europe culminated in an unprecedented Holocaust. Tomorrow, I will visit Buchenwald, which was part of a network of camps where Jews were enslaved, tortured, shot and gassed to death by the Third Reich. Six million Jews were killed -- more than the entire Jewish population of Israel today. **Denying that fact is baseless, it is ignorant, and it is hateful.** Threatening Israel with destruction or repeating vile stereotypes about Jews is **deeply wrong**, and only serves to evoke in the minds of Israelis this most painful of memories while preventing the peace that the people of this region deserve.

So we find that not only does Obama have 911 Revisionists in his audience he has Holocaust deniers, those who want to play down the numbers of Jews who were systematically murdered by the Nazis or deny it ever happened so there can be another Holocaust and deny that one happened too. They also want to delegitimize the basis for the State of Israel. Notice how he says “deeply wrong” instead of downright evil.

It is no wonder that during a pro-Muslim Black racist’s watch the Islamist State or ISIS became the most successful terrorist Islamist group in recent history. This was thanks largely to Obama and its Imam and military leader Abu Bakr al-Baghdadi al-Husseini al-Qurashi, a hard core Koranbot who hopes to someday rule the entire planet earth. Baghdadi added the al-Husseni to make it seem as if he was related to Mohammad, who was the first Koranbot. There is no upgrade available for Koranbot software and their programming essentially remains the same today as when it was first installed at sword point by Mohammad Gates.



Baghdadi was born in 1971, and earned a doctorate in Islamic studies from the Islamic University in Baghdad. He worked as a professor of Sharia Law before becoming a Salafist preacher. In the Diyala province of Iraq he founded an armed group named Jaish Ahl-Sunna wal Jamaa.²¹⁹ This jihadist umbrella group murdered American soldiers. The Pentagon says that Baghdadi, after being arrested in Fallujah in early February 2004, was released that December 2004 with a large group of other prisoners deemed low level.²²⁰

While he was in prison Baghdadi was in charge of the Shari'a Law Courts there, a jailhouse Imam. According to US Department of Defense records, al-Baghdadi was held at Camp Bucca as a "civilian internee" by US Forces-Iraq from February until December 2004, when he was recommended for an "unconditional release" by a Combined Review and Release Board. This is why he was cut loose:

219. <http://www.al-monitor.com/pulse/originals/2014/02/iraq-isis-baghdadi-mystery.html>

220. <http://www.nytimes.com/2014/08/11/world/middleeast/us-actions-in-iraq-fueled-rise-of-a-rebel.html>

THE NEW CROW JIM

Baghdad, Iraq, **Aug. 29, 2004** – The newly formed Combined Review and Release Board considered the detention of 300 security detainees during its first week of deliberation ending Aug. 28. The board will consider the release, release with a guarantor or the continued detention of nearly 3,700 eligible security detainees, officials said. The 9-member board brings together six representatives from the interim Iraqi government's ministries of justice, interior and human rights with three senior officers from the multinational force to determine which detainees remain a security threat as a result of anti-Iraqi activities. The CRRB conducted its first meeting Aug. 21 and meets at least three days per week. The board will continue to meet as long as it is deemed necessary for Multi-National Force-I to hold security detainees, as authorized by United Nations Security Council Resolution 1546, officials said.

The new process replaces the previous Multi-National Force-I board *consisting of three senior officers, providing greater oversight by the Iraqi government in the review process* and further ensuring that the circumstances surrounding a detainee's capture are reviewed impartially to determine whether he should continue to be held, officials said.

The final approval for all releases rests with the multinational force's deputy commanding general for detainee operations, *Army Major General Geoffrey Miller*, who will make a decision after consulting with the Iraqi justice minister. Miller vowed to accept the board's recommendations unless substantial

additional information about a detainee becomes available that would cause the file to be sent back to the board for further review.²²¹

Why was Baghdadi released even though he had a history of violence against Americans? Too much authority was turned over to the Iraqi Shiite government by President Bush too soon.²²² Baghdadi immediately joined other Islamists known as the Islamic State of Iraq AKA Al-Nusra and a year after his release his face appeared on a wanted poster issued by the Iraqi Government.

While Abu Bakr was locked up Abu Omar Baghdadi became the leader of the Islamic State of Iraq, an umbrella group of Sunni militant forces that included Al Qaeda in Mesopotamia, the jihadist group led by foreigners. As the titular head of the Islamic State in Iraq, Baghdadi issued incendiary murderous fatwa's. One of Abu Omar al-Baghdadi chief Lieutenants was Abu Bakr al-Baghdadi.

In May 2010 the group named Abu Bakr al-Baghdadi as the new leader. On **October 4, 2011** the Office of Foreign Assets Control released this Specially Designated Nationals List Update:

The following individuals have been added to OFAC's SDN list:

Abu Bakr al-Baghdadi al-Husayni; a.k.a. Al-Qurashi, Abu Bakr al-Baghdadi al-Husseini; a.k.a. DOB 1971; POB Samarra'i, Iraq (individual)

221. <http://www.defense.gov/news/newsarticle.aspx?id=25428>

222. The Left and the conservative former judge Jean Pirro both claim that Baghdadi was released in 2009. The Leftists claim Baghdadi was a not an Islamist before he was picked up by the American neo-con imperialists and became one after he was subjected to inhuman imprisonment. Jean Pirro wanted to blame his release on Obama so she added some extra years to his brief detention, which in reality lasted 10 months.

THE NEW CROW JIM

[Specially Designated Global Terrorist]²²³

Abu Du'a



ALIASES/NAME VARIANTS:
Dr. Ibrahim 'Awwad Ibrahim
'Ali al-Badri al-Samarrai',
Ibrahim 'Awad Ibrahim
al-Badri al-Samarrai,
Abu Dusa', Dr. Ibrahim,
Abu Bakr al-Baghdadi

DATE OF BIRTH: 1971

PLACE OF BIRTH: Samarra', Iraq

HAIR: Black

EYES: Brown

Wanted

Abu Du'a is the senior leader of the terrorist organization, al-Qa'ida in Iraq (AQI). Abu Du'a is in charge of overseeing all AQI operations and is currently based in Iraq. AQI was listed by the UN 1267 Committee in 2004 under permanent reference number QE.J.115.04. Abu Du'a is responsible for managing and directing AQI large-scale operations, such as AQI's 28 August 2011 attack on the Umm al-Qura mosque in Baghdad which killed prominent Sunni lawmaker Khalid al-Fahdawi.

In a statement eulogizing Usama Bin Ladin, Abu Du'a threatened violent retaliation for Bin Ladin's death. Three days after Bin Ladin's death, Abu Du'a claimed responsibility for an attack in Hilla, Iraq, that killed 24 policemen and wounded 72 others. On 15 August 2011, a wave of AQI suicide attacks began in Mosul, Iraq, which culminated in over 70 deaths. Shortly thereafter, Abu Du'a pledged on AQI's website to carry out 100 attacks across Iraq in retaliation for Bin Ladin's death.

Reward

Up to \$10 Million Reward

If you have any information concerning this person, please contact your local FBI office if you are in the United States, or the nearest US Embassy or Consulate.

If you prefer to use e-mail, send your information to rfj@state.gov.

If you prefer to use the telephone, please call **1-800-US REWARDS**.

www.rewardsforjustice.net

On **July 23, 2012** ISIS reigned terror on Iraq. The attacks followed a declaration by Abu Bakr Baghdadi, drawing parallels between its hostility to the Shiite-led government in Iraq and the predominantly Sunni revolt against President Bashar al-Assad of Syria, whose Alawite sect is closely aligned to the Shiites and who controls the Shiite Hezb'allah.

223. <http://www.treasury.gov/resource-center/sanctions/OFAC-Enforcement/Pages/20111004.aspx>

However the Obama Treasury Department deleted about ten times the number of terrorists from the list than it added

Baghdadi, in a 33-minute speech on an Al Qaeda Web site promised that a new offensive, which he called *Breaking Down Walls*, would begin soon. He described the impending campaign as part of a battle by Sunnis against Iraq's Shiite leaders and people.

Breaking Down Walls resulted in coordinated attacks on the prisons at Abu Ghraib and Taji that were carefully synchronized operations in which the terrorist insurgents used mortars to pin down Iraqi forces, employed suicide bombers to punch holes in their defenses and then sent an assault force to free the terrorist prisoners.

During his speech to the National Defense University Fort McNair Washington, D.C. ten months later, on **May 23, 2013**, Obama made an oblique reference to the Islamist terrorists operating in Iraq and Syria:

Unrest in the Arab world has also allowed extremists to gain a foothold in countries like Libya and Syria. But here, too, there are differences from 9/11. In some cases, we continue to confront state-sponsored networks like Hezbollah that engage in acts of terror to achieve political goals. *Other of these groups are **simply** collections of local militias or extremists interested in seizing territory.* And while we are vigilant for signs that these groups may pose a transnational threat, most are focused on operating in the countries and regions where they are based.²²⁴

Obama made an oblique reference to ISIS when he said "*extremists interested in seizing territory*" and said it did not pose a

224. <https://www.Whitehouse.gov/the-press-office/2013/05/23/remarks-president-national-defense-university>

transnational threat but only endangered Syria and Iraq. He is deliberately played down the threat posed by the Islamic State because he created it by not leaving a residual force in Iraq. The two terrorists who attacked *Charlie Hebdo Magazine* in Paris for depicting Mohammad were trained in the Islamic State and well known to French counter-terrorist officials. This was a transnational operation. Obama's analysis that ISIS was a local threat proved false.

Obama does not approve of making fun of the Prophet. In 2012 White House Press Secretary Jay Carney told the press pool.

Well, we are aware that a French magazine published cartoons featuring a figure resembling the Prophet Muhammad, and obviously, we have questions about the judgment of publishing something like this. We know that these images will be deeply offensive to many and have the potential to be inflammatory.²²⁵

In **February 2015** Obama had this to say at the National Prayer breakfast.

But part of humility is also recognizing in modern, complicated, diverse societies, the functioning of these rights, the concern for the protection of these rights calls for each of us to exercise civility and restraint and judgment. And if, in fact, we defend the legal right of a person to insult another's religion, we're equally obligated to use our free speech to condemn such insults and stand

225.

<https://www.washingtonpost.com/blogs/erik-wemple/wp/2015/01/08/on-cnn-jay-carney-sticks-to-position-that-charlie-hebdo-should-have-pulled-back/>

shoulder-to-shoulder with religious communities, particularly religious minorities who are the targets of such attacks. Just because you have the right to say something doesn't mean the rest of us shouldn't question those who would insult others in the name of free speech. Because we know that our nations are stronger when people of all faiths feel that they are welcome, that they, too, are full and equal members of our countries.²²⁶

First off no one SAID anything. What we are dealing with here is freedom of artistic graphic expression. Obama is standing shoulder to shoulder with those who struggle to limit artistic freedom and stop people from drawing Mohammad. All we are talking about is the right to draw or paint, not the right to bomb Mosques.

Secondly, President of the United States becoming involved and condemning those who satirize Islam only serves to encourage and legitimize those terrorists who would take violent actions against those who are perceived as insulting the prophet. Obama believe free speech and artistic freedom ends when Islam is involved.

Unlike other world leaders, Obama failed to show up at the memorial in Paris to those killed in the *Charlie Hebdo* and kosher supermarket attacks despite his having pledged solidarity with the French. He issued this statement:

I strongly condemn the horrific shooting at the offices of *Charlie Hebdo* magazine in Paris that has reportedly killed 12 people. Our thoughts and prayers are with the victims of this terrorist attack

226. <https://www.Whitehouse.gov/the-press-office/2015/02/05/remarks-president-national-prayer-breakfast>

THE NEW CROW JIM

and the people of France at this difficult time. France is America's oldest ally, and has stood shoulder to shoulder with the United States in the fight against terrorists who threaten our shared security and the world.²²⁷

By not showing up at the memorial Obama again gave his tacit approval to the jihadist attacks confirming the fact America had a Jew-hating African-American racist President who does not believe in the Bill of Rights. Soon there was a similar attack at a Draw Mohammad Contest in Garland, Texas by two Black Islamists and one Arabic one. ISIS tweeted:



If there is no check on the freedom of your speech, then let your hearts be open to the freedom of our actions The 2 Brothers attained shahdah in texas! O Kuffar know that death is better than living humiliated! Allahu Akbar!!! The brothers in texas may have had no experience in shooting but they was quick to defend the honor of the Prophet Muhammad s.a.w ! #GarlandShooting

Baruch Ha'shem the terrorists were taken out before they could commit mass murder. What Pamela Geller, organizer of the

227. <https://www.Whitehouse.gov/the-press-office/2015/01/07/statement-president-attack-france>

event, proved was that America is infested with Muslim scums who have no respect for the Constitution? This was just the beginning: After the Muslims have intimidated the artistic community into not drawing Mohammad next comes intimidating the journalistic community into not “insulting” him. This will escalate until America is under *de facto* Sharia law. Obama reacted to the slaughter of Jews in a Parisian Kosher grocery store in a similar Jew-hating fashion:

It is entirely legitimate for the American people to be deeply concerned when you have a bunch of violent, vicious **zealots** who behead people or randomly shot a bunch of **folks** in a Deli in Paris.²²⁸

There is a very strange message here. Calling these terrorists “zealots” is way out of line. A Zealot was a member of a Jewish movement of the first century AD that fought against Roman rule in Israel as incompatible with Judaism.

The gunman was after Jews, he did not randomly shoot people. That was why he chose a kosher supermarket. But what do you expect from a Jew-hating Black racist President? He reversed things. The National Defense University speech continued:

Beyond Afghanistan, we must define our effort not as a boundless “global war on terror,” but rather as a series of persistent, targeted efforts to dismantle specific networks of violent extremists that threaten America. So it is false to assert that **putting boots on the ground** is less likely to result in civilian deaths or less likely to create enemies in the Muslim world.

228. <http://www.jpost.com/Israel-News/Politics-And-Diplomacy/Obama-ignoring-reality-of-Islamic-terrorism-Deputy-minister-says-of-comments-on-Paris-attack-390807>

THE NEW CROW JIM

The results would be more U.S. deaths, more Black Hawks down, more confrontations with local populations, and an *inevitable mission creep in support of such raids that could easily escalate into new wars.*

Obama is a defeatist and has surrendered to Islam. Obama's favorite slogans, *no boots on the ground* and *mission creep*, are the dog whistle phrases that Islamist terrorists love to hear. By openly ruling out combat troops on foreign soil he is giving them the green light to commence operations. The Islamists will have to face American airpower so Obama can pretend to fight Islamism, but the jihadi will mingle with the civilian population and survive. The National Defense University speech continued:

And the best way to prevent violent extremism inspired by violent jihadists is to work with the Muslim American community *which has consistently rejected terrorism* to identify signs of radicalization and partner with law enforcement when an individual is drifting towards violence.

The Muslim community has consistently engaged in terrorism not rejected it. There been numerous incidents of devout Muslims carrying out acts of terrorism in the United States. The first World Trade Center bombing was perpetrated by New York City taxi drivers. Now Muslims from all over America leave, or attempt to leave, to join ISIS and fight alongside the Christian and American hating jihadist terrorists.

For example Hasan Edmonds, 22, an active Army National Guard specialist and a devout Muslim was arrested at Chicago Midway International Airport while attempting to fly to Cairo, Egypt. His cousin, Jonas Marcel Edmonds, 29, also a U.S. citizen, was

arrested at his Aurora home. These were dangerous traitors. Marcel Edmonds had previously served time in Georgia and was released in 2010. Islam gives thugs like Edmonds an opportunity to commit violent acts and rationalize what they do in the name of Allah. Hasan Edmonds possessed an Illinois firearm concealed carry permit. Hasan Edmonds advised,

I can own handguns shotguns and rifles but no automatic weapons or heavy machine guns. We have plenty people here who have them and hide them so we will do the same. Now it seems we've found some other brothers here with the same goals as ours akhi. Still screening them but we will let you know.

Jonas Edmonds informed UC-2 that, after Hasan Edmonds traveled, Jonas Edmonds would purchase weapons, including AK47s and grenades, from a third-party. Jonas Edmonds also informed UC-2 that he (Jonas Edmonds) was planning to attack the military installation at which Hasan Edmonds had been training.

Jonas Edmonds also advised that he wanted to conduct the attack with UC-2 and that he anticipated a "body count" of 100 to 150 individuals. Hasan Edmonds corrected Jonas Edmonds and advised that the number would be closer to 120. Hasan Edmonds offered to provide Jonas Edmonds and UC-2 with a list of the "rankings" (believed to be a reference to the officers). Hasan Edmonds also advised that they should "kill the head." Hasan Edmonds also confirmed that he would provide Jonas Edmonds with Hasan Edmonds' military uniforms. During this meeting UC-2 indicated that he would like to see the military instillation.



Obama wants the Muslim Community to become informers on their co-religionists and inform the FBI when someone starts showing signs they are becoming a jihadist. Would Jonas squeak on Hasan? In reality the Muslim community is the sea in which the jihadists swim. Hasan Edmunds stated:

All the Muslims here are watching though. I have yet to meet a Muslim yet that isn't watching and listening to what's happening in the Islamic State. There are three types here. Pro Islamic State (myself, Yunus, and others), the sleep/undecided Muslims, and the munafiqeen who support the kuffar.²²⁹

Like this one, most terrorist arrests come out of sting operations by professional informants not tips from the community. *The FBI Protecting Homeland Security in the 21st Century* report stated:

229.

https://archive.org/stream/pdfy-wPrp5_49YWou9tWE/edmonds_complaint_djvu.txt

As the FBI began its transformation into a national security organization, at the heart of that transformation was the concept of domain awareness. Domain awareness reflected the realization that the FBI could not be reactive and wait for cases to develop, it had to proactively seek to understand its environment.²³⁰

The National Defense University speech continued:

And these partnerships can only work when we recognize that Muslims are a fundamental part of the American family. *In fact, the success of American Muslims and our determination to guard against any encroachments on their civil liberties is the ultimate rebuke to those who say that we're at war with Islam.*

So here's the *Catch 22*. After the FBI receives a tip from a snitch they have to make sure they don't pull out all the stops and take down this terrorist as quickly as possible before he kills and wounds scores of people. Instead the FBI must ensure the terrorist's civil liberties are not violated. Why? So we can rebuke those who say we are at war with Islam? The people the FBI arrests in these anti-terrorist operations are Islamic. Obama's agenda: make sure the Islamists receive special treatment making it harder for the FBI to go after them. The National Defense University speech continued:

Now, all these issues remind us that the choices we make about war can impact in sometimes unintended ways the openness and freedom on

230. <https://www.fbi.gov/stats-services/publications/protecting-the-homeland-in-the-21st-century>

THE NEW CROW JIM

which our way of life depends. And that is why I intend to engage Congress about the existing *Authorization to Use Military Force*, or AUMF, to determine how we can continue to fight terrorism without keeping America on a perpetual wartime footing.

The *Authorization to Use Military Force* is now nearly 12 years old. The Afghan war is coming to an end. Core al Qaeda is a shell of its former self. Groups like al-Qaeda in the Arabian Peninsula must be dealt with, but in the years to come, not every collection of thugs that labels themselves al Qaeda will pose a credible threat to the United States. *Unless we discipline our thinking, our definitions, our actions, we may be drawn into more wars we don't need to fight, or continue to grant Presidents unbound powers more suited for traditional armed conflicts between nation states.*

So I look forward to engaging Congress and the American people in efforts to refine, and ultimately repeal, the *Authorization to Use Military Force's* mandate. And I will not sign laws designed to expand this mandate further. Our systematic effort to dismantle terrorist organizations must continue. But this war, like all wars, must end. That's what history advises. That's what our democracy demands.

This is very strange. After usurping power from Congress and the Judiciary suddenly Obama wants to relinquish the power of the Executive Branch to make war on Islamic terrorists. He knows that leaving it up to Congress makes it less likely to occur. This is all part of Obama's hidden agenda to further Islamism and destroy the State of Israel.

It is no wonder that **members of the Joint Chiefs of Staff refused to stand up during his State of the Union Address.**



But what happens next is even more revealing. Not in what Obama says but how he reacts to the traitor Susan 'Medea' Benjamin:

And given my administration's relentless pursuit of al Qaeda's leadership, there is no justification beyond politics for Congress to prevent us from closing a facility that should have never have been opened.

Susan 'Medea' Benjamin: Excuse me, President Obama -- There are 102 people on a hunger strike. These are desperate people.

Obama: So let me finish, ma'am. So today, once again I'm about to address it, ma'am, but you've got to let me speak. I'm about to address it.

Benjamin: You're our Commander-In-Chief -- you can close Guantanamo Bay.

THE NEW CROW JIM

Obama: Let me address it. Why don't you let me address it, ma'am.

Benjamin: There's still prisoners -- That includes 57 Yemenis prisoners already. Release them today.

Obama: Why don't you sit down and I will tell you exactly what I'm going to do. Thank you, ma'am. Thank you. Ma'am, thank you. You should let me finish my sentence. *Today, I once again call on Congress to lift the restrictions on detainee transfers from GTMO.* I have asked the Department of Defense to designate a site in the United States where we can hold military commissions. I'm appointing a new senior envoy at the State Department and Defense Department whose sole responsibility will be to achieve the transfer of detainees to third countries. *I am lifting the moratorium on detainee transfers to Yemen so we can review them on a case-by-case basis.* To the greatest extent possible, we will transfer detainees who have been cleared to go to other countries.

Where appropriate, we will bring terrorists to justice in our courts and our military justice system. And we will insist that judicial review be available for every detainee.

Benjamin: It needs to be --

Obama: Now, ma'am, let me finish. Let me finish, ma'am. Part of free speech is you being able to speak, but also, you listening and me being able to speak. Now, even after we take these steps one issue will remain -- just how to deal with those GTMO detainees who we know have participated in dangerous plots or attacks but who cannot be

prosecuted, for example, because the evidence against them has been compromised or is inadmissible in a court of law. But once we commit to a process of closing GTMO, I am confident that this legacy problem can be resolved, consistent with our commitment to the rule of law. I know the politics are hard. But history will cast a harsh judgment on this aspect of our fight against terrorism and those of us who fail to end it.

Imagine a future -- 10 years from now or 20 years from now -- when the United States of America is still holding people who have been charged with no crime on a piece of land that is not part of our country. Look at the current situation, where we are force-feeding detainees who are being held on a hunger strike. *I'm willing to cut the young lady who interrupted me some slack because it's worth being passionate about.* Is this who we are? Is that something our Founders foresaw? Is that the America we want to leave our children? Our sense of justice is stronger than that.

Richard Reid, the shoe bomber, is, as we speak, serving a life sentence in a maximum security prison here in the United States. In sentencing Reid, Judge William Young told him, "The way we treat you is the measure of our own liberties."

Benjamin: How about Abdulmutallab -- locking up a 16-year-old -- is that the way we treat a 16-year old? (Inaudible) -- can you take the drones out of the hands of the CIA? Can you stop the signature strikes killing people on the basis of suspicious activities?

Obama: We're addressing that, ma'am.

Benjamin: thousands of Muslims that got killed will you compensate the innocent families that will make us safer here at home. I love my country. I love (inaudible) --

Obama: I think that -- and I'm going off script, as you might expect here. *The voice of that woman is worth paying attention to.* Obviously, I do not agree with much of what she said, and obviously she wasn't listening to me in much of what I said. But these are tough issues, and the suggestion that we can gloss over them is wrong.

Susan Benjamin is the Jewish founder of *Code Pink*, an organization determined to destroy Israel. She and her husband are Communists who once lived in Cuba. *Code Pink* is into gay issues which clash with the Islamists she supports. Islamists are obligated to throw homosexuals off the highest building or stone them to death. They have also glued homosexuals anuses shut.

Susan Benjamin traveled to Fallujah in late 2004 to donate \$600,000 worth of *humanitarian aid* to the Islamic State fighters who had just *killed 51 Americans and wounded 560 more* earlier that month.²³¹ Operation Phantom Fury in Fallujah was the heaviest US urban combat since the Vietnam War. Al-Baghdadi was a recipient of Susan's generosity yet Obama says *the voice of that woman is worth paying attention to.*

On **September 9, 2013** Obama again used the catch phrase which really means *I will let the Islamists take over the world* when he said "***I will not put American boots on the ground in Syria.***"

231. https://en.wikipedia.org/wiki/Code_Pink

This was again a signal to jihadists the world over that they would not have to fight American troops who were vastly superior to them. It was *surrender* to radical Islam that had far reaching consequences and led to the formation of the Islamist State.

By **January 2014** the Islamic State fighters threatened key Iraqi cities. The city of Fallujah, forty miles from Baghdad taken from insurgents by the Marines was overrun by the Islamist State.

In January 2014 President Obama was asked in an interview with *The New Yorker* what he thought of the ISIL or ISIS terrorist group.

***If a JV team puts on Lakers uniforms,
that doesn't make them Kobe Bryant***

By this time the Islamic State fighters were threatening Baghdad. Aside from that, why compare a terrorist group to a basketball team? This plays down the deadliness of ISIS.



On *May 28, 2014* Obama gave more encouragement to the Islamic State when he delivered his “surrender speech” at West Point Military Academy. Obama:

You are the first class to graduate since 9/11 ***who may not be sent into combat in Iraq or Afghanistan.*** Now, this question isn't new. *At least since George Washington served as Commander-in-Chief, there have been those who warned against foreign entanglements that do not touch directly on our security or economic well being.* Today, according to self-described realists, conflicts in Syria or Ukraine or the Central African Republic are not ours to solve. And not surprisingly, after costly wars and continuing challenges here at home, that view is shared by many Americans. But to say that we have an interest in pursuing peace and freedom beyond our borders is not to say that every problem has a military solution.²³²

This might sound good to the cadets in audience however Obama plans to cut back on the “peacetime” military and some might be out of a job. Obama says he is going to stay out of Syria, the birthplace of ISIS and the country that ISIS controls half of. But there is no direct mention of ISIS by Obama at all. Just a pledge that no matter what happens in Iraq no American troops will be sent there. This is a dangerous form of isolationism. The Atlantic and Pacific oceans served as great barriers for America in George Washington’s time. There were no ICBMs, no air travel that could be a vector for biological weapons such as the designer viruses developed by microbiologists in the Islamic State. A report compiled by the European Union stated:

Threats can emanate from highly qualified individuals who have access to sensitive information and materials, and who possess the necessary

232. <https://www.Whitehouse.gov/the-press-office/2014/05/28/remarks-president-united-states-military-academy-commencement-ceremony>

expertise. ISIL/Da'esh has recruited and continues to recruit hundreds of foreign fighters, including some with degrees in physics, chemistry, and computer science, who experts believe have the ability to manufacture lethal weapons from raw substances. The Commission has drawn particular attention in this respect to returnees from Syria and other radicalized individuals, who have access to, or work in, sensitive areas. The group controls large swathes of territory, approximately the size of Belgium, stretching, in Syria, from near the Turkish border to close to the Lebanese border, and to the east, in Iraq, to close to Baghdad. This gives the group a significant strategic advantage. It offers it a haven in which it can function freely and shelter from third parties seeking to disrupt its activities. Through activities centered in the parts of Syria and Iraq that are under its control, ISIL/Da'esh has access to 'extraordinary' levels of funding. A Reuters study published in October 2014 estimated that ISIL/Da'esh possessed assets of more than US \$2 trillion, with an annual income amounting to US \$2.9 billion. The group earns about US \$40 million a month from illicit oil sales.

There were no international terrorists being schooled abroad and returning to their home lands, no Da'esh. It was a whole different ballgame so why quote George Washington?

Essentially what Obama is saying here is that if something is not an immediate threat to America just ignore it and let it play itself out. Not every problem has a military solution so forget about counter-insurgency - something that could have ended a problem like ISIS just as it was getting its insurgency started. Obama continued:

THE NEW CROW JIM

Since World War II, some of our most costly mistakes came not from our restraint, but from ***our willingness to rush into military adventures without thinking through the consequences*** -- without building international support and legitimacy for our action; without leveling with the American people about the sacrifices required. Tough talk often draws headlines, but war rarely conforms to slogans. As General Eisenhower, someone with hard-earned knowledge on this subject, said at this ceremony in 1947: "War is mankind's most tragic and stupid folly; to seek or advise its deliberate provocation is a Black crime against all men."

Obama is saying that the neo-cons (many of whom were Jewish) provoked America into invading Iraq with lies about WMD programs. By quoting Eisenhower's speech in post-war America he implied that the neo-cons are guilty of a crime against humanity similar to that of the Nazis.

On the other hand when issues of global concern do not pose a direct threat to the United States, when such issues are at stake -- when crises arise that stir our conscience or push the world in a more dangerous direction but do not directly threaten us -- then *the threshold for military action must be higher*. This leads to my second point: For the foreseeable future, the most direct threat to America at home and abroad remains terrorism. But a strategy that involves invading every country that harbors terrorist networks is naïve and unsustainable. But as I said last year, in taking direct action we must uphold standards that reflect our values.

That means taking strikes only when we face a continuing, imminent threat and only where there is no certainty -- there is near certainty of no civilian casualties. For our actions should meet a simple test: We must not create more enemies than we take off the battlefield.

When Obama stated “then the threshold for military action must be higher” he really meant *during my Presidency no matter what goes down in the world there will be no troops fighting a ground war overseas*. “That means taking strikes only when we face a continuing, imminent threat and only where there is **no** certainty - - there is **near** certainty of no civilian casualties. For our actions should meet a simple test: We must not create more enemies than we take off the battlefield.” If the criterion is NO certainty then there would be no strikes what-so-ever because there are always going to civilian casualties in a war. He had to suppress his true desires and change no to near certainty. Obama is implementing his hidden agenda of not fighting Islamism by saying he won’t authorize any action where one hair on a Muslim civilian’s head is harmed.

According to Obama it was American military action in the Iraqi battlefield that was responsible for creating the enemy ISIS because of atrocities committed by American troops, torture of prisoners in American run prisons like Abu Ghraib. Islam was responsible for creating ISIS but Obama will never admit this because he doesn’t want to be “at war with Islam.”

Obama gave this speech in **late May 2014**. In **June 2014** Mosul, a city of 2 million fell to ISIS and is now under Shar’ia law. Christians were beheaded, terrorist prisoners freed and hundreds of thousands people fled. Amnesty International reported:

The group that calls itself the Islamic State (IS) has carried out ethnic cleansing on a historic scale in

northern Iraq. Amnesty International has found that the IS has systematically targeted non-Arab and non-Sunni Muslim communities, *killing or abducting hundreds, possibly thousands, and forcing more than 830,000 others to flee the areas it has captured since 10 June 2014.*²³³

The only reference to ethnic cleansing that I can find that Obama ever made is “Even here, in Europe, we’ve seen ethnic cleansing in the Balkans that shocked the conscience.” Widespread ethnic cleansing accompanied the war in Bosnia and Herzegovina (1992–95), large numbers of Bosnian Muslims were forced to flee their homes and were expelled by Bosnian Serbs. Obama is not worried about the ethnic cleansing of Christians in Iraq and Syria. He is a pretend Christian. He has gone to church 18 times during his nearly five years in the White House, according to Mark Knoller of CBS News, while his predecessor, Bush, attended 120 times during his eight years in office.

No wonder seventy-two percent of U.S. Muslims approved of the job President Barack Obama was doing as president during the first six months of 2014, higher than any other U.S. religious group. In **August 2010** a national survey by the Pew Research Center found that nearly one-in-five Americans (18%) said Obama is a Muslim.²³⁴

233.

https://www.es.amnesty.org/uploads/media/Iraq_ethnic_cleansing_final_for_matted.pdf

234. <http://www.pewforum.org/2010/08/18/growing-number-of-americans-say-obama-is-a-muslim/>

The beheading of James Foley by ISIS didn't faze Obama as he was all smiles as he played golf after making a speech about Foley.²³⁵ Obama was more upset when Michael Brown was killed. Obama:

Well, once ISIL got into Mosul, that posed a big problem because there's no doubt that they were able to capture *some* weapons and resources that they've then used to finance additional operations. And at that stage, we immediately contacted the Iraqi government.²³⁶

After Mosul fell Obama contacted the Iraqi government. What decisive action! *Some* resources? ISIS made off with 500 billion Iraqi dinars \$425 million and an unknown quantity of gold bullion. By **July 2014** Abu Bakir al-Baghdadi came out of hiding and delivered a Sermon in Mosel, a city that ISIS now fully controlled. Here is was Scum-Baghdadi had to say:

Oh Muslims, Allah created us so that we would worship Him alone and establish His religion. Allah said: "I only created the jinn and Mankind that they would worship Me" [Quran 51:56]. Allah commanded us to fight His enemies and to wage Jihad for His sake, in order to achieve this purpose and to establish His religion. Allah said: "Fighting is ordained for you, although it is hateful to you" [Quran 2:216]. Allah also said: "*Fight them until*

235.

<http://www.telegraph.co.uk/news/worldnews/barackobama/11080525/Obama-playing-golf-after-Foley-beheading-was-bad-optics.html>

236. <https://www.Whitehouse.gov/the-press-office/2014/08/28/statement-president>

there is no more strife, and religion is for Allah alone" [Quran 2:193]. Oh people, the religion of Allah will not be established, and the purpose for which Allah created us will not be achieved, unless the law of Allah is instated and observed, and unless the Islamic punishments are implemented. This can be accomplished only through power and might.

This is the foundation of Islam: A book of guidance and a sword that defends it. Allah has bestowed victories and conquests upon your brothers, the mujahideen. After long years of Jihad and perseverance, fighting the enemies of Allah, Allah has enabled them to accomplish their goal. Thus, they hastened to declare the establishment of their Caliphate and the appointment of an imam. *This is a duty incumbent upon the Muslims – a duty that was neglected for centuries and was not implemented.* Many Muslims were ignorant of this duty. Muslims who ignore this duty are committing a sin. They must always strive to carry out this duty. Lo and behold, they have now carried out this duty, blessings and gratitude be to Allah.

I was put to the test by this heavy responsibility with which I was entrusted. I have been appointed your wali²³⁷ yet I am not the best among you, nor am I better than you.

237. In Islam, the phrase wali Allah can be used to denote one vested with the "authority of God": Only Allah is your Wali and His Messenger and those who believe, those who keep up prayers and pay the poor-rate while they bow.—Quran, sura 5.

I shall promise you what Allah promised His believing servants: "Allah has promised those among you who believe and do righteous deeds that *He will make them rulers on the land, as He made those before them rulers.*"²³⁸

Baghdadi is an Islamist version of Adolf Hitler. His Caliphate is equivalent to a Third Reich: On August 19, 1934 a plebiscite was put to the German people, asking whether Hitler shall now become head of state as Führer and Reich Chancellor. More than 38 million voters said yes (and more than 4 million had the courage to say no). At the party rally in Nuremberg in September 1934 Hitler declared that the Nazi revolution was now complete; and "in the next thousand years there will be no other revolution in Germany." Thus began the concept of the Third Reich, the Thousand-Year Reich, completing the trio of the First Reich (the Holy Roman Empire) and the Second Reich (achieved by Bismarck for the Hohenzollern dynasty). The new Hitler Baghdadi preached "He will make them rulers on the land, as He made those before them rulers."

He will instate for them their religion, which He has chosen for them. He will replace their fear with security. "They shall worship Me, not associating anything with Me. Whoever disbelieves henceforth – these are the sinners" [Quran 24:55].

This is the entire verse:

Allah has promised to those of you who believe and do good deeds that He will certainly appoint them Khalifa in the earth as He appointed successors those before them, and that certainly **He shall establish for**

238. http://www.memritv.org/clip_transcript/en/4335.htm

them their religion which He has chosen for them, and that certainly after their fear He will give them security in exchange; *they shall worship Me, not associating anything with Me; and whosoever disbelieves after this, they are those who are transgressors.*²³⁹

Khalifa or Khalifah is an Arabic name or title which means "successor" or "steward." It most commonly refers to the leader of a Caliphate. Baghdadi has appointed himself the Caliphate, the new Representative ruler of Allah. By doing so he is associating himself with Allah, putting himself on the same level with an alleged supreme being, which is a grave sin. Baghdadi continued:

If you want what Allah has promised, wage Jihad for His sake, incite the believers, and persevere through these hardships. If only you knew what reward, honor, elevation, and glory there is in Jihad – in this world and in the Hereafter – none of you would be remiss in setting out to wage Jihad. Oh Allah, give strength to Islam and the Muslims, humiliate polytheism and the polytheists, and support Your servants, the monotheistic mujahideen, all over the world.

What is most interesting about this speech is the fact that Mohammad is not mentioned once, only Allah. Baghdadi thinks he is the successor to Mohammad! He even wants to end Haj, a pillar of Islam: "If Allah wills, we will kill those who worship stones in Mecca and destroy the Kaaba. People go to Mecca to touch the stones, not for Allah."

239. [http://shiamawaddatbooks.com/Knowing%20Infallibles%20\(a.s.\).doc](http://shiamawaddatbooks.com/Knowing%20Infallibles%20(a.s.).doc)

In **August 2014** Obama began airstrikes against ISIS which he calls ISIL (the Islamic State of Iraq and the Levant) rather than ISIS. This is inaccurate name since it is not just Syria and Iraq they want to enslave, it is not just the Levant, it's the entire world.²⁴⁰ Some have suggested he did this just to confuse matters and make it look like there were two groups, not one, up to no good.

On **August 28, 2014** Obama made his now infamous *We Have No Strategy* speech.

Now, ISIS poses an immediate threat to the people of Iraq and to people throughout the region. As I've said, rooting out a cancer like ISIS will not be quick or easy, but I'm confident that we can and we will, working closely with our allies and our partners. *For our part, I've directed Secretary Hagel and our Joint Chiefs of Staff to prepare a range of options.* I'll be meeting with my National Security Council again this evening as we continue to develop that strategy. And I've been consulting with members of Congress, and I'll continue to do so in the days ahead.²⁴¹

Every option except for the one option that would work: Boots on the ground. Obama created ISIS and hopes that one day it will destroy Israel so he will never take decisive action against it.

We will continue to support *a moderate opposition* inside of Syria in part because we have to give people inside of Syria a choice other than ISIL or Assad. And I don't see any scenario in which Assad

240. Today the Levant consists of the island of Cyprus, Israel, Jordan, Lebanon, Syria, Palestine, and part of southern Turkey.

241. <https://www.Whitehouse.gov/the-press-office/2014/08/28/statement-president>

THE NEW CROW JIM

somehow is able to bring peace and stability to a region that is majority Sunni and has not so far, you know, shown any willingness to share power with them or in any kind of significant way deal with the longstanding grievances that they have there.

Obama stated that Syria has to be stabilized in some fashion because we are caught between and rock and a hard place, ISIS and Assad. So the answer, according to Obama, is to support Sunni Islamists, the Moslem Brotherhood, also known as “the moderate opposition.” Before Obama’s Arab Spring destabilized Syria, the country was no threat to the United States. Which is more important for America’s security, getting rid of Assad or wiping out the ISIS that is intent on taking over the world?

I don't want to put the cart before the horse. *We don't have a strategy yet.* I think what I've seen in some of the news reports suggests that folks are getting a little further ahead of where we're at than we currently are.

Obama continues to let this ISIS cancer spread. In June 2015 he said it again:

We don't yet have a complete strategy because it requires commitments on the part of the Iraqis, as well, about how recruitment takes place, how that training takes place. And so the details of that are not yet worked out.²⁴²

On Sunday, September 7, 2014 Obama stated:

242. <https://www.Whitehouse.gov/the-press-office/2015/06/08/remarks-president-obama-press-conference-after-g7-summit>

I'm preparing the country to make sure that we deal with a threat from ISIL. Keep in mind that this is something that we know how to do. We've been dealing with terrorist threats for quite some time. This administration systematically dismantled Al Qaeda in the FATA. We just yesterday announced the fact that we had taken out the top leader of Al-Shabaab the terrorist-- organization in Somalia.²⁴³

This is simply a lie. Terrorism thrives in the Federally Administered Tribal Territories of Pakistan. And how many know what "FATA" means anyway? Donna Brazil, a close associate of Obama, didn't know what a caliphate was! In December 2014 Pakistani Taliban attacked an army-run school in Peshawar, a FATA capital, killing 141 people, 132 of them children.

There is not going to be an announcement about U.S. ground troops. This is not the equivalent of the Iraq war. What this is similar to the kinds of counter-terrorism campaigns that we've been engaging in consistently over the last five, six, seven years.

Obama will engage in the same type of counterterrorism campaigns that failed in Yemen, which is currently experiencing a civil war between the Shiites and Sunnis and in Libya, where the secularists are fighting the Islamists? The US has closed its Embassies in both Libya and Yemen.

I want everybody to understand that we have not seen any immediate intelligence about threats to the homeland from ISIL. That's not what this is about. What it's about is an organization that, if allowed to control significant amounts of territory, to amass

243. <http://www.nbcnews.com/meet-the-press/president-barack-obamas-full-interview-nbcs-chuck-todd-n197616>

THE NEW CROW JIM

more resources, more arms to attract more foreign fighters, including from areas like Europe, who have Europeans who have visas and then can travel to the United States unimpeded, that over time, that can be a serious threat to the homeland. We're not looking at sending in 100,000 American troops.

Obama is lulling America into a false sense of security. "I want everybody to understand that we have not seen any immediate intelligence about threats to the homeland from ISIL." In September 2014 a law enforcement bulletin warned that Islamic State fighters had increased calls for "lone wolves" to attack U.S. soldiers in America, citing one tweet that called for jihadists to find service members' addresses online and then "show up and slaughter them."²⁴⁴ In December 2014 the FBI and DHS recommend that current and former members of the military review their online social media accounts for any information that might serve to attract the attention of ISIL [ISIS] and its supporters.²⁴⁵

And sure enough some filthy Muzzie scum, Mohammad Youssef Abdul-azeeza, who heard this edict not by going to an ISIS website, but through the media, carried out the orders of the Islamic State. The media searched for a motive citing his drug use and alcohol abuse yet his motive was jihad. The *New York Times* depicted him as mentally ill; however he was able to earn a degree in Electrical Engineering, a tough college major.

244. <http://www.foxnews.com/world/2014/09/17/law-enforcement-bulletin-warned-isis-urging-jihad-attacks-on-us-soil/>

245. <http://abcnews.go.com/International/isis-threat-home-fbi-warns-us-military-social/story?id=27270662>

There had been prior attacks against military recruitment centers. In Little Rock, Ark., a jihadist attack ended in death. Abdulhakim Mujahid Muhammad opened fire as he drove by a recruiting office, in Chattanooga, Tennessee killing one soldier and wounding another. Muhammad, born Carlos Leon Bledsoe, was an American who converted to Islam as an adult. He is now serving a sentence of life in prison.²⁴⁶ The media was looking high and low but downplaying the obvious when it came to a motive: Defense Secretary Ashton Carter said at a memorial service for the five service members killed by Abdulazeez, a *mureed*²⁴⁷ of Anwar al-Awlaki, that:

The meaning of their killing is yet unclear, and what combination of disturbed mind, violent extremism, and hateful ideology was at work, we don't know. Perhaps it will never be fully known, let alone fathomable, by all who have the decency and conscience to value their fellow human beings.

His motives are clear from his writing but Ashton Carter is beholden to Obama, his Commander and Chief, who doesn't want to link the killing to Islam. Vice President Joe Biden, however, had this to say:

These perverse ideologues, warped theocrats, they may be able to inspire a single lone wolf to commit a savage act, but they can never, never threaten who we are. When this ***perverted jihadist*** struck, everyone responded.

“Perverse” means contrary to the accepted or expected

246. <http://www.washingtonpost.com/news/morning-mix/wp/2015/07/17/from-tenn-to-times-square-military-recruiting-centers-prove-easy-targets/>

247. Follower or disciple

standard or practice. “Ideologues” means an adherent of an ideology, especially one who is uncompromising and dogmatic. This is a reference to Anwar al-Awlaki. These “warped theocrats” finally a reference to Islam “can inspire a single lone wolf” single lone wolf? Al-Awlaki has inspired countless “lone wolves” to practice jihad. Then Biden goes on to call Abdulazeez a “perverted jihadist” which makes no sense because normal jihadists are no better.²⁴⁸

Returning to Obama’s NBC interview: Obama knew attacks like the ones that occurred in Paris were inevitable yet he refused to prevent it by sending in American troops to put an end to The Islamic State:

And what I want people to understand, though, is that over the course of months, we are going to be able to not just blunt the momentum of ISIL. We are going to systematically degrade their capabilities. We’re going to shrink the territory that they control. And ultimately we’re going to defeat ‘em.

Chuck Todd: Long way, long way from when you described them as ***a Junior Varsity team.***

Obama: Well, I--

Chuck Todd: Was that bad intelligence or your misjudgment?

Obama: *Keep-- keep-- keep in mind I wasn’t specifically referring to ISIL. I’ve said that, regionally,*

248. <http://www.wsj.com/articles/biden-calls-chattanooga-shooter-a-perverted-jihadist-1439675449>

there were a whole series of organizations that were focused primarily locally. Weren't focused on homeland, because I think a lot of us, when we think about terrorism, the model is Osama bin Laden and 9/11. And the point that I was--

Chuck Todd: You don't believe these people--

Obama: Not yet. But they can evolve. And I was very specific at that time. What I said was, not every regional terrorist organization is automatically a threat to us that would call for a major offensive. *But what is absolutely clear in ISIL, which started as Al Qaeda in Iraq and arose out of the U.S. invasion there and was contained because of the enormous efforts of our troops there then shifted to Syria, has metastasized, has grown.* And now we're going to have to deal with--

Chuck Todd: They're not a Junior Varsity team.

Obama: ***Well, they're not a Junior Varsity team.*** But keep in mind that we anticipated some of these problems in the speech that I gave at West Point you know, several months ago, where I specifically said, our goal should not be to think that we can occupy every country where there's a terrorist organization. The boots on the ground have to be Iraqi. And the question is, when are the moderate Sunni states and leadership going to work systematically to say,

“What ISIL represents isn’t Islam.” It is an abortion, a distortion, an abomination that has somehow tied Islam to the kind of nihilistic thinking that any civilized nation should eliminate.

THE NEW CROW JIM

First Obama denies he was referring to ISIL with his junior varsity remark. The he admits it. He is nothing but a liar who is more interested in assigning blame for the successes of ISIL than he is in fighting it. “But what is absolutely clear in ISIL, which started as Al Qaeda in Iraq and arose out of the U.S. invasion there and was contained because of the enormous efforts of our troops there then shifted to Syria, has metastasized, has grown.” ISIL started in Syria as a spin-off of Al-Nusra, an al Qaeda franchise. Obama is repeating the same old chant – it was the U.S. invasion of Iraq that created this cancer on humanity, and the *Islamic State* has nothing to do with following the dictates of Mohammad who spread his so-called religion at the point of a sword. Instead of taking responsibility for the rise of ISIL Obama blames “the moderate Sunni states” for its rise.

It was premature withdrawal that created the Islamic State. Leon Panetta, Obama’s Director of the CIA wrote that Obama did not pressure the Iraqi government enough when it came to leaving a residual force in Iraq in case any problems arose that the Iraqi Army couldn’t handle. The major sticking point was if the troops would be under Iraqi or U.S. Military law. On July 12, 2007 George Bush stated:

I know some in Washington would like us to start leaving Iraq now. To begin withdrawing before our commanders tell us we are ready would be dangerous for Iraq, for the region, and for the United States. It would mean surrendering the future of Iraq to al Qaeda. It would mean that we'd be risking mass killings on a horrific scale. ***It would mean we'd allow the terrorists to establish a safe haven in Iraq to replace the one they lost in Afghanistan.*** It would mean increasing the probability that American troops would have to return at some later date to

confront an enemy that is even more dangerous. The fight in Iraq is part of a broader struggle that's unfolding across the region.²⁴⁹

While giving a speech on **September 3, 2014** in Estonia Obama claimed that after beating the Islamists into the ground he could *manage* what was left of the Islamic State - which meant recognizing it and dealing with it.

Our objective is clear, and that is to degrade and destroy ISIS so that it's no longer a threat not just to Iraq but also the region and to the United States. If we are joined by the international community, we can continue to shrink ISIL's sphere of influence, its effectiveness, its financing, and its military capabilities to the point where *it is a manageable problem*.²⁵⁰

We can shrink the cancer but it will always be there so we better figure out a way to *manage* the disease. At this NATO meeting Obama called for the obliteration of ISIS but the only military maneuvering that took place was agreeing to form a strike force to be used against the Russians. Obama continued:

But what I've said from the start is, is that this is not going to be a one-week or one-month or six-month proposition. *Because of what's happened in the vacuum of Syria, as well as the battle-hardened elements of ISIS that grew out of al Qaeda in Iraq*

249. <http://www.washingtonpost.com/wp-dyn/content/article/2007/07/12/AR2007071200937.html>

250. <https://www.Whitehouse.gov/the-press-office/2014/09/03/remarks-president-obama-people-estonia>

*during the course of the Iraq war, it's going to take time for us to be able to **roll them back**.*

Note the use of **roll back** the Islamic State. *The New York Times*, the semi-official newspaper of the Obama administration reported that Obama's advisors said it might take three years to roll back ISIS. That would give the Islamist State time to develop ABC weaponry – Atomic, Biological and Chemical and use them against anyone who will not knuckle under to its brand Islamism. An ABC attack could lead to a military coup in the United States. It could lead to political instability and assassination. Utter chaos as Washington and New York City are destroyed. This is paranoia? The FBI does not think so:

The overarching goal of the Weapons of Mass Destruction Directorate's (WMDD) 2015-2020 Strategic Plan is to leverage integrated intelligence and operational capabilities to work closely with domestic and international government and private partners to prevent and neutralize weapons of mass destruction (WMD) threats. A key objective is to "systematically identify novel or emerging science and technology with potential WMD applications."²⁵¹

These psychopaths pose a far greater threat than was posed by the USSR. Godless Soviet communists did not believe they were going to heaven after they died. It was the vacuum in the Islamists heads that created ISIS along with the vacuum in Syria. Yet because of his hidden agenda Obama refuses to obliterate ISIS before they pose a WMD threat to the U.S.

251. <http://spotidoc.com/doc/1078545/protecting-the-homeland-in-the-21st-century>

WEAPONS OF MASS DESTRUCTION: FOR REAL THIS TIME



Obama has a poor track record when it comes to destroying WMDs. This is what he told the White House Press Corps in August 2012:

I have, at this point, not ordered military engagement in the situation [in Syria]. But the point that you made about chemical and biological weapons is critical. That's an issue that doesn't just concern Syria; it concerns our close allies in the region, including Israel. It concerns us. We cannot have a situation where chemical or biological weapons are falling into the hands of the wrong people.

We have been very clear to the Assad regime, but also to other players on the ground, that a red line for us is we start seeing a whole bunch of chemical weapons moving around or being utilized. That would change my calculus. That would change my equation.

Q. So you're confident it's somehow under -- it's safe?

THE NEW CROW JIM

The President: In a situation this volatile, I wouldn't say that I am absolutely confident. What I'm saying is we're monitoring that situation very carefully. We have put together a range of contingency plans.

We have communicated in no uncertain terms with every player in the region that that's *a red line for us* and that there would be enormous consequences if we start seeing movement on the chemical weapons front or the use of chemical weapons. That would change my calculations significantly. All right, thank you, everybody.²⁵²

In an interview with Gwen Ifill in August 2013, Obama stated:

There is a reason why there is an international norm against chemical weapons. There's a reason why consistently, you know, the rules of war have suggested that the use of chemical weapons violates Geneva Protocols. So they're different, and we want to make sure that they are not loose in a way that ultimately, could affect our security.

And if, in fact, we can take limited, tailored approaches, not getting drawn into a long conflict, not a repetition of, you know, Iraq, which I know a lot of people are worried about – *but if we are saying in a clear and decisive but very limited way, we send a shot across the bow saying, stop doing this*, that

252. <https://www.Whitehouse.gov/the-press-office/2012/08/20/remarks-president-White-house-press-corps>

can have a positive impact on our national security over the long term, and may have a positive impact on our national security over the long term and may have a positive impact in the sense that chemical weapons are not used again on innocent civilians.²⁵³

That shot across the bow was never fired even though Assad used chemical weapons against the civilian and military opposition.

Leon Panetta recalled:

On August 21, 2013 Assad's forces released a devastating attack with rockets carrying the chemical saran. 1429 people including 426 children were killed. At that point both the President and John Kerry who had taken over as Secretary of State on January 1 made it clear that they were leaning toward limited military action, but the President Obama vacillated, first indicating that he was prepared to order some strikes, then retreating and agreeing to submit the matter to Congress. The later was, as he well knew an almost certain way to scotch any action. The result I felt, was a blow to American credibility. When the President, as commander and chief, draws a red line it is critical that he act if the line is crossed.²⁵⁴

Obama wimped out. It took Vladimir Putin to convince Assad to dispose of his stockpile of chemical weapons.

253. http://www.pbs.org/newshour/bb/White_house-july-dec13-obama_08-28/

254. http://www.amazon.com/Worthy-Fights-Memoir-Leadership-Peace/dp/1594205965/ref=sr_1_1?s=books&ie=UTF8&qid=1437828446&sr=1

THE NEW CROW JIM

One of Obama's advisors called Netanyahu a chicken shit²⁵⁵ but who really is the chicken shit? Who is the world class coward in the face of genocide?

Who is the only one of two presidents never to serve in the armed forces and defend this country?

Who is putting America at grave risk of an ABC attack that is inevitable if Obama prevents the military from cleaning out this terrorist training camp called the Islamic State? The longer the *no boots on the ground* policy remains in effect the more likely there will be an ABC attack.



Figure 12. Typical side view of a cruciform shaped bunker.

There is evidence that crude chemical weapons are still available at al-Muthanna Chemical Weapons Plant where they are stored in bunkers. Chlorine bombs might be being manufactured in its reconstructed satellite facilities.

The al-Muthanna mega-facility was the flagship of Iraqi's chemical weapons development program. The CIA reported:

255. <https://www.washingtonpost.com/news/volokh-conspiracy/wp/2014/10/29/some-background-to-the-chickenshit-controversy/>

During its peak in the late 1980s to early 1990s, it amassed mega-bunkers full of chemical munitions, and provided Iraq with a force multiplier sufficient to counteract Iran's superior military numbers. Two wars, sanctions and UNSCOM oversight reduced Iraqi's premier production facility to a stockpile of old damaged and contaminated chemical munitions (sealed in bunkers), a wasteland full of destroyed chemical munitions, razed structures, and unusable war-ravaged facilities.

After 1994 al-Muthanna (Samarra' Chemical Weapons Production and Storage Facility as well as its satellite facilities) underwent strategic changes in key researchers and production. ***Resources were spent trying to rebuild the satellite facilities;*** however, the site Al Muthanna (Samarra' Chemical Weapons Production and Storage Facility) remained essentially abandoned.

In 1998 Al Tariq State Establishment took over all remaining remnants at Al Muthanna and in June 2014 ISIS took control. What was done with Al Muthanna under the Al Tariq State Establishment? Were so of the facilities rebuilt or was in left to rot?

It is these satellite facilities that might be producing chemical warfare devices like the 120-millimeter chemical mortar shell that struck sandbag fortifications at a Kurdish military position near Mosul Dam on June 21, 2015 and caused several Kurdish fighters near where it landed to become ill. The *New York Times* reported:

The shell did not explode and was recovered nearly intact on June 29, 2015 by Gregory Robin, a former French military ordnance disposal technician who now works for Sahan Research, a think tank

partnered with Conflict Armament Research, a private organization that has been documenting and tracing weapons used in the conflict. The research groups noted that the mortar shell appeared to have been manufactured in an “ISIS workshop by casting iron into mold method. The mortar contains a warhead filled with a chemical agent, most probably chlorine.”²⁵⁶

The Islamic State is already a laboratory for terrorism. Muhsin al-Fadhli’s gang was assembling explosive clothes and toothpaste tubes there.²⁵⁷

The Islamic State seized uranium after they overran a university complex in Mosul in their swift offensive across northern Iraq.²⁵⁸ That material can be made into a radiological dispersion device. In September 2014 the US had made a deal with Baghdad to detect and recover sensitive nuclear materials before the Islamists get to them but how reliable is the Iraqi Government?

In a letter sent to UN Secretary General Ban Ki-moon in July 2014, Iraq's Permanent Representative to the UN Ambassador Muhammad Ali Hakim said that his government had lost control of the Muthanna Chemical Weapons complex north of Baghdad on June 11, 2014 and that ISIS militants now have the chemical substances stored at the facility in their possession. Hakim pointed out in his letter that the Iraqi government could no longer meet its international obligations to destroy the toxic substances, because of

256. <http://www.nytimes.com/2015/07/18/world/middleeast/islamic-state-isis-chemical-weapons-iraq-syria.html>

257. <https://www.stratfor.com/weekly/threat-toothpaste-bomb>

258. <http://nuclear-news.net/2014/07/12/page/2/>

the poor security situation in the region. Mohammed Ali Al-Hakim singled out two bunkers at the facility, 13 and 41, as being of particular concern.

According to a UN report compiled after the departure of UN inspectors in October 2014, bunker 41 contained “2,000 empty 155 mm artillery shells contaminated with the chemical warfare agent mustard, 605 one-ton mustard containers with residues, and heavily contaminated construction material.”

The CIA reported:

The precursor and agent production area at Al Muthanna was not completely destroyed during Desert Storm. Portions of the mustard (blister agent) production and storage area survived. The VX and Tabun production (nerve agent) facilities were incapacitated. The Iraq Survey Group conducted multiple exploitations of the Al Muthanna site to determine whether old chemical weapons, equipment, or toxic chemicals had been looted or tampered with since the last UN visit to the site. The Iraq ***Survey Group is unable to unambiguously determine the complete fate of old munitions, materials, and chemicals produced and stored there.*** The matter is further complicated by the looting and razing done by the Iraqis.

With regard to the state of al-Muthanna at the time that the report was composed (2007), it observes that Stockpiles of chemical munitions are still stored there. The most dangerous ones have been declared to the UN and are sealed in bunkers. Reports indicate that the chemical installations remaining from the

era of former Iraqi President Saddam Hussein have toxic chemicals or remnants of them.²⁵⁹

In August 2015 ISIS jihadi were accused of using mustard gas in the battle around Syria's shattered second city of Aleppo. Doctors working in Marea, 25km north of the city, said they had treated more than 30 patients with suppurating blisters in the wake of ISIS shelling. Testing was conducted on the spent shell. "The result of the test revealed they [ISIS] has used mustard gas,"

Brigadier General Sirwan Barzani, commanding officer of the infantry division in the area said. Barzani said a mortar barrage carried a gas his fighters had not seen before in ISIS attacks. He said the Peshmerga affected by the chemical agent had breathing problems and skin injuries consistent with mustard gas.

Based on this, Barzani said tests were carried out by experts from one of the countries that belong to the international coalition to fight the Islamic State, or ISIS. Earlier, Barzani had said a team of US and French experts had collected samples to explain what could have caused the burns and respiratory issues. Initial tests by the United States confirmed the chemical agent was mustard gas.

Obama continued his Estonian NATO speech:

Our objective is clear, and that is to degrade and destroy ISIS so that it's no longer a threat not just to Iraq but also the region and to the United States.

ISIL is a threat to almost every country in the world not just the Middle East and the United States. ISIS represents a re-birth of Islam on a global scale, like an outbreak of a long dormant disease. On **September 11, 2014** Obama stated:

259. https://www.cia.gov/library/reports/general-reports-1/iraq_wmd_2004/chap5_annxB.html

At this moment the greatest threats come from the Middle East and North Africa, where radical groups exploit grievances for their own gain. And one of those groups is ISIS which calls itself the Islamic State. *Now let's make two things clear: ISIS is not Islamic. No religion condones the killing of innocents, and the vast majority of ISIS's victims have been Muslim.*²⁶⁰

Islam does condone the killing of innocents with certain exceptions. "The Holy Prophet (may peace be upon him) has given clear instructions about the behavior of the Muslim army. He observed: Set out for Jihad in the name of Allah and for the sake of Allah. Do not lay hands on the old verging on death, on women, children and babes."²⁶¹ Everyone else is dead halal meat. So far the victims of ISIS have been mostly Muslims because they defeated the Iraqi army.

After that ISIS went after any and all non-Sunni Muslims. The tentacles of ISIS will already reach out to the United States, Europe, Israel, everywhere there are Muslims who follow the Qu'ran letter for letter. Obama continued:

And ISIS is certainly not a state. It was formerly al-Qaida's affiliate in Iraq and has taken advantage of sectarian strife and Syria's civil war to gain territory on both sides of the Iraq-Syrian border. It is recognized by no government nor by the people it subjugates.

260. <https://www.Whitehouse.gov/the-press-office/2014/09/10/statement-president-isil-1>

261. http://shamriya.blogspot.com/2010/04/jihad-terrorists-and-muslims_19.html

THE NEW CROW JIM

ISIS is a terrorist organization, pure and simple. And it has no vision other than the slaughter of all who stand in its way.

Obama states the ISIS is opportunistic, oppressive a murderous terrorist organization that started in Iraq. It did not start in Iraq, it started in Syria and spread to Iraq after Obama withdrew the United States troops. Obama continued:

As I have said before, these American forces will not have a combat mission. *We will not get dragged into another ground war in Iraq.* But they are needed to support Iraqi and Kurdish forces with training, intelligence and equipment.

But I want the American people to understand how this effort will be different from the wars in Iraq and Afghanistan. *It will not involve American combat troops fighting on foreign soil.* This counterterrorism campaign will be waged through a steady, relentless effort to take out ISIL wherever they exist, using our air power and our support for partners' forces on the ground.

According to Obama ISIS is evil incarnate but on the other hand he is going to make sure ISIS exists by refusing to send in ground troops to eliminate it. Having the power to end evil and not using it makes you evil. This is the first speech where Obama didn't use the phrase *no boots on the ground*. The American people are beginning to realize this is a dog whistle phrase meaning we will ultimately let the Muslims rule. Instead he spelled it out "no American combat troops fighting on foreign soil." Obama Estonian NATO speech continued:

And our own safety, our own security depends upon our willingness to do what it takes to defend this nation and uphold the values that we stand for -- timeless ideals that will endure long after those who offer only hate and destruction have been vanquished from the Earth. May God bless our troops and may God bless the United States of America.

This *vanquished from the Earth* is all talk. No boots on the ground, no boots on the earth. Obama is allowing the Islamic State to grow by pretending to attempt to defeat them with airstrikes. He has this to say at MacDill Air Force Base on **September 17, 2014**:

In a world where technology provides a small group of killers with the ability to do terrible harm, it is America that has the capacity and the will to mobilize the world against terrorists -- including the group in Syria and Iraq known as ISIS. *Our intelligence community, as I said last week, has not yet detected specific plots from these terrorists against America.* But its leaders have repeatedly threatened America and our allies. And right now, these terrorists pose a threat to the people of Iraq, the people of Syria, the broader Middle East including our personnel, our embassies, our consulates, our facilities there. And if left unchecked, they could pose a growing threat to the United States.

The American forces that have been deployed to Iraq do not and will not have a combat mission. They will support Iraqi forces on the ground as they fight for their own country against these terrorists.

As your Commander-in-Chief, I will not commit you and the rest of our Armed Forces to fighting another ground war in Iraq. After a decade of massive ground deployments, it is more effective to use our unique capabilities in support of partners on the ground so they can secure their own countries' futures. And that's the only solution that will succeed over the long term.²⁶²

What if our partners can't secure their own countries and ISIS takes over Iraq? We already know that the Iraqi army can't deal with ISIS so no matter how many advisors Obama sends to Iraq it will do little good. It is the Shi'ite militias who are motivated to fight the Sunni ISIS. Obama is waiting for a terrorist attack to occur before he will act against ISIS in a meaningful fashion. He is giving ISIS the breathing room it needs to develop a WMD. He is putting hundreds of thousands of American lives in danger. Why? Obama's *no boots on the ground* mantra is part of his hidden agenda. On **September 28, 2014** Obama stated:

Well, what I'm saying is that we are assisting Iraq in a very real battle that's taking place on their soil, with their troops. But we are providing air support. And it is in our interest to do that because ISIL represents sort of a hybrid of not just the terrorist network, but one with territorial ambitions, and some of the strategy and tactics of an army. This is not America against ISIL. This is America leading the international community to assist a country with whom we have a security partnership with. To make sure that they are able to take care of their business.²⁶³

262. <https://www.Whitehouse.gov/the-press-office/2014/09/17/remarks-president-macdill-air-force-base>

263. <http://www.cbsnews.com/news/president-obama-60-minutes/>

Obama refuses to fight ISIL: “This is not America against ISIL.” By April 2015 the only airstrikes being carried out against ISIL were by the United States. Obama continued:

Well I think, our head of the intelligence community, Jim Clapper, has acknowledged that I think they underestimated what had been taking place in Syria.

He is blaming ISIS on Clapper. We don’t know what was contained in the reports that were given to Obama about the situation in Syria. Obama might have ignored them.

But what I also said, and this was two years ago and a year ago, is that you have *regional groups with regional ambitions and territorial ambitions*. And what also has not changed is the kind of violent, ideologically driven extremism that has taken root in too much of the Muslim world.

ISIS “Ideologically driven extremism?” Ideology is a system of ideas and ideals, especially one that forms the basis of economic or political theory and policy. ISIS is a theocracy: a form of government in which God or a deity is recognized as the supreme ruler. What Obama is referring to is not so much an extreme form of Islam as it is a go by the book form, a violent and aggressive Islam filled with mutilations, beheadings, stonings, mass executions: the way Mohammad would have liked it if he were here in person today. Obama continued:

And this week, in my speech to the United Nations General Assembly, I made very clear *we are not at war against Islam. Islam is a religion that preaches*

peace and the overwhelming majority of Muslims are peaceful.

Most Muslims disregard Mohammad's instructions to make jihad. But even if 1% doesn't that is a million jihadi.

But in the Muslim world right now, there is a cancer that has grown for too long that suggests that it is acceptable to kill innocent people who worship a different God.

And that kind of extremism, unfortunately, means that we're going to see for some time the possibility that in a whole bunch of different countries, radical groups may spring up, particularly in countries that are still relatively fragile, where you had sectarian tensions, where you don't have a strong state security apparatus.

Obama compares ISIS to a cancer. But Obama still refuses to launch a surgical strike to remove the cancer before it spreads to the rest of the world. He is saying that America should brace itself and resign itself to a whole bunch of "radical groups springing up" as the Arab world disintegrates, which he will never admit was a result of his Cairo University speech and the Arab Spring Obama supported.

That's why what we have to do is rather than play whack-a-mole and send U.S. troops wherever this occurs, we have to build strong partnerships. We have to get the international community to recognize this is a problem. We've got to get Arab and Muslim leaders to say very clearly, "*These folks do not represent us. They do not represent Islam,*" and to speak out forcefully against them.

America has to play whack-a-mole because whack-a-mole is counterinsurgency stopping a bunch of devil worshipping rodents before they erode Western civilization. But Obama is a defeatist and isolationist with a hidden agenda so counter-insurgency is out of the game. Notice Obama never named the countries he wants to denounce ISIS. Because they are allies like Qatar. However it is private donors there and in other Gulf States that use ISIS as a surrogate to kill Shi'ites, AKA rejectionists.

[ISIS has] now created an environment in which young men are more concerned whether they're Shiite or Sunni, rather than whether they are getting a good education or whether they are able to, you know, have a good job.

The Sunni / Shiite schism has been going on for 500 years and was not the invention of ISIS. There were always Sunnis who felt Shiites were heretics and must be killed and vice versa. Sunnis believe that after Mohammad croaked many of his followers wanted to return to the "jinn" the pre-Islamic period so they made Moe's nephew, Ali, into a diety. This allowed them to return to practices like temporary marriage and self-flagellation.

Many of them are poor. Many of them are illiterate and are therefore more subject to these kinds of ideological appeals.

Some are poor but many jihadists come from middle class backgrounds for example Ramzi Yousef.

And, you know, the beginning of the solution for the entire Middle East is going to be a transformation in ***how these countries teach their youth***. What our military operations can do is to just check and roll

THE NEW CROW JIM

back these networks as they appear and make sure that the time and space is provided for a new way of doing things to begin to take root. But it's going to take some time. And in the meantime, what I can...

How are these countries going to teach their youth? The Mohammadans will never stop teaching their children the Koran. "But it's going to take some time." How much time? The military, most notably Martin Dempsey Head of the Joint Chiefs of Staff, realizes that if left in a safe operational area the Islamists will develop WMDs.

"This is an organization that has an apocalyptic end-of-days strategic vision that will eventually have to be defeated." He also takes issue with Obama defeatist Hare Krishna like chant, No Boots on the Ground.

At this juncture, our advisors are intended to help the Iraqis develop a mindset for the offensive and the actions to match it. Our military advisors will help the Iraqis conduct campaign planning, arrange for enabler and logistics support, and coordinate Coalition contributions. *To be clear, if we reach the point where I believe our advisors should accompany Iraqi troops on attacks against specific ISIL targets, I will recommend that to the President.* ISIL will ultimately be defeated when their **cloak of religious legitimacy** is stripped away and the populations on which they have imposed themselves reject them. Our actions are intended to move in that direction. This will require a sustained effort over an extended period of time. It is a generational problem. And we should expect that our enemies will adapt their tactics as we adjust our approach.

CLOAK OF RELIGIOUS LEGITIMACY

ISIS hides under no cloak of religious legitimacy. It is legitimate Islam. During the time of the Islamic caliphate much of the world was under the yoke of Shari'a law as the inhabitants of the Islamic State are now. The caliphate lasted for 1,300 years until it was destroyed by the West in 1924. From the time of the false Prophet Muhammad in the early seventh century until the end of the Ottoman caliphate in 1924, Shari'a law operated over a wide swath of humanity. At that time a passage from the Qu'ran saying that because Christians and Jews were not polytheists, they were exempt from the fate of the adherents to every other religion – convert or die.

But Jews were given *dimini* status and treated like dreck, like third class citizens. They also had to pay an extra tax just to exist. Now Islamists have been following *fatwa's* that abnegate the *respect the people of the book* clause in the Koran because their Imams have decided that everyone in the West votes for their leaders and pays taxes. This makes them combatants.

The Islamic State theocrats are the *go by the book* Islamists, practicing true Islam. The Qur'an does not make good bedtime reading. Every page depicts the punishments waiting for non-believers. This has been programmed into them. If you are a Kefir, an infidel, you get it right here on earth. The Qu'ran mentions Jihad so many times that Sheik Abdul Rahman has ruled that it is another pillar of Islam like hajj, prayer etc. If you want to learn what ISIS is about go to the source documents. You will discover a system of laws formulated in 400 AD by a thoroughly evil human being.

Islamic Law is derived from two primary sources: The Quran and Rulings of The Prophet Muhammad termed Sunnah. Some of these crimes and punishments are: adultery: death by stoning. Highway robbery: execution; crucifixion; exile; imprisonment; or right hand and left foot cut off.

Theft: right hand cut off (second offense: left foot cut off; imprisonment for further offenses).

Slander: 80 lashes.

Drinking wine or any other intoxicant: 80 lashes. Cannabis is also haraam in Islam because:

- a) It intoxicates.
- b) The Sunnah has prohibited any substance that intoxicates.
- c) It resembles khamr in the factor of inebriation.

Khamr is something that covers the brain, specifically alcohol. However, the difference in the two substances is that khamr has a prescribed punishment of 80 lashes (in an Islamic State), while cannabis or any similar intoxicant has no fixed punishment. A person guilty of such an offence in an Islamic State would be punished according to the discretion of the Court. Get a good lawyer.

CHAPTER TWENTY

OBAMA AND THE JEWS

Obama has a Jew-Hating, Whitey-Hating street mentality that he picked up when he was a Community Organizer in Chicago. He had a chip on his shoulder a mile wide. “Barack Obama was a black man that lived on the South Side of Chicago, ***who had his share of troubles catching cabs,***” Michelle Obama told *People* magazine.

The South Side of Chicago is the murder capital of the United States. Chicago recorded its 701st murder in December 2016, reaching a new milestone in savagery before year's end. Chicago has seen the number of killings increase by about 58% since 2015, according to police department data. The city is on pace to record the most murders in a year since 1997, when the police department reported 761 killings. Chicago Police have also reported more than 3,300 shooting incidents in 2016, an increase of about 49% compared to the same time last year.

Obama was elected to the Illinois State Senate in 1996. Before that he was a community organizer or agitator; however you want to look at it. Maybe back in 1996 Chicago cab drivers didn't feel like being murdered by black passengers since the streets were filling with blood all around them.

How is the Illinois state legislature going to deal with this? A recent proposal would increase the sentencing guidelines for judges deciding punishment for repeat gun felons. Instead of a range of three to 14 years, judges would hand out sentences in the range of seven to 14 years. If judges wanted to depart from that guideline, they would have to explain why.

THE NEW CROW JIM

In 2013 lawmakers failed in a high-profile attempt to raise the mandatory minimum sentence for first-time illegal gun possession offenders from one year to three years. Opponents, including Gov. Raoul, argued that measure cast too wide of a net that would result in a spike of arrests in minority communities. And as absurd as it sounds some portions of the proposal would cut penalties for people caught in possession of 100 grams or more of cocaine, heroin or fentanyl, saying the drug trade is what fuels gang violence in Chicago. The bill also calls relaxing the size of "drug free" zones from 1,000 to 500 feet, and requiring prosecutors to prove a connection between a drug crime and the protected area, such as a school, before that can be factored into toughening a sentence. In addition, the measure would remove public housing from being labeled as a protected area, in an effort to reduce the impact that law has on poor and minority communities.²⁶⁴ More institutionalization of crime and drug dealing!

Michelle Obama also stated her husband "was wearing a tuxedo at a black-tie dinner, and somebody asked him to get coffee." President Obama spoke about being mistaken for a valet. Isn't that awful being mistaken for a lowly valet whose position in life, income, social status is far less than Obama's? "There's no black male my age, who's a professional, who hasn't come out of a restaurant and is waiting for their car and somebody didn't hand them their car keys," he said, according to the interviews conducted by *People*.

The first lady also described being mistreated at a Target store in suburban Washington during a shopping trip.²⁶⁵ "Even as the first lady," she told the magazine, "during the wonderfully

264. <http://www.chicagotribune.com/news/local/politics/ct-eddie-johnson-illinois-senate-met-0310-20170309-story.html>

265. <http://www.jewsnews.co.il/2015/05/31/the-obamas-weve-been-racially-mistreated.html>

publicized trip I took to Target, not highly disguised, the only person who came up to me in the store was a woman who asked me to help her take something off a shelf.” This proved to be a lie as the Secret Service would not let anyone get close enough to her to conduct a conversation.

MAH GOLDBERG DONE RAISED MY RENT!

Why do many African-Americans hate Jews? African-Americans have been here even before there was a United States yet many have not advanced economically. Jews on the other hand came over here in the late 1800’s and prospered. Also Jew hatred has a long historical universal precedent so why shouldn’t it also be prevalent among African-Americans? One might ask if Obama hates Jews why did he have people on his staff like David Axelrod and Rahm Emanuel who are Jewish?

These were Court Jews so named because they were Jews who did favors for noblemen in exchange for prestige, social influence, and various privileges not available to other Jews. They were more concerned with preserving their political status and fortunes than in promoting the welfare of the Jewish people.

Obama’s relationship with Israel is symptomatic of the fact that many African-Americans hate Jews. When the Supreme Court struck down a law that would have allowed American parents of children born in Jerusalem to obtain passports saying the children were born in Israel Justice Clarence Thomas voted with the majority to strike down the passport provision. He traded insults with Justice Scalia, usually an ally, because like the rest of his soul brothers he hated Jews.

But Obama is good at hiding his hatred as he has an understanding of both sides of the issue. Obama was asked by Jeffery Goldberg of the *Atlantic*²⁶⁶ about the line between anti-Zionism and anti-Semitism.

You know, I think a good baseline is: Do you think that Israel has a right to exist as a homeland for the Jewish people, and are you aware of the particular circumstances of Jewish history that might prompt that need and desire? *And if your answer is no, if your notion is somehow that that **history** doesn't matter, then that's a problem, in my mind.* If, on the other hand, you acknowledge the justness of the Jewish homeland, you acknowledge the active presence of anti-Semitism that it's not just something in the past, *but it is current if you acknowledge that there are people and nations that, if convenient, would **do the Jewish people harm** because of a warped ideology.* If you acknowledge those things, then you should be able to align yourself with Israel where its security is at stake, you should be able to align yourself with Israel when it comes to making sure that it is not held to a double standard in international forum, you should align yourself with Israel when it comes to making sure that it is not isolated.

But it is not what Obama says it is was is not there that matters. Why the ambiguity when it comes to using the word Holocaust rather than "history?" Obama only mentioned the word "Holocaust" once during this lengthy interview and that was in relation to American Jews:

266. <http://www.theatlantic.com/international/archive/2015/05/obama-interview-iran-isis-israel/393782/>

And so part of the concern in the Jewish community is that, only a generation removed from the **Holocaust**, it seems that anti-Semitic rhetoric and anti-Israeli rhetoric is on the rise. And that will make people fearful.

“Do the Jewish people harm” is the understatement of the year. They want to commit genocide against the Jews until there are no more Jews left in the world. Obama continued:

But you should be able to say to Israel, we disagree with you on this particular policy. **We disagree with you on settlements. We think that checkpoints are a genuine problem. We disagree with you on a Jewish-nationalist law that would potentially undermine the rights of Arab citizens.** And to me, that is entirely consistent with being supportive of the State of Israel and the Jewish people. Now for someone in Israel, including the prime minister, to disagree with those policy positions—that’s OK too. And we can have a debate, and we can have an argument. **But you can’t equate people of good will who are concerned about those issues with somebody who is hostile towards Israel.**

And you know, I actually believe that most American Jews, most Jews around the world, and most Jews in Israel recognize as much. And that’s part of the reason why I do still have broad-based support among American Jews. It’s not because they dislike Israel, it’s not because they aren’t worried about Iran having a nuclear weapon or what Hezbollah is doing in Lebanon.

It’s because I think they recognize, having looked at my history and having seen the actions of my

administration, *that I've got Israel's back*, but there are values that I share with them that may be at stake if we're not able to find a better path forward than what feels like a potential dead-end right now.

Obama disagrees on settlements but look what happened when the settlers left Gaza? Obama disagrees on checkpoints. In other words, he wants to tell Israel how to handle its own security. The Israel Nation State Law, the most controversial parts reprinted here, never passed the Knesset. "The Right of national self-determination in the State of Israel is *unique to the Jewish People*.

This Basic Law and all other laws shall be interpreted in conformity with this provision." This means no Palestinian State will be established similar to Gaza wherein missiles can be launched and terrorist tunnels dug. Obama wants a two state solution, later qualifying his position as calling for a de-militarized Palestine - which is impossible. "The State will act to ingather the exiles of Israel and to promote Jewish *settlement* in its territory and it shall allocate resources for these purposes. The State may permit a community, including the members of a single religion or the members of a single nationality, to establish separate community *settlements*."

If there is not going to be a Palestinian terror state Israel might as well recognize the value of the settlers living in Judea Samaria. "The purpose of this Basic Law is to secure the character of Israel as the National State of the Jewish People in order to codify in a basic law the values of Israel as a Jewish democratic state in the spirit of the principles of its Declaration of Independence."

Actually the purpose of this basic law is to alter some of the principles in the Israeli Declaration of Independence in light of the fact that some Israeli-Arabs are involved in terrorism.

Israeli Foreign Minister Avigdor Lieberman suggested that they be executed for treason. The lofty principles put forth in the Israeli Declaration of the Independence don't always work when you are dealing with bloodthirsty Islamists. This is from the Israeli Declaration of Independence: "The State Of Israel will be will be based on the precepts of liberty, justice and peace taught by the Hebrew Prophets; will uphold the full social and political equality of all its citizens, without distinction of race, creed or sex."

The Arab MK (Knesset Member) Hanin Zoabi is an example of how Israeli Arabs think and why some Israelis believe they are a Fifth Column. Zoabi openly opposes the State of Israel, supports Hamas, and she published an article on Hamas's website encouraging an Islamist uprising against the Jewish state, encouraging Arab countries to help stoke a "popular uprising" against Israel, halt security coordination with the Palestinian Authority (PA) police in Judea and Samaria, and lay siege to the region.²⁶⁷ Finally the Israel Nation State Law states: "Where a court decides that a dispute cannot be resolved by existing statute, by judicial precedent, or by strict legal analogy, it shall render its decision in accordance with the principles of freedom, justice, equity, and peace *derived from Jewish civil law.*"

This last provision is very dangerous to Israeli democracy. It moves Israel closer to becoming a Jewish version of the Islamic State. What is Jewish Civil Law? The Code of Jewish Law / Kitzur Shulhan Arukh? This book is based on the laws of *Leviticus* which no longer have relevance to the Jewish people just as the antiquated laws of the Qur'an have lost their relevance. What is worse is letting the Rabbinates' Bas Dins legislate laws that codify religious coercion. Most of the Bill, however, is nothing new in Israeli society and none of Obama's business as it never passed!

267. <http://www.truthrevolt.org/commentary/torossian-treason-israeli-knesset>

Obama: *"But you can't equate people of good will who are concerned about those issues with somebody who is hostile towards Israel."* It has been this researcher's conclusions that many Whites who take up the cause of the Palestinians do so not out of love for them but as a way to destroy Israel. For instance the Nazi David Duke wrote:

The methodology through which Israel seizes Palestinian land—first by stealth, deception and then open formal takeover—is the same tactic Jewish Supremacists have used to seize control of all the major organs of political power in America and other western nations.

Duke doesn't give a rat's ass about the Palestinians he just hates Jews.

Obama's real feelings about the State of Israel were expressed during a telephone conversation with Israeli Prime Minister Netanyahu when the president told the prime minister that the United States will need to reassess its options regarding the Israel American relationship following the prime minister's new positions and comments regarding the two state solution and Israeli Arabs.

"The right-wing government is in danger," Netanyahu wrote in a Facebook post. "Arab voters are coming out in droves to the polls. Left-wing NGOs are bringing them on buses." Some of these NGO's were run by non-Israelis who were interfering with the Israeli elections.

Obama is the most anti-Israel President in America's history. He is more interested in picking a fight with Benjamin Netanyahu than stopping the spread of Islamic terrorism. He signed a treaty with Iran that could lead to the destruction of the entire Middle East and contaminate the world's food supply. The world will look

A. J. WEBERMAN

back in retrospect and wonder what self-destructive tendency caused America to elect Obama.

On his very last day in office President Obama released \$221 million in aid to the Palestinian Authority even though two Congressional committee members had placed the distribution on hold.

HISTORIA CALAMITATUM



In the early 1960's I joined the Civil Rights Movement. I picketed Woolworth and later marched to desegregate a swimming pool in Lansing, Michigan and took part in numerous other protests. What I believed would transpire as a result of the social change I worked for would be the integration of Blacks into American society in the same way other ethnic groups had been absorbed. It didn't work out the way I hoped it would. What went wrong? I have to rely partially on personal experience to answer that.

In 1957 Ebbets Field, home of the legendary Brooklyn Dodgers, was closed down and replaced by a public housing project. Brooklyn was in decline due to suburban migration of the middle class. When my friend Dr. Jonathan M. Ross's father, a liberal who designed book covers, sold his house to Jamaicans many people in the neighborhood, my father among them, got really upset with him.

I told my dad that if someone had the money to buy the property they should not be discriminated against because they are Black. I don't know where the Ross' moved to but I bet it was a step upward. I do know that Jonathan currently lives in community that is .7% Black.²⁶⁸ His father left the less affluent Jews to deal with the consequences of his actions.

The neighborhood, now known as Lefferts Gardens, started turning African-American, mainly Jamaican. There were burglaries, muggings, murders, rapes, dope, abandoned buildings and an exodus of Jews leaving the rent controlled apartments they had inhabited for decades. My mother was one of them. The reason was Black crime.

There were a few holdouts. One of them was Rabbi Feit who lived in a single family house. He was repeatedly assaulted on his way to the Prospect Park Jewish Center because the Jamaicans, some of whom were right out of the rainforest and had never seen a Jew in their entire lives, thought he had valuables in his tsfillin bag when all that was in there was religious paraphernalia. He left the neighborhood after a home invasion in which he nearly lost his life. This is real life. This is my experience not something I read about.

After the Blacks replaced the Jews, Italians and Irish at my high school, Erasmus Hall, the school became a jungle with students hanging out the windows as if the building was a tenement. In 1994, the city created three new high schools at the Erasmus Hall Campus. The move did not improve things. There were muggings and knifings²⁶⁹ in the building, with many overage students who did not attend class.

268. <http://www.city-data.com/city/Norwich-Vermont.html>

269. <http://www.nydailynews.com/new-york/brooklyn/teen-charged-attempted-murder-stabbing-alfredo-allen-brooklyn-school-article-1.994850>

THE NEW CROW JIM

Test scores and graduation rates remained low, and all three Erasmus schools appeared on the state's list of failing schools. Should I not learn from life experience? Should I dismiss this as an aberration? Was my neighborhood in Brooklyn unique?

Despite young Whites moving back into Lefferts Gardens and driving out poorer Blacks things haven't changed much since the neighborhood tipped. Erasmus is still a zoo with its several of its female "students" beating on another girl in a nearby McDonalds as the other students cheered.²⁷⁰ As for Ebbets Houses the FBI reported "For almost a decade, the defendant Yasser Ashburn led a Six Tre Folk Nation set of 20 to 25 members that operated in the Ebbets Field Houses, a New York City public housing community in the Crown Heights neighborhood of Brooklyn. From approximately 2007 until their arrests in 2011 and 2012, the defendants were responsible for numerous acts of gang-related violence, including homicides, non-fatal shootings, and robberies in and around Crown Heights and Flatbush, and elsewhere in the tri-state area."²⁷¹ The gang, a rival of the Crypts, terrorized Ebbets Houses.

In July 2015 there was a drive-by shooting of a 17 year old Black at the corner of Flatbush Avenue and Lincoln Road. This was where I worked in a Toy Store owned by the Kronheim family staunch advocates of Civil Rights. They never expected something this. In August some African-American shot up a hookah bar a few blocks away. The liberal Jews could not foresee that, given freedom, about one third of Black males have either chosen to live a life of crime or have been born into it.²⁷²

270. <http://pix11.com/2015/03/11/video-4-teens-viciously-beat-girl-in-brooklyn-mcdonalds-as-crowd-cheers/>

271. <https://www.fbi.gov/newyork/press-releases/2015/the-leader-and-two-members-of-folk-nation-gang-operating-in-the-ebbets-field-houses-in-brooklyn-convicted-of-racketeering-and-murder>

272. <http://www.naacp.org/pages/criminal-justice-fact-sheet>

A. J. WEBERMAN

I am sure I will be labeled a racist for placing responsibility on African-Americans for the current state of race relations and Black crime in America – but I consider myself a cosmic umpire, calling it the way it is. There is no doubt in my mind that making the antecedents of the thugs that destroyed my old neighborhood into heroes hurts anti-racism. Setting a new record for murders during National Black History Month doesn't help either.